

TITAN INDUSTRIES, INC.

a world of products for the world of water

CALL US TODAY!

PO Box 308
East Hwy 30
Paxton, Nebraska 69155
800-658-4086
308-239-4281
308-239-4474 (fax)

11555 S. Highway 283
Dodge City, Kansas 67801
800-658-4078
620-225-6201
620-225-1171 (fax)

1203 S.E. Grand Blvd.
Oklahoma, City, Oklahoma 73129
800-749-8659
405-677-1290
405-677-1296 (fax)

112 Grant - Aurora Industrial Park
Aurora, Nebraska 68818
800-255-4188
402-694-4188
402-694-4511 (fax)

1912 West Harry
Wichita, Kansas 67213
866-323-9111
316-262-9111
316-262-9119 (fax)

Titan Industries, Inc.

Index

A	Air Vent Model AVP-1, AV-150.....	I-12	Clamp, Pipe	K-01
	Air Volume Control	B-01	Clamp, Ringlock.....	I-12
	Aluminum Fittings.....	I-13	Clamps, JCM	I-15
	Aluminum Locking Well Cap.....	P-01	Cleaner	G-01
	Anodeless Poly Riser	G-23	Cocks, Frost Proof Sill	C-05
	Asphalt Repair Kit, Flowmix.....	N-06	Combo Tank Problem Solving Tips.....	B-05
	Auger Plug.....	P-01	Combo Tanks.....	B-04
B	Backflow Preventor	J-07	Compression Fittings, Brass	K-08
	Bailer	P-02	Compression Fittings, PVC	G-17
	Ball Valve	C-05	Conduit	L-04
	Bentonite	M-01	Conduit Fittings.....	L-04
	Bibb, Hose.....	C-06	Control Boxes, Franklin.....	A-09
	Black Fittings.....	E-09	Copper Coil	K-04
	Black Nipples.....	E-10	Copper Fittings.....	K-04
	Black Pipe	E-02	Copper Wire.....	L-04
	Black Tape	L-01	Coupler, Bolted/Dresser.....	I-11
	Bleeder Orifice.....	B-01	Coupler, Fresno Bolted Transition	I-11
	Bob Valve	D-07	Coupler, Wedge-Tite.....	I-11
	Bob Valve Repair Parts	D-07	Coupler, Weld-on/Starter	I-12
	Bolt Pack	G-25	Couplers & Caps, DWV	H-05
	Bolted Couplers.....	I-11	Couplers, Brass, Galvanized, Stainless Steel, PVC Drop Pipe.....	E-03
	Bottom Cap w/Check.....	D-05	Couplers, Galvanized Rod	D-01
	Bottom Check, 449.....	D-05	CPVC, Schedule 40 Fittings.....	K-10
	Bottomless Tank, Galvanized.....	D-07	CPVC, Schedule 80 Fittings.....	K-11
	Brass Compression Fittings.....	K-08	Cross Reference Guide, Drilling Supplies	M-03
	Brass Cylinder 442.....	D-05	Culvert	N-01
	Brass Cylinder 449B.....	D-05	Curb Box Adapter	C-07
	Brass Drop Pipe Couplers	E-03	Curb Stop.....	C-07
	Brass Fittings, Red/Yellow.....	K-09	Cycle Stop Valve.....	C-06
	Brass Lined, Cast Iron Cylinder A40	D-05	Cylinder, A76	D-05
	Brass Tank Tee.....	B-01	Cylinder, Brass 442.....	D-05
	Breaker, Vacuum.....	C-05	Cylinder, Brass 449B	D-05
	Breakoff Plug	C-04	Cylinder, Cast Iron Brass Lined A40	D-05
	Bronze Check Valve.....	C-04	D	
	Bronze Fittings	K-06	Dam Gates.....	I-13
	Brushes G-01		Dauber	G-01
C	Cable Guard	E-03	Detectable Blue Tape	G-25
	Cable Selection	T-04	Detectable Green Tape.....	G-25
	Calculate Annular Space	T-05	Dielectric Union.....	K-02
	Cap, Bottom w/Check.....	D-05	Dole Valve.....	C-06
	Cap, Dust	P-02	Drain Cleaner.....	K-01
	Cap, Flush Joint	P-04	Draw Band	I-12
	Cast Iron Brass Lined Cylinder A40	D-05	Dresser Coupler.....	I-11
	Cast Iron Well Seal.....	C-02	Dril Bit	M-02
	Caulk	K-01	Drilling Additives	M-02
	Cement.....	G-01	Drilling Polymers	M-01
	Cement.....	M-02	Drip Tubing	J-07
	Cement, Plumb-Tite Blue	G-01	Drop Pipe Coupler	E-03
	Centralier.....	P-01	Drop Pipe, Certalok.....	E-04
	Certalok PVC Fittings	G-17	Ductile Fittings & Accessories.....	G-24
	Certalok, Drop Pipe	E-04	Ductile Iron Fittings	G-25
	Check Poppet 442.....	D-05	Dust Cap	P-02
	Check Valve, Bronze.....	C-04	DWV Couplers & Caps	H-05
	Check Valve, Flomatic.....	C-04	DWV Schedule 40 PVC Fittings.....	H-01
	Check, 449, 461, 652	D-05	E	
	Check, Bottom 449.....	D-05	Egress Window Well	N-04
	Cherne Test Ball Plug	K-02	Electrodes	L-03
	Chips, Subtrol.....	L-02	Enviroflex	P-02
	Chlorinator.....	O-02	F	
	Chlorine.....	O-02	F&W Pumps.....	A-06
	Cistrin Storage Tank.....	D-07	Fiberglass Rod.....	D-01
	Cistrin Storage Tank.....	H-12	Filtersock.....	P-02
	Clamp, Flush Joint Holding.....	P-02	Fittings, 100# PIP Gasketed	I-09
			Fittings, 100# Solvent Weld	I-07

Fittings, 80# PIP Gasketed Fittings	I-05	Galvanized Rod Couplers	D-01
Fittings, 80# PIP Solvent Weld	I-03	Galvanized Tank Nipple	E-08
Fittings, Aluminum	I-13	Galvanized Tank Tee	B-01
Fittings, Black	E-09	Garden Hose Fittings	K-09
Fittings, Brass Compression	K-08	Gasketed Sewer & Drain Fittings	H-10
Fittings, Bronze	K-06	Glue	G-01
Fittings, Certalok Drop Pipe	E-04	Goulds Pumps	A-01
Fittings, Certalok PVC	G-17	Grout, Bentonite	M-01
Fittings, Conduit	L-04	Guard, Cable	E-03
Fittings, Copper	K-04		
Fittings, Ductile	G-24	H Hanger Strap	K-01
Fittings, Ductile Iron	G-25	HDPE Fittings	G-22
Fittings, DWV Schedule 40 PVC	H-01	Heat Shrink Kits	L-01
Fittings, Fusion	G-22	Holding Clamp, Flush Joint	P-02
Fittings, Galvanized	E-05	Hoop Assembly	D-07
Fittings, Garden Hose	K-09	Hose Bibb	C-06
Fittings, Gasketed Sewer & Drain	H-10	Hunter Sprinklers	J-01
Fittings, HDPE	G-22	Hydrant	C-01
Fittings, Lowhead PIP	I-01	Hydrant, Fittings	C-01
Fittings, PVC Insert Fittings	G-18	Hydrant, Parts	C-01
Fittings, PVC Schedule 40	G-02	Hydraul-Ex	M-01
Fittings, PVC Schedule 80	G-10		
Fittings, Schedule 40 CPVC	K-10	I Infiltrators	H-12
Fittings, Schedule 80 CPVC	K-11	Insert Fittings, PVC	G-18
Fittings, SDR 21	G-09	Insert Fittings, Steel	G-19
Fittings, Sewer & Drain	H-07	Insta-Vis	M-01
Fittings, Surface	I-14	Intake Screen	D-05
Flange, Ductile Iron	G-25	IPS Bolted Coupler	I-11
Float Switch, Open Tank	L-02	Irrigation Valve	I-13
Flomatic, Check Valve	C-04	Irrigation Wire	L-03
Floor Flange, Galvanized	E-06	Irritrol Controlers	J-04
Flow Meter	I-13		
FlowMix Asphalt Repair Kit	N-06	J JCM Clamps	I-15
Flush Joint Cap	P-04	Joint Tape	K-01
Flush Joint Casing	P-04	J-Plug	P-01
Flush Joint Holding Clamp	P-02	Junction Box	L-02
Flush Joint Lifting Plugs	P-02		
Flush Joint Plug	P-04	K Kam Kap	P-01
Flush Joint Point	P-04	Kenyon Tools	N-02
Flush Joint Screen	P-04	Kitec	K-12
Foot Valve	C-05		
Franklin Submersible Motors	A-08	L Leather, Windmill	D-06
Friction Loss Chart	T-01	Lifting Plugs, Flush Joint	P-02
Frost Proof Sill Cocks	C-05	Light Slip Caps	G-09
Fusion Fittings	G-22	Lime	M-02
		Little Giant Pumps	H-12
G Galvanized Bottomless Tank	D-07	Locking Well Cap	P-01
Galvanized Culvert	N-01	Lowhead PIP Fittings	I-01
Galvanized Drop Pipe Couplers	E-03		
Galvanized Fittings	E-05	M Manhole Cover	P-03
Galvanized Floor Flange	E-06	Masterlock	P-01
Galvanized Meter Box/Tank Pit	N-01	Measuring Wheel	N-03
Galvanized Nipples	E-07	Meter Box	N-01
Galvanized Pipe	E-01		
Galvanized Pump Rod T&C	D-01	N Nipple, Brozne	K-06

CALL US TODAY!

PO Box 308
East Hwy 30
Paxton, Nebraska 69155
800-658-4086
308-239-4281
308-239-4474 (fax)

112 Grant - Aurora Industrial Park
Aurora, Nebraska 68818
800-255-4188
402-694-4188
402-694-4511 (fax)

11555 S. Highway 283
Dodge City, Kansas 67801
800-658-4078
620-225-6201
620-225-1171 (fax)

1203 S.E. Grand Blvd.
Oklahoma, City, Oklahoma 73129
800-749-8659
405-677-1290
405-677-1296 (fax)

1912 West Harry
Wichita, Kansas 67213
866-323-9111
316-262-9111
316-262-9119 (fax)

Titan Industries, Inc.

Index

Nipple, Tank Galvanized	E-08	Pumps, Webtrol Pumps	A-07
Nipples, Black.....	E-10	PVC Compression Fittings	G-17
Nipples, Galvanized	E-10	PVC Drop Pipe Couplers	E-03
Nipples, Schedule 80	G-15	PVC Fittings, Insert Fittings.....	G-18
Nipples, Weld-on	E-11	PVC Fittings, Schedule 40	G-02
		PVC Fittings, Schedule 80	G-10
O Oil, Windpower Windmill.....	D-01	PVC Valves.....	G-20
Open Tank Float Switch	L-02		
Outlet Boxes.....	L-02	R Rainbird Sprinklers.....	J-01
		Rakes.....	N-02
P Packer, Well System	I-16	Red Brass Fittings.....	K-09
PAC-N-VAC.....	I-16	Red Jacket Pumps.....	A-04
Padlock.....	P-01	Regulator, Pressure	C-05
Panel, Subtrol Pump	L-02	Ringlock Clamp.....	I-12
Pex Riser.....	K-01	Rod Couplers, Galvanized	D-01
PIP Bolted Coupler.....	I-11	Rod, Fiberglass.....	D-01
PIP Pipe Dimensions.....	I-17	Rod, Galvanized Pump T&C.....	D-01
PIP, 100# Gasketed Fittings.....	I-09	Rope, Safety	E-03
PIP, 100# Solvent Weld Fittings	I-07		
PIP, 80# Gasketed Fittings.....	I-05	S Sacrete	M-02
PIP, 80# Solvent Weld Fittings	I-03	Safety Rope	E-03
PIP, Lowhead Fittings	I-01	Sand	M-01
Pipe Clamp.....	K-01	Schedule 40 CPVC Fittings.....	K-10
Pipe Cutter, Internal	P-01	Schedule 40 PVC Fittings	G-02
Pipe, Black	E-02	Schedule 40, DWV PVC Fittings.....	H-01
Pipe, Galvanized	E-01	Schedule 80 CPVC Fittings.....	K-11
Pitless Adapter	C-02	Schedule 80 Nipples.....	G-15
Pitless Control Module	B-06	Schedule 80 PVC Fittings	G-10
Pitless Unit	C-02	SDR 21 Fittings.....	G-09
Plastic Well Seal.....	C-03	Septic Tanks	H-12
Plastic Wire Ties.....	E-03	Sewage Basins	H-12
Plug, Auger.....	P-01	Sewage/Sump Pumps	H-12
Plug, Flush Joint.....	P-04	Sewer & Drain Fittings	H-07
Plugs, Flush Joint Lifting.....	P-02	Sewer & Drain Fittings, Gasketed.....	H-10
Plumb-Tite Blue Cement	G-01	Shale Trap	M-02
Plunger Poppet, 442.....	D-05	Shovels	N-02
Plunger Valve, 442, 441, A40.....	D-05	Silcock	K-02
Plunger, 460, 449, 652	D-05	Silica Sand.....	M-01
Point, Flush Joint.....	P-04	Sill Cocks, Frost Proof	C-05
Polymers, Drilling	M-01	Site Marker.....	P-02
Poppet, Check 442.....	D-05	Sniftner Air Valve	B-02
Poppet, Plunger 442.....	D-05	Solenoid Valve	J-07
Premium Gel	M-01	Solvent Weld, 80# PIP Fittings.....	I-03
Pressure Gauge	B-02	Splice Kits	L-01
Pressure Regulator	C-05	Sprinklers.....	J-01
Pressure Regulator	J-07	Sprinklers, Hunter	J-01
Pressure Relief Valve.....	B-01	Sprinklers, Rainbird.....	J-01
Pressure Relief Valve.....	I-12	Sprinklers, Toro.....	J-03
Pressure Switch	B-02	Sta Kons	L-01
Pressure Switch	L-02	Stainless Steel Drop Pipe Couplers	E-03
Pressure Tank Specifications.....	B-03	Starter Coupler.....	I-12
Pressure Tanks, Challenger.....	B-01	Steel Fittings, Insert	G-19
Pressure Tanks, Champion.....	B-01	Storage Tank, Cistrin	D-07
Pressure Tanks, Epoxy Coated.....	B-01	Stub Tower, Windmill	D-01
Pressure Tanks, Galvanized	B-01	Submersible Motors, Franklin	A-08
Pressure Tanks, Goulds In-Line & Buried	B-01	Submersible Wire.....	L-01
Pressure Transducer.....	B-06	Subtrol Chips	L-02
Primer.....	G-01	Subtrol Pump Panel	L-02
Prinsco Pipe Wrap Tape.....	E-03	Surface Fittings	I-14
Procedure to Air up a Pressure Tank	T-03	Surface Tube Dimensions.....	I-18
Pump Rod, Galvanized T&C	D-01	Suspension Wire.....	L-03
Pump, Whaler.....	P-02	Sweat Valve	C-05
Pumps, F&W Pumps	A-06	Swing Check.....	C-05
Pumps, Goulds Pumps.....	A-01		
Pumps, Red Jacket Pumps	A-04	T Tank Nipple, Galvanized.....	E-08
Pumps, Sewage/Sump.....	H-12	Tank Pits.....	N-01

Tank, Bottomless Galvanized.....	D-07	Weld-on Nipples.....	E-11
Tank, Cistrin Storage.....	D-07	Well House, Metal Insulated	D-07
Tanks, Septic.....	H-12	Well Packer System	I-16
Tape, Black.....	L-01	Well Protector.....	P-03
Tape, Detectable Blue.....	G-25	Well Rehab Products	M-02
Tape, Detectable Green	G-25	Well Seal, Cast Iron	C-02
Tape, Joint.....	K-01	Well Seal, Plastic	C-03
Tape, Prinsco Pipe Wrap	E-03	Whaler Pump	P-02
T-Cap.....	P-01	Windmill, Complete	D-01
Techno-Cap.....	H-04	Windmill, Leather	D-06
Techno-Check	C-04	Windmill, Parts	D-02
Temperature Correction Factors	T-06	Windmill, Stub Tower	D-01
Test Ball Plug, Cherne	K-02	Windmill, Windpower Oil	D-01
Test Plug, Combo Cleanout	H-04	Window Well.....	N-04
Thrift Drain Cleaner	K-01	Wire Ties, Plastic	E-03
Titan Combo Tanks	B-04	Wire, Copper.....	L-04
Tools, Irrigation.....	N-02	Wire, Irrigation.....	L-03
Tools, Kenyon.....	N-02	Wire, Submersible.....	L-01
Tools, Sprinkler.....	J-05	Wire, Suspension	L-03
Top Cap.....	D-05	Wire, Tracer.....	L-04
Toro Sprinklers	J-03	Wire, Triplex	L-04
Torque Arrestor	E-03		
Tracer Wire.....	L-04	Y Yellow Brass Fittings.....	K-09
Trailer Parts & Supplies.....	R-01	Z Z-Drop, Irrigation	I-12
Trailer	R-03		
Triplex Wire	L-04		
Turtle Cap.....	C-03		
V Vacuum Breaker.....	C-05		
Valve Boxes.....	J-05		
Valve, Ball.....	C-05		
Valve, Bob	D-07		
Valve, Bronze Check.....	C-04		
Valve, Cycle Stop	C-06		
Valve, Dole	C-06		
Valve, Flomatic	C-04		
Valve, Foot Valve	C-05		
Valve, Irrigation.....	I-13		
Valve, Plunger 442, 441, A40.....	D-05		
Valve, Pressure Relief.....	I-12		
Valve, Solenoid.....	J-07		
Valve, Sweat.....	C-05		
Valve, Swing Check	C-05		
Valve, Techno-Check	C-04		
Valves, PVC	G-20		
Variable Speed Drive	B-06		
Visqueen.....	P-02		
VU Flow Filter.....	O-01		
W Water Equivalents Table	T-07		
Water Softner	O-01		
Watertight Cap.....	C-02		
Webtrol Pumps.....	A-07		
Wedge-Tite Coupler	I-11		
Weld-on Coupler.....	I-12		

CALL US TODAY!

**PO Box 308
East Hwy 30
Paxton, Nebraska 69155
800-658-4086
308-239-4281
308-239-4474 (fax)**

**11555 S. Highway 283
Dodge City, Kansas 67801
800-658-4078
620-225-6201
620-225-1171 (fax)**

**1203 S.E. Grand Blvd.
Oklahoma, City, Oklahoma 73129
800-749-8659
405-677-1290
405-677-1296 (fax)**

**112 Grant - Aurora Industrial Park
Aurora, Nebraska 68818
800-255-4188
402-694-4188
402-694-4511 (fax)**

**1912 West Harry
Wichita, Kansas 67213
866-323-9111
316-262-9111
316-262-9119 (fax)**

Titan Proudly

Manufactures and Distributes Quality Products

Environmental Products

Clear Bailers
 Clear PVC
 Collection Sump Screens
 Flush Threaded Casing & Screen
 ½" thru 48", 2TPI, 4TPI, & 8TPI
 Johnson PVC Screen
 Johnson Stainless Steel Screen
 Johnson Wire Wound Screen
 Manholes, PVC & Galvanized
 Pumps & Hand Pumps

Jain Pipe & Irrigation Products

Irrigation System

Emission Devices
 Filtration Equipment
 Irrigation Fittings & Accessories
 Polyethylene Hoses, Tubes

Piping System

HDPE Quick Connect
 Spiro-Flo Ribbed Screen
 Sure-Loc HDPE Pipe
 Sure-Loc PVC Column Pipe
 Spiro-Flo Ribbed Screen
 Tru-Blu Ribbed Pipe & Screen

Plumbing Products

Brass & PVC Valves
 Copper Fittings
 DWV Pipe & Fittings
 Insert Fittings
 Kitec Hot & Cold Water Flexible
 Piping System
 Poly Cisterns
 Poly Pipe
 Rubber Pipe Connectors
 Reverse Osmosis Units
 Schedule 40 Pipe & Fittings
 Schedule 80 Pipe & Fittings
 SDR35 Pipe & Fittings
 Underground Valves & Valve Boxes
 Water Softeners
 Water Filters

Pump & Well Products

Centrifugal & Jet Pumps
 Crown Pumps
 F&W Pumps
 Goulds Pumps
 Red Jacket Pumps
 Webtrol Pumps
 Certalok Casing & Drop Pipe
 Certalok Fittings
 Combo Pitless Tank
 Cycle Stop Valves
 Drop Pipe & Couplers
 Glue/Cement
 H2O Pitless Control Units

Pitless Units
 Pressure Gauges & Switches
 Pressure Tanks
 Primer/Cleaner
 Stock Tanks (Bottomless)
 Submersible Motors
 Franklin ½ hp – 100 hp

Septic Systems

Distribution Boxes
 Dosing Siphons
 Hancor Corrugated Pipe
 Infiltrator Leachfield
 Prinsco Pipe
 SDR35 Pipe & Fittings
 Septic Tanks
 Sewage & Sump Pumps
 Sump & Sewage Basins

Sprinkler Systems

Backflow Prevention
 Centrifugal Pumps
 Drip Tubing
 Emitters & Tools
 Filtration Equipment
 Hunter, Irritrol, Rain Bird & Toro
 Sprinklers
 Insert Fittings & Clamps
 Polyethylene Hoses
 Sand Filters
 Solenoid Valves
 Valve Boxes

Well Drilling, Trenching & Horizontal Boring

Fabricated Screens

½" thru 48" in PVC, HDPE & CPVC
 Easy Flo Screens
 Enviroflex Screens
 Environmental Catch Basins
 Final Filter
 High Flo Screens
 Intake Screens
 Jain Ribbed Screens
 Mega Screens
 Twin-Pack Screen
 Round Hole Perforations
 Suction Screens
 Sure-Drain, Round Hole Drainage
 Ver-ta Slot

PVC, HDPE & PIP Casing, Pipe Line & Drop Pipe

½" thru 48" all Schedules & Classes
 Distributors of:
 Centennial Plastics, LLC.
 Certainteed Corporation, P&PG
 Cresline
 Diamond Plastics, Corp.
 Harvel Plastics

IPEX
 Jain Irrigation Systems, Ltd.
 Kroy Industries, Inc.
 North American Pipe
 Northern Pipe Products, Inc.
 PW Pipe
 Rinker Materials
 Silver Line Plastics Corporation

Steel Casing & Screen

Available in several diameters
 & wall thickness
 Doerr Mild Steel Punched Screen
 Johnson Mild Steel Screen
 Johnson Wire Wound Screen

Galvanized Culverts

Bentonite, Silica Sand & Well Rehabilitation Products

Distributors of:
 Baroid
 Cetco
 Oglebay Norton Industrial Sand

PVC Fittings

Fabricated Fittings
 PIP 50, 80, 100 & 125 PSI
 Pressure Fittings
 Sch40, Sch80, DWV

HDPE Fittings

Socket Weld Fittings
 Butt Fusion Fittings
 Transition Fittings

Windmill & Cylinders

6', 8', 10' & 12' Towers
 Black & Galvanized Steel Pipe
 Brass Cylinders
 Bottomless Stock Tanks
 Complete Motors
 Fiberglass & Galvanized Pump Rod
 Leathers
 Rebuilt Windmills & Parts
 Wood Rod
 Distributors of:
 Aeromotor
 American West Windmill Company
 Dakota Windmill & Supply, Inc.

Titan Industries, Inc.

Paxton – 800/658-4086

Dodge City – 800/658-4078

Oklahoma City – 800/749-8659

Aurora – 800/255-4188

Wichita – 866/323-9111

GOULDS PUMPS

COMPLETE MODELS INCLUDE PUMP, MOTOR & CONTROL

Model		Part No.	List Price	Model		Part No.	List Price
STREAM-LINED 5G, 3W, 1PH	1/2HP, 115V	01-05G05411L		18GPM 18GS, 1PH COMPLETE	3/4HP, 230V, 3W	01-18GS07412	
	1/2HP, 230V	01-05G05412L			3/4HP, 230V, 2W	01-18GS07422	
	3/4HP, 230V	01-05G07412L			1HP, 230V, 3W	01-18GS10412	
	1HP, 230V	01-05G10412L			1HP, 230V, 2W	01-18GS10422	
	1-1/2HP, 230V	01-05G15412L			1-1/2HP, 230V, 3W	01-18GS15412	
				1-1/2HP, 230V, 2W	01-18GS15422		
STREAM-LINED 7G, 3W, 1PH	1/2HP, 115V	01-07G05411L		25GPM 25GS, 1PH COMPLETE	1HP, 230V, 3W	01-25GS10412	
	1/2HP, 230V	01-07G05412L			1HP, 230V, 2W	01-25GS10422	
	3/4HP, 230V	01-07G07412L			1-1/2HP, 230V, 3W	01-25GS15412	
	1HP, 230V	01-07G10412L			1-1/2HP, 230V, 2W	01-25GS15422	
	1-1/2HP, 230V	01-07G15412L					
5GPM 5GS, 1PH COMPLETE	1/2HP, 115V, 3W	01-05GS05411		STREAM-LINED WATER END ONLY, 5G	1/2HP	01-G00500500	
	1/2HP, 230V, 3W	01-05GS05412			3/4PH	01-G00500700	
	1/2HP, 115V, 2W	01-05GS05421			1HP	01-G00501000	
	1/2HP, 230V, 2W	01-05GS05422		1-1/2HP	01-G00501500		
	3/4HP, 230V, 3W	01-05GS07412		STREAM-LINED WATER END ONLY, 7G	1/2HP	01-G00700500	
	3/4HP, 230V, 2W	01-05GS07422			3/4HP	01-G00700700	
	1HP, 230V, 3W	01-05GS10412			1HP	01-G00701000	
	1HP, 230V, 2W	01-05GS10422		1-1/2HP	01-G00701500		
	1-1/2HP, 230V, 3W	01-05GS15412		WATER END ONLY, 5GS	1/2HP	01-GS0050500	
	1-1/2HP, 230V, 2W	01-05GS15422			3/4HP	01-GS0050700	
					1HP	01-GS0051000	
			1-1/2HP		01-GS0051500		
7GPM 7GS, 1PH COMPLETE	1/2HP, 115V, 3W	01-07GS05411		WATER END ONLY, 7GS	1/2HP	01-GS0070500	
	1/2HP, 230V, 3W	01-07GS05412			3/4HP	01-GS0070700	
	1/2HP, 115V, 2W	01-07GS05421			1HP	01-GS0071000	
	1/2HP, 230V, 2W	01-07GS05422			1-1/2HP	01-GS0071500	
	3/4HP, 230V, 3W	01-07GS07412		2HP	01-GS0072000		
	3/4HP, 230V, 2W	01-07GS07422		3HP	01-GS0073000		
	1HP, 230V, 3W	01-07GS10412		WATER END ONLY, 10GS	1/2HP	01-GS0100500	
	1HP, 230V, 2W	01-07GS10422			3/4HP	01-GS0100700	
	1-1/2HP, 230V, 3W	01-07GS15412			1HP	01-GS0101000	
	1-1/2HP, 230V, 2W	01-07GS15422			1-1/2HP	01-GS0101500	
	10GPM 10GS, 1PH COMPLETE	1/2HP, 115V, 3W	01-10GS05411		2HP	01-GS0102000	
1/2HP, 230V, 3W		01-10GS05412		3HP	01-GS0103000		
1/2HP, 115V, 2W		01-10GS05421		WATER END ONLY, 13GS	1/2HP	01-GS0130500	
1/2HP, 230V, 2W		01-10GS05422			3/4HP	01-GS0130700	
3/4HP, 230V, 3W		01-10GS07412			1HP	01-GS0131000	
3/4HP, 230V, 2W		01-10GS07422			1-1/2HP	01-GS0131500	
1HP, 230V, 3W		01-10GS10412		2HP	01-GS0132000		
1HP, 230V, 2W		01-10GS10422		3HP	01-GS0133000		
1-1/2HP, 230V, 3W		01-10GS15412		WATER END ONLY, 18GS	3/4HP	01-GS0180700	
1-1/2HP, 230V, 2W	01-10GS15422		1HP		01-GS0181000		
			1-1/2HP		01-GS0181500		
			2HP		01-GS0182000		
13GPM 13GS, 1PH COMPLETE	1/2HP, 115V, 3W	01-13GS05411		3HP	01-GS0183000		
	1/2HP, 230V, 3W	01-13GS05412		5HP	01-GS0185000		
	1/2HP, 230V, 2W	01-13GS05422					
	1/2HP, 115V, 2W	01-13GS05421					
	3/4HP, 230V, 3W	01-13GS07412					
	3/4HP, 230V, 2W	01-13GS07422					
	1HP, 230V, 3W	01-13GS10412					
	1HP, 230V, 2W	01-13GS10422					
	1-1/2HP, 230V, 3W	01-13GS15412					
	1-1/2HP, 230V, 2W	01-13GS15422					

TITAN INDUSTRIES, INC.
a world of products for the world of water

Prices are subject to change without notice.

Returns are subject to a restock fee.

Special Orders are non-returnable.

GOULDS PUMPS

Model	Part No.	List Price	Model	Part No.	List Price
WATER END ONLY, 25GS	1HP	01-GS025100	7LS, 1PH CONT.	1HP, 230V, 2W	01-07LS10422
	1-1/2HP	01-GS025150		1-1/2HP, 230V, 3W	01-07LS15412
	2HP	01-GS025200		1-1/2HP, 230V, 2W	01-07LS15422
	3HP	01-GS025300			
	5HP	01-GS025500			
WATER END ONLY, 33GS	1HP	01-GS033100	10GPM 10LS, 1PH COMPLETE	1/2HP, 115V, 3W	01-10LS05411
	1-1/2HP	01-GS033150		1/2HP, 230V, 3W	01-10LS05412
	2HP	01-GS033200		1/2HP, 115V, 2W	01-10LS05421
	3HP	01-GS033300		1/2HP, 230V, 2W	01-10LS05422
	5HP	01-GS033500		3/4HP, 230V, 3W	01-10LS07412
	7-1/2HP	01-GS033750		3/4HP, 230V, 2W	01-10LS07422
WATER END ONLY, 40GS	1-1/2HP	01-GS040150		1HP, 230V, 3W	01-10LS10412
	2HP	01-GS040200		1HP, 230V, 2W	01-10LS10422
	3HP	01-GS040300		1-1/2HP, 230V, 3W	01-10LS15412
	5HP	01-GS040500		1-1/2HP, 230V, 2W	01-10LS15422
	7-1/2HP	01-GS040750			
WATER END ONLY, 55GS	2HP	01-GS055200	18GPM 18LS, 1PH COMPLETE	3/4HP, 230V, 3W	01-18LS07412
	3HP	01-GS055300		3/4HP, 230V, 2W	01-18LS07422
	5HP	01-GS055500		1HP, 230V, 3W	01-18LS10412
	7-1/2HP	01-GS055750		1HP, 230V, 2W	01-18LS10422
				1-1/2HP, 230V, 3W	01-18LS15412
WATER END ONLY, 60GS	1-1/2HP	01-GS060150	1-1/2HP, 230V, 2W	01-18LS15422	
	2HP	01-GS060200			
	3HP	01-GS060300			
	5HP	01-GS060500			
	7-1/2HP	01-GS060750			
WATER END ONLY, 75GS	3HP	01-GS075300	25GPM 25LS, 1PH COMPLETE	1HP, 230V, 3W	01-25LS10412
	5HP	01-GS075500		1HP, 230V, 2W	01-25LS10422
WATER END ONLY, 80GS	3HP	01-GS080300		1-1/2HP, 230V, 3W	01-25LS15412
	5HP	01-GS080500		1-1/2HP, 230V, 2W	01-25LS15422
	7-1/2HP	01-GS080750			
5GPM 5LS, 1PH COMPLETE	1/2HP, 115V, 3W	01-05LS05411	WATER END ONLY, 5LS	1/2HP	01-LS005050
	1/2HP, 230V, 3W	01-05LS05412		3/4HP	01-LS005070
	1/2HP, 115V, 2W	01-05LS05421		1HP	01-LS005100
	1/2HP, 230V, 2W	01-05LS05422		1-1/2HP	01-LS005150
	3/4HP, 230V, 3W	01-05LS07412			
	3/4HP, 230V, 2W	01-05LS07422			
	1HP, 230V, 3W	01-05LS10412			
	1HP, 230V, 2W	01-05LS10422			
	1-1/2HP, 230V, 3W	01-05LS15412			
	1-1/2HP, 230V, 2W	01-05LS15422			
7GPM 7LS, 1PH COMPLETE	1/2HP, 115V, 3W	01-07LS05411	WATER END ONLY, 7LS	1/2HP	01-LS007050
	1/2HP, 230V, 3W	01-07LS05412		3/4HP	01-LS007070
	1/2HP, 115V, 2W	01-07LS05421		1HP	01-LS007100
	1/2HP, 230V, 2W	01-07LS05422		1-1/2HP	01-LS007150
	3/4HP, 230V, 3W	01-07LS07412			
10GPM 10LS, 1PH COMPLETE	3/4HP, 230V, 2W	01-07LS07422	WATER END ONLY, 10LS	1/2HP	01-LS010050
	1HP, 230V, 3W	01-07LS10412		3/4HP	01-LS010070
	1HP, 230V, 2W	01-07LS10422		1HP	01-LS010100
	1-1/2HP, 230V, 3W	01-07LS15412		1-1/2HP	01-LS010150
	1-1/2HP, 230V, 2W	01-07LS15422			
18GPM 18LS, 1PH COMPLETE	3/4HP, 230V, 3W	01-18LS07412	WATER END ONLY, 18LS	3/4HP	01-LS018070
	3/4HP, 230V, 2W	01-18LS07422		1HP	01-LS018100
	1HP, 230V, 3W	01-18LS10412		1-1/2HP	01-LS018150
	1HP, 230V, 2W	01-18LS10422			
	1-1/2HP, 230V, 3W	01-18LS15412			
25GPM 25LS, 1PH COMPLETE	1-1/2HP, 230V, 2W	01-25LS15422	WATER END ONLY, 25LS	1HP	01-LS025100
				1-1/2HP	01-LS025150
50GPM 50LS, 1PH COMPLETE	1/2HP, 115V, 3W	01-50LS05411	WATER END ONLY, 100H	5HP	01-H1000520
	1/2HP, 230V, 3W	01-50LS05412		7-1/2HP	01-H1000740
	1/2HP, 115V, 2W	01-50LS05421		10HP	01-H1001050
	1/2HP, 230V, 2W	01-50LS05422		15HP	01-H1001580
	3/4HP, 230V, 3W	01-50LS07412		20HP	01-H1002010
	3/4HP, 230V, 2W	01-50LS07422		25HP	01-H1002513
	1HP, 230V, 3W	01-50LS10412			

Prices are subject to change without notice.

Returns are subject to a restock fee.

Special Orders are non-returnable.

TITAN INDUSTRIES, INC.
a world of products for the world of water

GOULDS PUMPS

Model		Part No.	List Price	Model		Part No.	List Price
WATER END ONLY, 150H	5HP	01-H1500520		WATER END ONLY, 90L	5HP	01-L0900500	
	7-1/2HP	01-H1500730			7-1/2HP	01-L0900700	
	10HP	01-H1501040			10HP	01-L0901000	
	15HP	01-H1501560			15HP	01-L0901500	
	20HP	01-H1502080			20HP	01-L0902000	
	25HP	01-H1502510			25HP	01-L0902500	
				30HP	01-L0903000		
WATER END ONLY, 225H	5HP, 2ST	01-H2250520		WATER END ONLY, 150L	5HP	01-L1500500	
	7-1/2HP, 2ST	01-H2250720			7-1/2HP	01-L1500700	
	10HP, 3ST	01-H2251030			10HP	01-L1501000	
	15HP, 4ST	01-H2251540			15HP	01-L1501500	
	20HP, 6ST	01-H2252060			20HP	01-L1502000	
	25HP, 7ST	01-H2252570			25HP	01-L1502500	
				30HP	01-L1503000		
				40HP	01-L1504000		
WATER END ONLY, 275H	10HP, 2ST	01-H2751020		WATER END ONLY, 200L	7-1/2HP	01-L2000700	
	15HP, 3ST	01-H2751530			10HP	01-L2001000	
	20HP, 4ST	01-H2752040			15HP	01-L2001500	
	25HP, 5ST	01-H2752550			20HP	01-L2002000	
	30HP, 6ST	01-H2753060			25HP	01-L2002500	
	30HP, 7ST	01-H2753070			30HP	01-L2003000	
				40HP	01-L2004000		
WATER END ONLY, 45J	3HP	01-J0450300		WATER END ONLY, 300L	5HP	01-L3000500	
	5HP	01-J0450500			10HP	01-L3001000	
	7-1/2HP	01-J0450700			15HP	01-L3001500	
	10HP	01-J0451000			20HP	01-L3002000	
	15HP	01-J0451500			25HP	01-L3002500	
	20HP	01-J0452000			30HP	01-L3003000	
				40HP	01-L3004000		
WATER END ONLY, 70J	3HP	01-J0700300		SELF-PRIMING CENTRIFUGAL	3/4HP 1PH ODP	01-GT0700000	
	5HP	01-J0700500			1HP 1PH ODP	01-GT1000000	
	7-1/2HP	01-J0700700			1-1/2HP 1PH ODP	01-GT1500000	
	10HP	01-J0701000			2HP 1PH ODP	01-GT2000000	
	15HP	01-J0701500			3HP 3PH ODP	01-GT3030000	
	20HP	01-J0702000					
				SHALLOW WELL JET ASSEMBLY PACKAGE	1/2HP	01-FH5000000	
					3/4HP	01-FH7000000	
WATER END ONLY, 70L	3HP	01-L0700300			1HP	01-FH1000000	
	5HP	01-L0700500			1-1/2HP	01-FH1500000	
	7-1/2HP	01-L0700700		CONVERT. JET PUMP	1/2HP	01-J50000000	
	10HP	01-L0701000			3/4HP	01-J70000000	
	15HP	01-L0701500			1HP	01-J10000000	
	20HP	01-L0702000			1-1/2HP	01-J15000000	
				SHALLOW WELL JET PUMP	1/2HP	01-SJ05S0000	
EFFLUENT PUMP	1/2HP, 1PH, 115V CAST IRON	01-WE0511HH0			3/4HP	01-SJ07S0000	
	PLASTIC	01-WEP0511AC			1HP	01-SJ10S0000	
SEWAGE PUMP	1/2HP, 1PH, 115V	01-WW051100			1-1/2HP	01-SJ15S0000	

TITAN INDUSTRIES, INC.
a world of products for the world of water

Prices are subject to change without notice.

Returns are subject to a restock fee.

Special Orders are non-returnable.

NOTES

CALL US TODAY!

PO Box 308
East Hwy 30
Paxton, Nebraska 69155
800-658-4086
308-239-4281
308-239-4474 (fax)

11555 S. Highway 283
Dodge City, Kansas 67801
800-658-4078
620-225-6201
620-225-1171 (fax)

1203 S.E. Grand Blvd.
Oklahoma, City, Oklahoma 73129
800-749-8659
405-677-1290
405-677-1296 (fax)

112 Grant - Aurora Industrial Park
Aurora, Nebraska 68818
800-255-4188
402-694-4188
402-694-4511 (fax)

1912 West Harry
Wichita, Kansas 67213
866-323-9111
316-262-9111
316-262-9119 (fax)

TITAN INDUSTRIES, INC.
a world of products for the world of water

RED JACKET PUMPS

Model		Part No.	List Price	Model		Part No.	List Price	
WATER BEAR PUMP END				BIG FLO PUMP END				
5 GAL	1/2HP,AE	02-05WB05PE0		28 GAL	1-1/2HP,6DC	02-28BF15PE0		
	1HP, AE	02-05WB10PE0			2HP,8DC	02-28BF20PE0		
7 GAL	3/4HP,VB	02-07WB07PE0			3HP,11DC	02-28BF30PE0		
	1-1/2HP,VB	02-07WB15PE0			5HP,17DC	02-28BF50PE0		
10 GAL	1/2HP,BC	02-10WB05PE0		50 GAL	2HP,6FC	02-50BF20PE0		
	3/4HP,BC	02-10WB07PE0			3HP,8FC	02-50BF30PE0		
	1HP,BC	02-10WB10PE0			5HP,13FC	02-50BF50PE0		
	1-1/2HP,BC	02-10WB15PE0			7-1/2HP,FC	02-50BF75PE0		
18 GAL	3/4HP,CC	02-18WB07PE0		55 GAL	7-1/2HP,8LB6	02-55BF75PE0		
	1HP,CC	02-18WB10PE0			10HP,10LB6	02-55BF10PE0		
	1-1/2HP,CC	02-18WB15PE0		80 GAL	2HP,4EC	02-80BF20PE0		
22 GAL	1HP,GC	02-22WB10PE0			3HP,6EC	02-80BF30PE0		
	1-1/2HP,GC	02-22WB15PE0			5HP,10EC	02-80BF50PE0		
GRIZZLY PUMP END				85 GAL	7-1/2HP,6MB6	02-85BF75PE0		
8 GAL	1-1/2HP,25ST	02-08G15PE00			10HP,8MB6	02-85BF10PE0		
	12 GAL	1/2HP,8ST	02-12G058PE0			15HP,12MB6	02-85BF15PE0	
1/2HP,9ST		02-12G059PE0			20 HP,16MB6	02-85BF20PE0		
3/4HP,12ST		02-12G07PE00			140 GAL	20HP,8HB6	02-14BF020PE	
1HP, 14ST		02-12G10PE00				40HP,16HB6	02-14BF400PE	
1-1/2HP,18ST		02-12G15PE00				ENDURO PUMP & MOTOR		
20 GAL	1/2HP,5ST	02-20G05PE00			12 GAL,4"	1/2HP,9ST,4"	02-E12052093	
	3/4HP,6ST	02-20G07PE00			3W, 230V	1-1/2HP,1PH,18ST	02-E12152183	
	1HP,8ST	02-20G10PE00			20 GAL,4"	1HP,8ST	02-E20102083	
	1-1/2HP,11ST	02-20G15PE00		3W, 230V		1-1/2HP,11ST,1PH	02-E20152113	
25 GAL	1HP,7ST	02-25G10PE00		GRIZZLY PUMP & MOTOR				
	1-1/2HP,10ST	02-25G15PE00		8 GAL, 230V	1/2HP,12ST,3W	02-G08052163		
12 GAL	1/2HP,8ST	02-12E058PE0			3/4HP,16ST,3W	02-G08072163		
	1/2HP,9ST	02-12E059PE0			1HP,21ST,2W	02-G08102212		
	1-1/2HP,18ST	02-12E15PE00			1HP,21ST,3W	02-G08103212		
	2HP,23ST	02-12E20PE00			1-1/2HP,25ST,2W	02-G08152252		
	3HP,32ST	02-12E30PE00			1-1/2HP,25ST,3W	02-G08152253		
20 GAL	1HP,8ST	02-20E10PE00		12 GAL, 1/2HP,115V	8ST, 4", 2W	02-G12051082		
	1-1/2HP,11ST	02-20E15PE00			8ST, 4", 3W	02-G12051083		
	2HP,14ST	02-20E20PE00			9ST, 4", 2W	02-G12051092		
25 GAL	3HP,19ST	02-20E30PE00		9ST, 4", 3W	02-G12051093			
	12 GAL	2HP,12ST	02-25E20PE00		12 GAL, 1/2HP,230V	8ST, 4", 2W	02-G12052082	
		3HP,17ST	02-25E30PE00			8ST, 4", 3W	02-G12052083	
		5HP,28ST	02-25E50PE00			9ST, 4", 2W	02-G12052092	
				9ST, 4", 3W		02-G12052093		
				12 GAL 3/4HP,230V	12ST, 4", 2W	02-G12072122		
					12ST, 4", 3W	02-G12072123		

SEE FRANKLIN SECTION FOR CONTROL BOX PRICING

TITAN INDUSTRIES, INC.
a world of products for the world of water

Prices are subject to change without notice.
 Returns are subject to a restock fee.
 Special Orders are non-returnable.

RED JACKET PUMPS

Model		Part No.	List Price	Model		Part No.	List Price
GRIZZLY PUMP & MOTOR CONT.				WATER BEAR PUMP & MOTOR			
12 GAL, 1HP,230V	14ST, 4", 2W 14ST, 4", 3W	02-G12102142 02-G12102143		5 GAL, 1/2HP,230V	17ST, 4", 3W	02-W05052173	
12 GAL, 1-1/2HP,230V	18ST, 4", 2W 18ST, 4", 3W	02-G12152182 02-G12152183		5 GAL,3/4HP 230V,AE	21ST, 4", 2W 21ST, 4", 3W	02-W05072212 02-W05072213	
20 GAL, 1/2HP,115V	5ST, 4", 2W 5ST, 4", 3W	02-G20051052 02-G20051053		5 GAL,1HP 230V,AE	25ST, 4", 2W 25ST, 4", 3W	02-W05102252 02-W05102253	
20 GAL, 1/2HP,230V	5ST, 4", 2W 5ST, 4", 3W	02-G20052052 02-G20052053		7 GAL,1/2HP 230V	12ST,4",2W,VB	02-W07052122	
20 GAL, 3/4HP,230V	6ST, 4", 2W 6ST, 4", 3W	02-G20072062 02-G20072063		7 GAL,3/4HP 230V	16ST,4",2W,VB 16ST,4",3W,VB	02-W07072162 02-W07072163	
20 GAL, 1HP,230V	8ST, 4", 2W 8ST, 4", 3W	02-G20102082 02-G20102183		7 GAL,1HP 230V	21ST,4",2W,VB 21ST,4",3W,VB	02-W07102212 02-W07102213	
20 GAL, 1-1/2HP,230V	11ST, 4", 2W 11ST, 4", 3W	02-G20152112 02-G20152113		10GAL,1/2HP 9ST,BC	115V,4",2W 115V,4",3W 230V,4",2W 230V,4",3W	02-W10051092 02-W10051093 02-W10052092 02-W10052093	
25 GAL, 1HP,230V	7ST, 4", 3W 7ST, 4", 2W	02-G25102073 02-G25102102		10 GAL, 3/4HP,230V	12ST,4",2W,BC 12ST,4",3W,BC	02-W10072122 02-W10072123	
25 GAL, 1-1/2HP,230V	10ST, 4", 2W 10ST, 4", 3W	02-G25152102 02-G25152103		10 GAL, 1HP,230V	14ST,4",2W,BC 14ST,4",3W,BC	02-W10102142 02-W10102143	
RELAY	115V 230V	02-Z71069100 02-Z71070100		10 GAL, 1-1/2HP,230V	18ST,4",2W,BC 18ST,4",3W,BC	02-W10152182 02-W10152183	
MULTI-STAGE UTILITY PUMP	1/2HP, 115V	02-UTL005115		18 GAL, 3/4HP,230V	6ST,4",2W,CC 6ST,4",3W,CC	02-W18072062 02-W18072063	
EXTENDED WARRANTY		02-WARRANTY2		18 GAL, 1HP,230V	8ST,4",2W,CC 8ST,4",3W,CC	02-W18102082 02-W18102083	
				18 GAL,CC 1-1/2HP,230V	11ST,4",2W 1PH,11ST,4",3W	02-W18152112 02-W18152113	
				22 GAL, 1HP,230V	7ST,4",2W,GC 7ST,4",3W,GC	02-W22102072 02-W22102073	
				22 GAL, 1-1/2HP,230V	10ST,4",2W,GC 1PH,10ST,4",3W,GC	02-W22152102 02-W22152103	

Prices are subject to change without notice.

Returns are subject to a restock fee.

Special Orders are non-returnable.

TITAN INDUSTRIES, INC.
a world of products for the world of water

FLINT & WALLING PUMPS, MOTORS & PARTS

Model	Part No.	List Price	Model	Part No.	List Price	
4" SUB W/STAINLESS STEEL CASINGS						
5 GAL, 1PH PUMP & MOTOR	1/2HP, 230V, 3W 03-F05S05301		SHALLOW WELL PUMP & MOTOR	1/2 HP 3/4 HP 1 HP 03-EK05S0000 03-EK07S0000 03-EK10S0000		
10 GAL, 1PH PUMP & MOTOR	1/2HP, 115V, 3W 03-F10S05001		COVERTIBLE JET PUMP & MOTOR	1/2 HP 3/4 HP 1 HP 03-CPH050000 03-CPH070000 03-CPH100000		
	1/2HP, 230V, 3W 03-F10S05301			SHALLOW WELL EJECTOR PKG	1/2 HP 3/4 HP 1 HP 03-SW05E1630 03-SW07E1432 03-SW10E1334	
	1/2HP, 115V, 2W 03-F10S05005				DEEP WELL COVERTIBLE EJECTOR PKG	3/4 HP 1 HP 03-DW40E1726 03-DW40E1828
	1/2HP, 230V, 2W 03-F10S05305		SERVICE KIT			EK05S
	3/4HP, 230V, 3W 03-F10S07301		REPAIR PARTS			
	3/4HP, 230V, 2W 03-F10S07305		VOLUTE GASKET FOR CENTRIFUGAL C60 SERIES			
	1HP, 230V, 3W 03-F10S10301		GASKET/EJECTOR 4 WELL			
1HP, 230V, 2W 03-F10S10305		EJECTOR GASKET W/BOLTS				
1-1/2HP, 230V, 3W 03-F10S15301		DIFFUSER - CPH03, CPH05, EK05S, EK07S				
1-1/2HP, 230V, 2W 03-F10S15305		DIFFUSER - CPH07, CPH10, EK10S				
19 GAL, 1PH PUMP & MOTOR	3/4HP, 230V, 3W 03-F19S07301		DIFFUSER RUBBER - CP, CPH, CPJ, EK			
	3/4HP, 230V, 2W 03-F19S07305		SQUARE CUT RING - CPH07, CPH10, EK10S			
	1HP, 230V, 3W 03-F19S10301		SQUARE CUT RING - CPH05, EK05S, EK07S			
	1HP, 230V, 2W 03-F19S10305		IMPELLER - CPH07, EK10S			
1-1/2HP, 230V, 3W 03-F19S15301		IMPELLER - CPH10				
2HP, 230V, 3W 03-F19S20301		IMPELLER - CPH03, EK05S				
27 GAL, 1PH PUMP & MOTOR	1HP, 230V, 3W 03-F27S10301		IMPELLER - CPH05, EK07S			
	1HP, 230V, 2W 03-F27S10305					
	1-1/2HP, 230V, 3W 03-F27S15301					
	1-1/2HP, 230V, 2W 03-F27S15305					
4" SUB W/CAST IRON CASTINGS/COATED S						
10 GAL, 1PH PUMP & MOTOR	1/2HP, 115V, 3W 03-F10G05001					
	1/2HP, 230V, 3W 03-F10G05301					
	1/2HP, 115V, 2W 03-F10G05005					
	1/2HP, 230V, 2W 03-F10G05305					
	3/4HP, 230V, 3W 03-F10G07301					
19 GAL, 1PH PUMP & MOTOR	3/4HP, 230V, 2W 03-F10G07305					
	1HP, 230V, 3W 03-F19G10301					
27 GAL, 1PH PUMP & MOTOR	1HP, 230V, 2W 03-F19G10305					
	1HP, 230V, 3W 03-F27G10301					
4" SUB W/CAST IRON CASTING	1HP, 230V, 2W 03-F27G10305					
	PUMP ENDS ONLY	35 GAL, 1-1/2HP 03-F35A15000				
4" SUB W/STAINLESS STEEL CASTING						
PUMP ENDS ONLY	35 GAL, 2HP 03-F35S20000					
	55 GAL, 1-1/2HP 03-F45S1500					
	55 GAL, 2HP 03-F55S20000					
	55 GAL, 3HP 03-F55S30000					
	85 GAL, 2HP 03-F85S20000					
	85 GAL, 3HP 03-F85S30000					
	85 GAL, 5HP 03-F85S50000					

TITAN INDUSTRIES, INC.
a world of products for the world of water

Prices are subject to change without notice.
Returns are subject to a restock fee.
Special Orders are non-returnable.

NOTES

CALL US TODAY!

PO Box 308
East Hwy 30
Paxton, Nebraska 69155
800-658-4086
308-239-4281
308-239-4474 (fax)

11555 S. Highway 283
Dodge City, Kansas 67801
800-658-4078
620-225-6201
620-225-1171 (fax)

1203 S.E. Grand Blvd.
Oklahoma, City, Oklahoma 73129
800-749-8659
405-677-1290
405-677-1296 (fax)

112 Grant - Aurora Industrial Park
Aurora, Nebraska 68818
800-255-4188
402-694-4188
402-694-4511 (fax)

1912 West Harry
Wichita, Kansas 67213
866-323-9111
316-262-9111
316-262-9119 (fax)

TITAN INDUSTRIES, INC.
a world of products for the world of water

WEBTROL PUMPS

Model	HP, PH, Volts	Part No.	List Price
BRASS PUMP END	5 GAL, 3/4HP, 18ST	04-050070000	
	5 GAL, 1/2HP, 13ST	04-05G00513S	
	10 GAL, 1/2HP, 8ST	04-10G005B00	
	10 GAL, 3/4HP, 11ST	04-10G007B00	
	35 GAL, 2HP, 12ST	04-35G020000	
	45 GAL, 3HP, 11ST	04-45G03011S	
THRMOPLASTIC PUMP END	10 GAL, 1/2HP, 8ST	04-10G005000	
	10 GAL, 1HP	04-10G010P00	
	15 GAL, 1/2HP, 7ST	04-15G005000	
SS PUMP END	20 GAL, 3HP	04-20G030SS0	
	90 GAL, 5HP	04-90G050SS0	
PLASTIC PUMP & MOTOR	5 GAL, 1/2HP, 230V, 13ST, 3W, THERMOPLASTIC	04-05G00513T	
	10 GAL, 1/2HP, 230V, 8ST, 2W	04-10G0052V2	
	10 GAL, 3/4HP, 230V, 11ST, 2W	04-10G0072V2	
	10 GAL, 1HP, 230V, 14ST, 2W	04-10G0102V2	
	10 GAL, 1-1/2HP, 230V, 20ST, 2W	04-10G0152V2	
	20 GAL, 1HP, 230V, 10ST, 2W	04-20G0102V2	
	20 GAL, 1-1/2HP, 230V, 14ST, 2W	04-20G0152V2	
BRASS PUMP & MOTOR	5 GAL, 3/4HP, 230V, 18ST, 3W	04-05G0072V3	
	10 GAL, 1/2HP, 115V, 8ST, 3W	04-10G0051V3	
	10 GAL, 1/2HP, 230V, 8ST, 3W, 1PH	04-10G0052V3	
	10 GAL, 3/4HP, 230V, 11ST, 3W, 1PH	04-10G0072V3	
	10 GAL, 1HP, 230V, 14ST, 3W, 1PH	04-10G0102V3	

TITAN INDUSTRIES, INC.
a world of products for the world of water

Prices are subject to change without notice.

Returns are subject to a restock fee.

Special Orders are non-returnable.

NOTES

CALL US TODAY!

PO Box 308
East Hwy 30
Paxton, Nebraska 69155
800-658-4086
308-239-4281
308-239-4474 (fax)

11555 S. Highway 283
Dodge City, Kansas 67801
800-658-4078
620-225-6201
620-225-1171 (fax)

1203 S.E. Grand Blvd.
Oklahoma, City, Oklahoma 73129
800-749-8659
405-677-1290
405-677-1296 (fax)

112 Grant - Aurora Industrial Park
Aurora, Nebraska 68818
800-255-4188
402-694-4188
402-694-4511 (fax)

1912 West Harry
Wichita, Kansas 67213
866-323-9111
316-262-9111
316-262-9119 (fax)

TITAN INDUSTRIES, INC.
a world of products for the world of water

FRANKLIN MOTORS & CONTROLS

Model		Part No.	List Price	Model		Part No.	List Price
SUBMERSIBLE MOTOR	1/2HP	115V, 3W, 4"	05-S04930R0		7-1/2HP	230V, 1PH, 6"	05-S1197000
		115V, 2W, 4"	05-S04932R0			230V, 3PH, 4"	05-S1197040
		230V, 3W, 4"	05-S04940R0			230V, 3PH, 6"	05-S1197100
		230V, 2W, 4"	05-S04942R0			460V, 3PH, 6"	05-S1197200
		230V, 3PH, 4"	05-S0497000			460V, 3PH, 4"	05-S1197540
		460V, 3PH, 4"	05-S0497500			200V, 3PH, 6"	05-S1197800
	200V, 3PH, 4"	05-S0497800	200V, 3PH, 4"		05-S1197840		
	3/4HP	230V, 3W, 4"	05-S05940R0		575V, 3PH, 6"	05-S1197900	
		230V, 2W, 4"	05-S05942R0		10HP	230V, 1PH, 6"	05-S1297000
		230V, 3PH, 4"	05-S0597000			230V, 3PH, 6"	05-S1297100
		460V, 3PH, 4"	05-S0597500			460V, 3PH, 6"	05-S1297200
		200V, 3PH, 4"	05-S0597800			200V, 3PH, 6"	05-S1297800
			575V, 3PH, 6"			05-S1297900	
	1HP	230V, 3W, 4"	05-S06940R0		15HP	230V, 1PH, 6"	05-S1397000
		230V, 2W, 4"	05-S06942R0			230V, 3PH, 6"	05-S1397100
		230V, 3PH, 4"	05-S0697000			460V, 3PH, 6"	05-S1397200
		460V, 3PH, 4"	05-S0697500			200V, 3PH, 6"	05-S1397800
		200V, 3PH, 4"	05-S0697800			575V, 3PH, 6"	05-S1397900
1-1/2HP	230V, 3W, 4"	05-S07940R0	20HP	230V, 3PH, 6"	05-S1497100		
	230V, 2W, 4"	05-S07942R0		460V, 3PH, 6"	05-S1497200		
	230V, 3PH, 4"	05-S0797000		200V, 3PH, 6"	05-S1497800		
	460V, 3PH, 4"	05-S0797500		575V, 3PH, 6"	05-S1497900		
	200V, 3PH, 4"	05-S0797800		25HP	230V, 3PH, 6"	05-S1597100	
	575V, 3PH, 4"	05-S0797900			460V, 3PH, 6"	05-S1597200	
2HP	230V, 3W, 4"	05-S0894000	200V, 3PH, 6"		05-S1597800		
	230V, 3PH, 4"	05-S0897000	575V, 3PH, 6"		05-S1597900		
	460V, 3PH, 4"	05-S0897500	30HP		230V, 3PH, 6"	05-S1697100	
	200V, 3PH, 4"	05-S0897800			460V, 3PH, 6"	05-S1697200	
	575V, 3PH, 4"	05-S0897900		200V, 3PH, 6"	05-S1697800		
3HP	230V, 3W, 4"	05-S0994000		575V, 3PH, 6"	05-S1697900		
	230V, 3PH, 4"	05-S0997000		40HP	460V, 3PH, 6"	05-S1797200	
	460V, 3PH, 4"	05-S0997500	575V, 3PH, 6"		05-S1797900		
	200V, 3PH, 4"	05-S0997800	460V, 3PH, 8"		05-S1998200		
	575V, 3PH, 4"	05-S0997900	50HP		460V, 3PH, 6"	05-S1897200	
5HP	230V, 3W, 4"	05-S1094000			575V, 3PH, 6"	05-S1897900	
	230V, 1PH, 6"	05-S1094100		460V, 3PH, 8"	05-S2098200		
	230V, 3PH, 4"	05-S1097000		60HP	460V, 3PH, 6"	05-S1997200	
	230V, 3PH, 6"	05-S1097100			460V, 3PH, 8"	05-S2198200	
	460V, 3PH, 6"	05-S1097200	75HP		460V, 3PH, 8"	05-S2298200	
	460V, 3PH, 4"	05-S1097500		100HP	460V, 3PH, 8"	05-S2398200	
	200V, 3PH, 4"	05-S1097800			125HP	460V, 3PH, 8"	05-S2498200
	200V, 3PH, 6"	05-S1097860		150HP		460V, 3PH, 8"	05-S2598200
575V, 3PH, 4"	05-S1097900						

TITAN INDUSTRIES, INC.
a world of products for the world of water

Prices are subject to change without notice.

Returns are subject to a restock fee.

Special Orders are non-returnable.





FRANKLIN MOTORS & CONTROLS

Model	Part No.	List Price	Model	Part No.	List Price
CONTROL BOX	1/3HP, 115V	05-000330000	RUN CAPACITOR	5, 7-1/2HP	05-55327101
	1/3HP, 230V	05-000340000		3HP	05-55327102
	1/2HP, 115V	05-000430000		7-1/2, 10, 15HP	05-55328101
	1/2HP, 230V	05-000440000		1-1/2HP	05-55328102
	3/4HP, 230V	05-000540000		2HP	05-55328103
	1HP, 230V	05-000640000	MAIN OVERLOAD	2HP	05-75411112
	1-1/2HP, 230V	05-000740000		3HP	05-75406107
	2HP, 230V	05-000840000		3HP	05-75406120
	3HP, 230V	05-000940000	5HP	05-75406103	
	5HP, 230V	05-001040000	7-1/2HP	05-75406121	
7-1/2HP, 230V	05-001240000	START OVERLOAD	5, 7-1/2HP	05-75411102	
10HP, 230V	05-001340000		1-1/2HP	05-75411106	
DELUXE CONTROL BOX W/MAGNETIC CONTACTOR	2HP		05-00084MC0	1-1/2, 2HP	05-75411107
	3HP		05-00094MC0	3HP	05-75411108
	5HP	05-00104MC0	START CAPACITOR	3HP	05-75463111
	7-1/2HP	05-00124MC0		1/2HP, 230V	05-75464105
10HP	05-00134MC0	3HP		05-75464106	
15HP	05-00144MC0	1, 1-1/2, 2HP	05-75464113		
OVERLOAD KIT	1/3HP, 115V	05-305100901	3/4HP, 230V	05-75464118	
	1/3HP, 230V	05-305100902	1/2HP, 115V	05-75464201	
	1/2HP, 115V	05-305100903	2HP	05-75468115	
	1/2HP, 230V	05-305100904	5HP	05-75468118	
	3/4HP, 230V	05-305100905	7-1/2, 10HP	05-75468119	
1HP, 230V	05-305100906	MOTOR LEAD	2W, 48"	05-AW2480000	
CAPACITOR & OVERLOAD ASSEMBLY	1-1/2HP, 230V		05-51033946	3W, 48"	05-AW3480000
	1/3HP, 115V		05-51033973	3W, 100"	05-AW3100000
	1/3HP, 230V		05-51033974	6"W/GROUND	05-AW2850000
	1/2HP, 115V		05-51033975		
	1/2HP, 230V		05-51033976		
	3/4HP, 230V	05-51033978			
1HP, 230V	05-51033979				
RELAY	1-1/2, 2, 3, 5HP	05-55031102			
	5, 7-1/2, 10HP	05-55031601			
ELECTRIC PUMPTEC & PUMPTEC PLUS	PUMPTEC	05-58020116			
	PUMPTEC PLUS	05-58006010			
	QD PUMPTEC	05-58007010			

TITAN INDUSTRIES, INC.
a world of products for the world of water

*Prices are subject to change without notice.
Returns are subject to a restock fee.
Special Orders are non-returnable.*





PRESSURE TANKS & ACCESSORIES

Item	Size	Part No.	List Price	Item	Size	Part No.	List Price
CHALLENGER PRESSURE TANK	14 GAL	07-14PC44000		BRASS FAB TANK TEE	1" x 11"	07-MBAT10000	
	20 GAL	07-20PC66000			1 - 1/2" Drain	07-MBAT125X0	
	26 GAL	07-26PC88000			1-1/4" x 14"	07-MBAT125X2	
	32 GAL	07-32PC11100			1 - 3/4" Drain		
	33 GAL	07-33PC12200		1-1/4" x 16"			
	44 GAL	07-44PC14400		2 - 1/2" Drains			
	62 GAL	07-62PC21100					
	81 GAL	07-81PC24400					
	85 GAL	07-85PC26600					
119 GAL	07-911PC3660						
CHAMPION PRESSURE TANK	20 GAL	07-20CH42020		BRASS CAST TANK TEE 	1" x 11"	07-MBAT100C0	
	32 GAL	07-32CH80030			2 - 1/2" Drains	07-MBAT101C0	
	34 GAL	07-32CH82050			1" x 11"	07-MBAT10250	
	44 GAL	07-44CH10050			1 - 1/2" Drain	07-MBAT125XB	
	62 GAL	07-62CH12051			1-1/4" x 5"		
	86 GAL	07-86CH17002			1 - 3/4" Drain		
	86 GAL TALL	07-86CH17252			1-1/4" Sweat x 3"		
119 GAL	07-911CH2205		1 - 3/4" Drain				
GOULDS PRESSURE TANK IN-LINE MODEL	2 GAL V6P	07-02V06P000		BRASS COMPACT TANK TEE 	1"	07-MBCT10000	
	4.5 GAL V15P	07-04V15P000			1 - 1/2" Drain	07-MBCT12500	
	8.2 GAL V25P	07-04V25P000			1-1/4"		
	14 GAL V45P	07-14V45P000			1 - 3/4" Drain		
GOULDS PRESSURE TANK BURIED MODEL	13.9 GAL	07-V045B000		GALVANIZED TANK TEE 	1" x 3-3/4"	07-MIAT1XB00	
	19.9 GAL	07-V060B000			1 - 1/2" Drain	07-MIAT751XB	
	45.2 GAL	07-V140B000			1" x 3-3/4"	07-MIAT100XB	
	65.1 GAL	07-V200B000			1 - 3/4" Drain	07-MIAT125XB	
TANKS EPOXY COATED W/O TOP-TAPPED	42 GAL	07-EC42S0000		1-1/4" x 4"	07-MIAT7510X		
	42 GAL	07-EC42T0000		1 - 1/2" Drain	07-MIAT75125		
	80 GAL	07-EC8000000		1-1/4" x 3-3/4"			
TANKS EPOXY COATED TOP-TAPPED	42 GAL	07-ERT42S000		1 - 3/4" Drain			
	42 GAL	07-ERT42T000					
	80 GAL	07-ERT800000					
TANKS GALVANIZED	42 GAL SHORT	07-AC3V00000		PRESSURE RELIEF VALVE	1/2"	07-MPRV50000	
AIR VOLUME CONTROL NON-REPAIR	1/4" MIP-AV45	07-MAV450000		3/4"	07-MPRV75000		
	80 Max Tank						
	1/4" MIP-AV45F	07-MAV45F000		AIR VOLUME CONTROL REPAIRABLE	1/4" FIP-AV80	07-MAV800000	
	80 Max Tank				120 Max Tank		
	3/8" MIP-AV100	07-MAV100000					
	120 Max Tank						
3/8" MIP-AV100F	07-MAV100F00						
120 Max Tank							
				BLEEDER ORIFICE 	1" Rubber	07-MB0100000	
					3/4" Brass	07-MBB075000	

TITAN INDUSTRIES, INC.
a world of products for the world of water

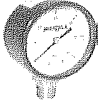
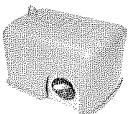
*Prices are subject to change without notice.
Returns are subject to a restock fee.
Special Orders are non-returnable.*

PRESSURE TANKS & ACCESSORIES

Item	Size	Part No.	List Price
STEEL PRESSURE GAUGE 	2" - 0-100 psi	07-MPG100000	
	2" - 0-200 psi	07-MPG200000	
	2" - 0-60 psi	07-MPG600000	
PLASTIC PRESSURE GAUGE	2" - 0-100 psi	07-MPGP100000	
STEEL PRESSURE GAUGE LIQUID FILLED	2-1/2" - 0-100psi	07-MPGL25100	
	2-1/2" - 0-200psi	07-MPGL25200	
PRESSURE SWITCH 	20/40	ELCPRSW20/400	
	30/50	ELCPRSW30/500	
	40/60	ELCPRSW40/600	
	60/80	ELCPRSW60/800	
HEAVY-DUTY PRESSURE SWITCH 	30/50	ELCPRSWH8/100	
	40/60	ELCPRSWHD3/50	
	80/100	ELCPRSWHD4/60	
MANUAL PRESSURE SWITCH 	30/50	ELCPRSWM30/50	
SNIFTER AIR VALVE 	1/8"	07-MSVS12500	
	1/4"	07-MSVS25000	

Prices are subject to change without notice.

Returns are subject to a restock fee.

Special Orders are non-returnable.

TITAN INDUSTRIES, INC.
a world of products for the world of water

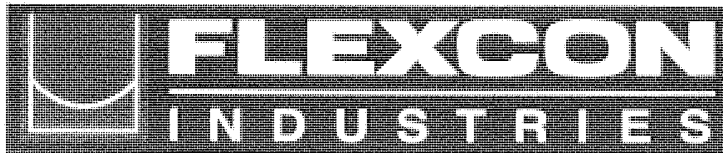

Water Tanks with Quality Features.

5 Year Warranty

All of our quality tanks are backed by a five year written, limited guaranty.

Stainless Steel Water Connection

All of our Online®, Well-Rite® and Challenger® tanks are constructed with a stainless steel water connection that is welded to the tank wall. We believe that this weld provides the strongest water connection in the industry. Our connection is totally lead free, NSF approved for the highest sanitary standard.

Helium Tested

In order to provide the highest quality tanks, we subject our tanks to helium testing and pressure testing to ensure the structural integrity of our tanks.

Controlled Action Diaphragm

Flexcon's patented controlled action, double diaphragm assembly completely contains drawdown water. This design prevents our diaphragm from chafing against the tank wall and surrounds the diaphragm in a pre-pressurized atmosphere.

Tank Replacement Guide

Use the following as a guide to replace existing tanks with a Prepressurized Diaphragm well tank...

Challenger	Well-Rite	H2 Pro	Well-X-Trol	Wel-Flow	Champion	How 2 Tank	Goulds, A.O. Smith	State Perma Tank	Well Mate	Pro-Sputce	Standard Galvanized
PJR6	PJR6	PJR6	WX-101	WF6	CM1001	HT2	V6P	PIL-2	WM8L	N/A	5 GAL.
PJR15	PJR15	PJR15	WX-102	WF15	CM1002	HT4.4	V15P	PIL-5	WM18L	N/A	12 GAL.
PJR20*	PJR20	PJR20	WX-105	N/A	N/A	N/A	N/A	N/A	WM25L	PS15-502	18 GAL.
PJR25*	PJR25	PJR25	WX-103	WF25	CM1003	HT8.6	V25P	PIL-7	N/A	N/A	21 GAL.
PC44	WR45	WWT-14	WX-201	WF45	CM3001	HT14	V45	PAD-14	WM4	PS30-T01	30 GAL.
PC66	WR60	WWT-20	WX-202	WF60	CM4202	HT20	V60	PAD-20	WM6	PS42T-T02	42 GAL.
PC88	WR80	N/A	WX-202XL	N/A	N/A	N/A	V80	N/A	N/A	N/A	82 GAL.
PC111	WR100	WWT-30	WX-205	WF110	CM8205	N/A	N/A	N/A	N/A	PS75T-T03	82 GAL.
PC122	WR120	WWT-35	WX-203	WF100	CM8003	HT32	V100	PAD-36	WM9	PS82T-T05	82 GAL.
PC144	WR140	WWT-45	WX-250	WF140	CM10050	HT44	V140	PAD-52	WM14	PS120-T50	120 GAL.
PC211	WR200	WWT-65	WX-251	WF200	CM12051	HT44	V200	PAD-52	WM20	PS200-T51	220 GAL.
PC244	WR240	WWT-80	WX-255	N/A	N/A	N/A	V250	N/A	N/A	N/A	220 GAL.
PC266	WR260	WWT-85	WX-302	WF260	CM17002	HT86	V260	PAD-86	WM25	PS220-T52	220 GAL.
PC366	WR360	WWT-120	WX-350	WF360	CM22050	HT119	V350	PAD-119	WM35	N/A	315 GAL.

* Add "S" for horizontal models with pump stand.

Controlled Action Diaphragm ("CAD") Operation - 30/50 psi pressure range

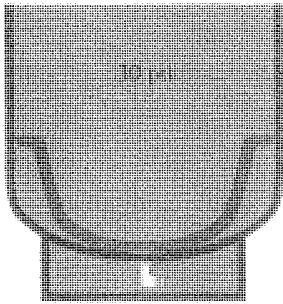

1 Pump comes on and begins to fill Flexcon tank.

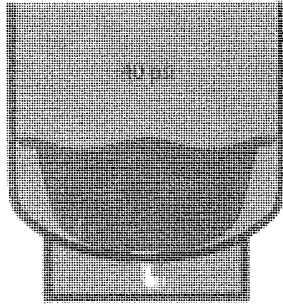

2 Pump continues to run compressing air charge in Flexcon tank.

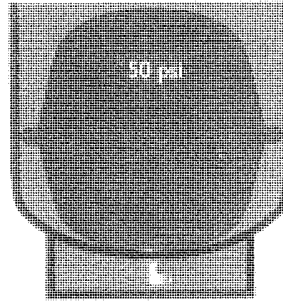

3 Pump shuts off. Drawdown is available on demand.

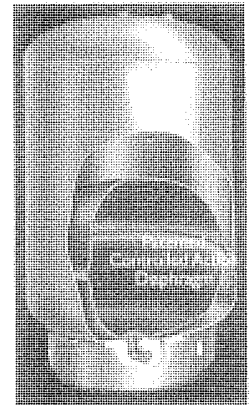

Typical Well Tank Installation

FLEXCON TANK WITH CONVERTIBLE JET PUMP

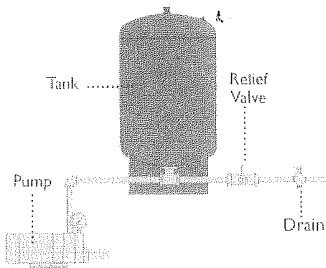

FLEXCON TANK WITH SUBMERSIBLE PUMP

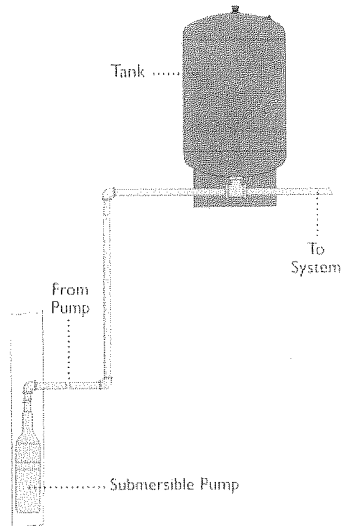

FLEXCON TANK WITH JET PUMP

Mounted On
Optional
Pump Stand

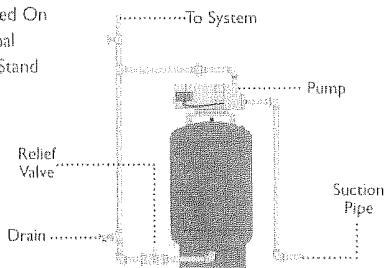

Multi-Tank Installation

FLEXCON MULTI-TANK INSTALLATION - OPTION A

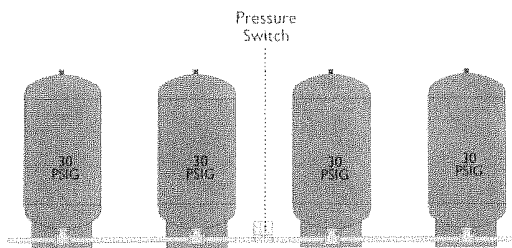

FLEXCON MULTI-TANK INSTALLATION - OPTION B

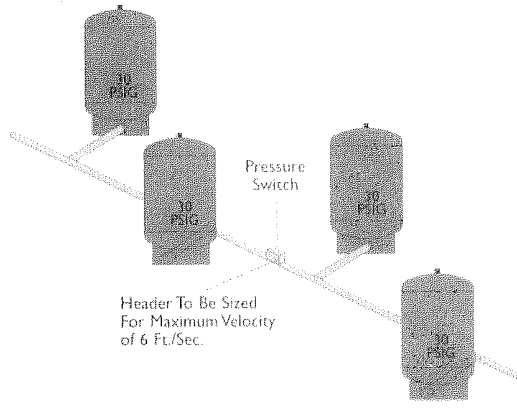

Flexcon Industries
300 Pond Street
Randolph, Massachusetts 02368

For More Information
Call 1.781.986.2424
Fax 1.781.986.2029
www.flexconind.com



NOTES

CALL US TODAY!

PO Box 308
East Hwy 30
Paxton, Nebraska 69155
800-658-4086
308-239-4281
308-239-4474 (fax)

11555 S. Highway 283
Dodge City, Kansas 67801
800-658-4078
620-225-6201
620-225-1171 (fax)

1203 S.E. Grand Blvd.
Oklahoma, City, Oklahoma 73129
800-749-8659
405-677-1290
405-677-1296 (fax)

112 Grant - Aurora Industrial Park
Aurora, Nebraska 68818
800-255-4188
402-694-4188
402-694-4511 (fax)

1912 West Harry
Wichita, Kansas 67213
866-323-9111
316-262-9111
316-262-9119 (fax)

TITAN INDUSTRIES, INC.
a world of products for the world of water

PRESSURE TANK SPECIFICATIONS

CHALLENGER SPECIFICATIONS									
MODEL	DRAWDOWN - GALLONS			TOTAL VOLUME	DIAMETER	HEIGHT	SHIP WEIGHT	SYSTEM	
	20/40	30/50	40/60					CONNECTION	PRECHARGE
PC-44	5.2	4.3	3.8	14.0 GAL	16"	21.7"	29 LB	1"	28 PSI
PC-66	7.4	6.2	5.4	20.0 GAL	16"	28.8"	34 LB	1"	28 PSI
PC-88	9.6	8.1	7	26.0 GAL	16"	36.0"	43 LB	1"	28 PSI
PC-111	11.8	9.9	8.6	32.0 GAL	21"	27.8"	65 LB	1"	28 PSI
PC-122	12.3	10.3	9	33.4 GAL	16"	42.8"	69 LB	1"	28 PSI
PC-144	16.3	13.6	11.9	44.0 GAL	21"	36.2"	71.5 LB	1-1/4"	38 PSI
PC-211	22.9	19.2	16.7	62.0 GAL	21"	47.9"	112 LB	1-1/4"	38 PSI
PC-244	30	25.1	21.9	81.0 GAL	21"	62.0"	103 LB	1-1/4"	38 PSI
PC-266	31.5	26.4	23	85.0 GAL	26"	44.4"	140 LB	1-1/4"	38 PSI
PC-366	43.6	36.8	32.1	119.0 GAL	26"	62.0"	168 LB	1-1/4"	38 PSI

CHAMPION PRECHARGED TANK SPECIFICATIONS									
MODEL	DRAWDOWN - GALLONS			TOTAL VOLUME	DIAMETER	HEIGHT	SHIP WEIGHT	SYSTEM	
	20/40	30/50	40/60					CONNECTION	PRECHARGE
CM1001	0.7	0.6	0.5	2.0 GAL	8"	13"	6 LB	3/4"	28 PSI
CM1002	1.6	1.4	1.2	4.4 GAL	11"	15"	9 LB	3/4"	28 PSI
CM1003	3.1	2.7	2.2	8.6 GAL	11"	25"	14 LB	3/4"	28 PSI
CM3001	5.1	4.3	3.7	14.0 GAL	15"	25"	27 LB	1"	28 PSI
CM4202	7.3	6.2	5.4	20.0 GAL	15"	32"	35 LB	1"	28 PSI
CM8003	11.2	9.9	8.6	32.0 GAL	15"	48"	43 LB	1"	38 PSI
CM8205	12.4	10.5	9.1	34.0 GAL	22"	30"	61 LB	1-1/4"	38 PSI
CM10C50	16.3	13.6	11.9	44.0 GAL	22"	36"	69 LB	1-1/4"	38 PSI
CM12051	22.9	19.2	16.7	62.0 GAL	22"	47"	92 LB	1-1/4"	38 PSI
CM17002	31.8	26.7	23.2	86.0 GAL	26"	47"	123 LB	1-1/4"	38 PSI
CM22050	44	36.9	32.1	119.0 GAL	26"	62"	166 LB	1-1/4"	38 PSI
CM12H	1.9	1.6	1.4	5.3 GAL	10"	19"	15 LB	3/4"	38 PSI
CM40H	5.2	4.3	3.8	14.0 GAL	15"	24"	29 LB	1"	38 PSI
CM202UG	7.4	6.2	5.4	20.0 GAL	15"	30"	33 LB	1"	38 PSI
CM250UG	16.3	13.6	11.9	44.0 GAL	22"	33"	63 LB	1-1/4"	38 PSI

GOULDS IN-LINE MODEL SPECIFICATIONS									
MODEL	DRAWDOWN - GALLONS			TOTAL VOLUME	DIAMETER	HEIGHT	SHIP WEIGHT	SYSTEM	
	20/40	30/50	40/60					CONNECTION	PRECHARGE
V6P	0.7	0.6	0.5	1.2 GAL	8"	11-15/16"	7.5 LB	3/4"	18 PSI
V15P	1.7	1.4	1.2	2.7 GAL	11"	13-15/16"	11.9 LB	3/4"	18 PSI
V25P	3.1	2.6	2.2	4.5 GAL	11"	23-1/16"	21.1 LB	3/4"	28 PSI
V45P	5.1	4.3	3.7	8.4 GAL	15-3/8"	21-1/16"	23.8 LB	1"	28 PSI

GOULDS BURIED MODEL SPECIFICATIONS									
MODEL	DRAWDOWN - GALLONS			TOTAL VOLUME	DIAMETER	HEIGHT	SHIP WEIGHT	SYSTEM	
	20/40	30/50	40/60					CONNECTION	PRECHARGE
V45B	5.1	4.3	3.7	8.4 GAL	15-3/8"	21-1/16"	22.6 LB	1"	28 PSI
V60B	7.3	6.1	5.3	12.1 GAL	15-3/8"	28-1/2"	32.9 LB	1"	28 PSI
V140B	16.5	13.9	12.1	27.3 GAL	22"	32-3/16"	62.3 LB	1-1/4"	38 PSI
V200B	23.9	20	17.4	39.3 GAL	22"	44-1/4"	86.9 LB	1-1/4"	38 PSI

*Prices are subject to change without notice.
Returns are subject to a restock fee.
Special Orders are non-returnable.*

TITAN INDUSTRIES, INC.
a world of products for the world of water

TITAN COMBO TANKS

Item	Size	Part No.	List Price
60 GALLON COMBO TANK PITLESS ADAPTER	4"	07-C46000000	
	5"	07-C56000000	
	6"	07-C66000000	
90 GALLON COMBO TANK PITLESS ADAPTER	4"	07-C49000000	
	5"	07-C59000000	
	6"	07-C69000000	
120 GALLON COMBO TANK PITLESS ADAPTER	4"	07-C41200000	
	5"	07-C51200000	
	6"	07-C61200000	
OPTIONAL ACCESSORY PACK FOR COMBO TANK		07-COPTACCKT (2) 1-1/4"X1" GALV TEE (2) 1" RUBBER BLEEDER ORIFICES (2) 1-1/4" CHECK VALVES	
TOP END FOR COMBO TANK		07-CTOPENDKT (1) 30/50 PRESSURE SWITCH (1) 100PSI PRESSURE GUAGE (1) 1/4" GALV TEE (2) 1/4"XCL GALV NIPPLE	
PVC SCH40 FEMALE ADAPTER (SLIPXFIPT)	4"	21-435040000	
	5"	21-435050000	
	6"	21-435060000	

TITAN COMBO TANK SPECIFICATIONS MAXIMUM WORKING PRESSURE 100 PSI								
MODEL	DRAWDOWN - GALLONS			TOTAL	DIAMETER	HEIGHT	SHIP	DROP PIPE SIZE
	20/40	30/50	40/60					
CT60	18	14	12	60 GAL	30"	27"	300 LB	1-1/4"
CT90	27	21	18	90 GAL	30"	46"	360 LB	1-1/4"
CT120	36	28	23	120 GAL	30"	56"	420 LB	1-1/4"

TITAN INDUSTRIES, INC.
a world of products for the world of water

*Prices are subject to change without notice.
Returns are subject to a restock fee.
Special Orders are non-returnable.*

TITAN COMBO TANK

PROBLEM SOLVING TIPS

If either a waterlogged or airlogged condition exists, remove the well cap and release the seal from the pitless adapter to allow the tank to drain empty, follow the problem solving tips below, restart the system.

CONDITION	POSSIBLE CAUSE	RECOMMENDED SOLUTION
Tank Waterlogged or Airlogged	Improper tank size	Re-evaluate water demand. Has anything changed? For example, were there formerly two houses and now just one? If watering livestock, is there now a larger or smaller herd? In some cases, based upon a significant change, it may be necessary to put in a larger or smaller size tank
	Plugged Bleeder Valves (sand or other debris)	Inspect, clean and/or replace as required
	Bleeder Valves installed improperly	There must be spacing of at least 18' to 20' between Bleeder Valves. (Refer to our Installation Instructions). In shallow water applications it is suggested to go to a larger pipe size, preferable 2" or larger. This allows the tank to receive the proper air charge volume. An alternative is to use a submersible pump shell (canister). This canister consists of the shell of a used submersible pump, with a recommended length of approx. 15" to 18". Screw the discharge head of two used pump heads onto the canister and put this new "air chamber" into the drop pipe right below the check valve (see point 3-5 of installation guidelines). This will allow additional air volume charge
	Improper alignment of float head	The pressure switch location must be set at 180° from float head. This will give proper room for float movement.
	Improper seal around float head, fitting from float head, pressure switch gauge, ect.	It is a must on every installation that you check for any air seepage around these fittings. Since the proper sealant has been supplied - please use it!
	Cross threaded fittings in the float head	Depends upon the extent of damage to the threads, repair and/or replace threads as required.
	Improperly wired pump	Apply standard suggested wiring guidelines as set forth by the motor and/or control manufacturer.
	Improper alignment of Pitless Unit in Tank	Pull and inspect the "O" Ring of the Pitless Unit. Replace the o-ring if excessively worn. Align the pitless unit per the installation instructions.
	Improper seal on check valve	Pull, inspect and replace as necessary.
	Moisture in the diaphragm of the pressure switch freezes which can prevent the pressure switch to open or close. The result is that the points on the switch are on or off and the pump continues to run, ultimately filling the tank completely with water or allowing compressed air to escape.	We recommend a water tight pressure switch be installed along with water tight conduit connectors. To provide additional security from the weather, vandalism, or from other disturbance such as insects or animals, a light wall steel or PVC pipe can be used to encase these components.
	Water leak in drop pipe to the pump.	Repair and/or replace defective pipe.
System Restarting Instructions	Turn on power to pump. Check and soap all joints on the float head. Install water tight well cap by slipping lower flange over bury pipe, installing o-ring gasket and securing upper portion of the cap with the threaded bolts provided. To achieve tank balance, the quickest method is to plug the bleed hole and pre-charge the tank to 7 to 8 psi. Note: You can read this on the gauge. Leave the hole plugged until the pump shuts off the first time. Then remove the plug.	

TITAN INDUSTRIES, INC.
a world of products for the world of water

Prices are subject to change without notice.

Returns are subject to a restock fee.

Special Orders are non-returnable.

H2OPTIMAL PITLESS CONTROL MODULE

Item	Size	Part No.	List Price
PITLESS CONTROL MODULE	2.2 GAL TANK 1-1/4" DISCHARGE 4" X 5' BURY 5" X 5' BURY 6" X 5' BURY	07-H20PCM452 07-H20PCM552 07-H20PCM652	
	4.5 GAL TANK 1-1/4" DISCHARGE 4" X 5' BURY 5" X 5' BURY 6" X 5' BURY	07-H20PCM454 07-H20PCM554 07-H20PCM654	
	ADD OR SUBTRACT BURY DEPTH ADD FOR 2" DISCHARGE		
PIT CONTROL MODULE KIT	W/2 GAL TANK	07-H20CMK2XL	
	W/4.5 GAL TANK	07-H20CMK4XL	
INCLUDES ONLY INTERNAL COMPONENTS AND LID.			
VARIABLE SPEED DRIVE	SINGLE OR THREE PHASE INPUT 1/2 HP 208/230V 1 HP 208/230V 1-1/2 HP 208/230V 2 HP 208/230V 3 HP 208/230V 5 HP 208/230V	07-H20SF205Y 07-H20SF210Y 07-H20SF215Y 07-H20SF220Y 07-H20SF230Y 07-H20SF250Y	
	THREE PHASE INPUT ONLY 1 HP 208/230V 1-1/2 HP 208/230V 2 HP 208/230V 3 HP 208/230V 5 HP 208/230V 7.5 HP 208/230V 10 HP 208/230V 15 HP 208/230V 20 HP 208/230V	07-H20SF2010 07-H20SF2015 07-H20SF2020 07-H20SF2030 07-H20SF2050 07-H20SF2075 07-H20SF2100 07-H20SF2150 07-H20SF2200	
	THREE PHASE INPUT ONLY 1/2 HP 400/480V 1 HP 400/480V 1-1/2 HP 400/480V 2 HP 400/480V 3 HP 400/480V 5 HP 400/480V 7.5 HP 400/480V 10 HP 400/480V 15 HP 400/480V 20 HP 400/480V 25 HP 400/480V	07-H20SF4005 07-H20SF4010 07-H20SF4015 07-H20SF4020 07-H20SF4030 07-H20SF4050 07-H20SF4075 07-H20SF4100 07-H20SF4150 07-H20SF4200 07-H20SF4250	
PRESSURE TRANSDUCER	0-100 psi, 4-20mA Pressure Transducer w/ 1/4" male connection and 2 meter (6 foot) lead	07-H20PD0100	

TITAN INDUSTRIES, INC.

a world of products for the world of water

Prices are subject to change without notice.

Returns are subject to a restock fee.

Special Orders are non-returnable.

Advantages of the H₂Optimal Pitless Control Module *Patent Pending*

Easy to install, reduces labor costs.

Eliminates confined space entry concerns.

Compatible with most submersible pumps.

Provides constant pressure to the water system.

The module can eliminate the need for pressure tanks.

High capacity systems are less expensive and easier to install.

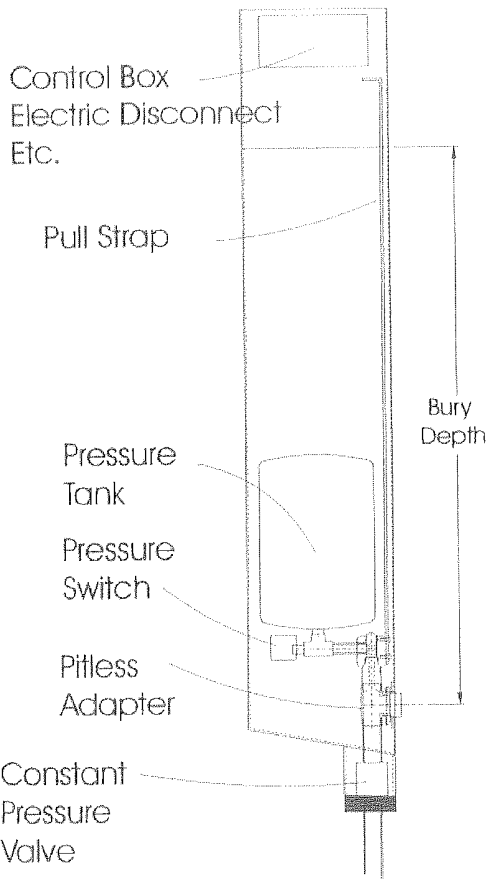

PCM for Constant Speed Pump

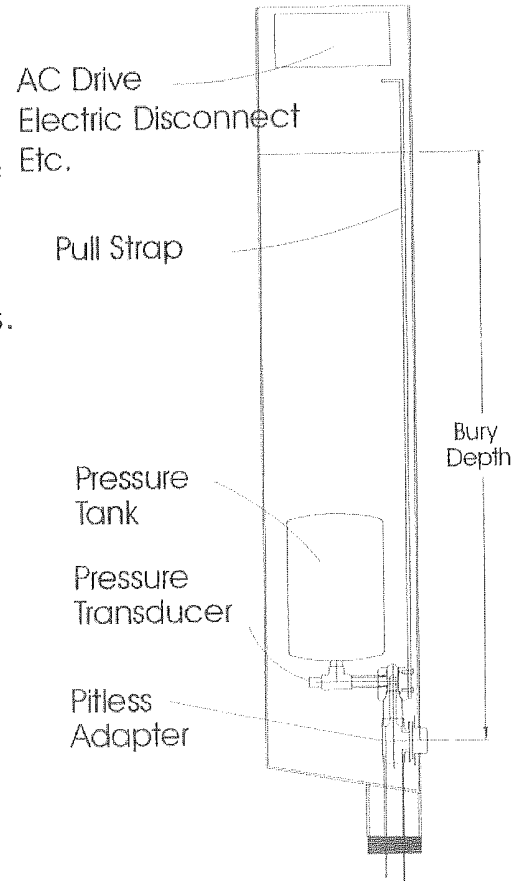

PCM for Variable Speed Pump

H₂Optimal, Inc.
Ithaca, NE
www.pitlessunit.com

Pump controls mount on underside of lid.



Distributor

Nearly vandal proof!
 This is all you see above ground.

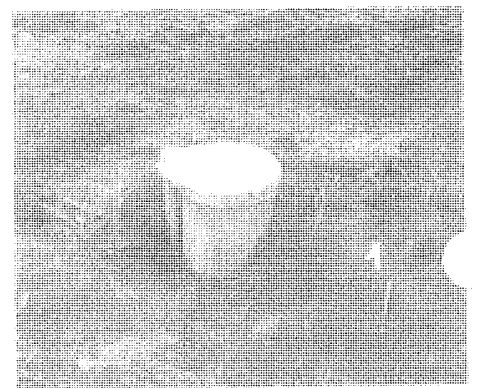

HYDRANTS & ACCESSORIES

Item	Size	Part No.	List Price	Item	Size	Part No.	List Price
STANDARD ANYFLOW	3/4" X 1'	46-AF7501000		PARTS FOR 3/4" ANFLOW			
	3/4" X 2'	46-AF7502000		HEAD CASTING		46-G1HC00000	
	3/4" X 3'	46-AF7503000		HOSE ADAPTER		46-G5HA00000	
	3/4" X 4'	46-AF7504000		LEVER CASTING		46-G11LC0000	
	3/4" X 5'	46-AF7505000		LEVER BOLT & NUT		46-G15LB0000	
	3/4" X 6'	46-AF7506000		VALVE BODY		46-G40VB0000	
	3/4" X 7'	46-AF7507000		BRASS BUSHING		46-G65BB0000	
	3/4" X 8'	46-AF7508000		PLUNGER BODY		46-G70PB0000	
	3/4" X 10'	46-AF7509000		PLUNGER BOLT		46-G75PB0000	
HI-CAPACITY ANYFLOW	1" X 1'	46-AF1010000		BRASS WASHER		46-G80BW0000	
	1" X 2'	46-AF1020000		3/8"BIBB WASHER		46-G85BW0000	
	1" X 3'	46-AF1030000		RETAIN SCREW		46-G100RS000	
	1" X 4'	46-AF1040000		CUP LEATHER PR		46-G105CL000	
	1" X 5'	46-AF1050000		BRASS WASHER PR		46-G110BW000	
	1" X 6'	46-AF1060000		PLUNGER ASSEMBLY		46-G115PA000	
	1" X 7'	46-AF1070000		HEAD ASSEMBLY		46-G120HA000	
	1" X 8'	46-AF1080000		PARTS FOR 1" ANYFLOW			
	1" X 10'	46-AF1100000		HEAD CASTING		46-G2HC00000	
C-1000 HYDRANT	3/4" X 1'	46-C75010000		HOSE ADAPTER		46-G6HA00000	
	3/4" X 1-1/2'	46-C75015000		LEVER CASTING		46-G10LC0000	
	3/4" X 2'	46-C75020000		DRAW STRAP PR		46-G20DS0000	
	3/4" X 3'	46-C75030000		PIVOT CON/NUT		46-G25PC0000	
	3/4" X 4'	46-C75040000		PACKING NUT		46-G30PN0000	
	3/4" X 5'	46-C75050000		PACKING		46-G35P00000	
	3/4" X 6'	46-C75060000		VALVE BODY		46-G41VB0000	
	3/4" X 7'	46-C75070000		STAINLESS STEEL ROD		46-G45SR0000	
	3/4" X 8'	46-C75080000		BRASS REDUCER		46-G50BR0000	
3/4" X 10'	46-C75100000		BRASS WASHER		46-G81BW0000		
HYDRANT Y1 & Y2	3/4" X 1' Y1	46-Y17501000		3/8"BIBB WASHER		46-G86BW0000	
	3/4" X 2' Y1	46-Y17502000		STAINLESS STEEL SPRING		46-G90SS0000	
	3/4" X 3' Y1	46-Y17503000		CUP LEATHER PR		46-G106CL000	
	3/4" X 4' Y1	46-Y17504000		BRASS WASHER PR		46-G111BW000	
	3/4" X 5' Y1	46-Y17505000		PLUNGER ASSEMBLY		46-G116PA000	
	3/4" X 2' Y2	46-Y27502000		HEAD ASSEMBLY		46-G121HA000	
	3/4" X 3' Y2	46-Y27503000		PARTS KIT			
	3/4" X 4' Y2	46-Y27504000		ANYFLOW(PKA)		46-PKA000000	
	3/4" X 5' Y2	46-Y27505000		ANYFLOW(PKAF)		46-PKAF00000	
HYDRANT ELBOW	3/4"	46-RBHE75000		C-1000(PKC)		46-PKC000000	
	1"	46-RBHE10000		C-1000(PKCF)		46-PKCF00000	
	1" X 3/4"	46-RBHE10000		PARTS FOR C-1000 HYDRANT			
	1-1/4"	46-RBHE12500		HEAD CASTING		46-A1HC00000	
	1" X L	46-RBHEL1000		LEVER CASTING		46-P11LC0000	
	1" X L X 3/4"	46-RBHEL1000		LEVER BOLT & NUT		46-P15LB0000	
HYDRANT TEE	1"	46-RBHT10000		VALVE BODY		46-A40VB0000	
	3/4" BRASS	46-RBHT75000		ROD REDUCER		46-P50RR0000	
	1" X 3/4"	46-RBHT75100		PLUNGER		46-A115P0000	
				SILICON LUBE		46-A250SL000	
				HEAD ASSY		46-A121HA000	

TITAN INDUSTRIES, INC.
a world of products for the world of water

*Prices are subject to change without notice.
Returns are subject to a restock fee.
Special Orders are non-returnable.*

PITLESS UNITS & WELL SEALS

Item	Size	Part No.	List Price	Item	Size	Part No.	List Price	
MERRILL SP PITLESS UNIT WITH WATERTIGHT CAP	4" X 3' WC	47-SP403WC00		SNAP-ON PITLESS ADAPTER	AG 5" X 1-1/4"	47-SP501WC00		
	4" X 4' WC	47-SP404WC00			REORDER # BA5-125			
	4" X 5' WC	47-SP405WC00		MAASS MODEL J WELD-ON PITLESS ADAPTER	4-5" X 1-1/4"	47-929105000		
	4" X 6' WC	47-SP406WC00			6-7-8" X 1"	47-928120000		
	5" X 3' WC14	47-SP503WC14			6-7-8" X 1-1/4"	47-928125000		
	5" X 4' WC14	47-SP504WC14			6-7-8" X 2"	47-928135000		
	5" X 5' WC14	47-SP505WC14			8-10-12" X 3"	47-928145000		
	5" X 6' WC14	47-SP506WC14			10-12-14" X4"	47-928150000		
	5" X 3' WC2	47-SP503WC20			CAST IRON WELL SEAL SINGLE DROP PIPE SPLIT TOP PLATE	AG 3" X 1"	47-WSC030010	
	5" X 4' WC2	47-SP504WC20				AG 3" X 1-1/4"	47-WSC030012	
	5" X 5' WC2	47-SP505WC20				4" X 1"	47-WSC040010	
	5" X 6' WC2	47-SP506WC20				4" X 1-1/4"	47-WSC040012	
	6" X 3' WC	47-SP603WC00		4" X 1-1/2"		47-WSC040015		
	6" X 4' WC	47-SP604WC00		4" X 2"		47-WSC040020		
	6" X 5' WC	47-SP605WC00		4-1/2" X 1"		47-WSC045010		
6" X 6' WC	47-SP606WC00		4-1/2" X 1-1/4"	47-WSC045012				
8" X 3' WC	47-SP803WC00		5" X 1"	47-WSC050010				
8" X 4' WC	47-SP804WC00		5" X 1-1/4"	47-WSC050012				
8" X 5' WC	47-SP805WC00		5" X 1-1/2"	47-WSC050015				
8" X 6' WC	47-SP806WC00		5" X 2"	47-WSC050020				
MERRILL SP PITLESS COMPLETE INSIDE ASSEMBLIES	4" X 4' CIA	47-SP404CIA0		6" X 1"	47-WSC060010			
	4" X 5' CIA	47-SP405CIA0		6" X 1-1/4"	47-WSC060012			
	4" X 6' CIA	47-SP406CIA0		6" X 2"	47-WSC060020			
	5" X 4' CIA	47-SP504CIA0		6" X 3"	47-WSC060030			
	5" X 5' CIA	47-SP505CIA0		AG 6-5/8"X1-1/4"	47-WSC066125			
	5" X 6' CIA	47-SP506CIA0		AG 6-5/8" X 2"	47-WSC066020			
	6" X 3' CIA	47-SP603CIA0		8" X 1"	47-WSC080010			
	6" X 4' CIA	47-SP604CIA0		8" X 1-1/2"	47-WSC080015			
	6" X 5' CIA	47-SP605CIA0		8" X 2"	47-WSC080020			
6" X 6' CIA	47-SP606CIA0		8" X 3"	47-WSC080030				
MERRILL SPK PITLESS KIT	4" X 4'	47-SPK404WC0		8" X 4"	47-WSC080040			
	5" X 3'	47-SPK503WC0		10" X 2"	47-WSC100020			
	5" X 4'	47-SPK504WC0		10" X 3"	47-WSC100030			
MERRILL WATERTIGHT CAP	4"	47-WC4000000		10" X 4"	47-WSC100040			
	5"	47-WC5000000		10" X 5"	47-WSC100050			
	6"	47-WC6000000		12" X 3"	47-WSC120030			
	8"	47-WC8000000		12" X 4"	47-WSC120040			
MERRILL PITLESS CONNECTOR	4"	47-ZAPC40000		12" X 5"	47-WSC120050			
	5"	47-ZAPC50000		12" X 6"	47-WSC120060			
	6"	47-ZAPC60000		CAST IRON WELL SEAL DOUBLE DROP PIPE SPLIT TOP PLATE	4"X1-1/4"X1"	47-WSC041201		
MINI PITLESS ADAPTER	1" DOMESTIC	47-ZMB600000			4-1/2"X1-1/4"X1"	47-WSC045121		
	1" DOMESTIC	47-ZMB100000			5" X 1-1/4" X 1"	47-WSC051210		
	1" IMPORT	47-ZMB200000			5"X1-1/4"X1-1/4"	47-WSC051212		
	1-1/4" IMPORT	47-ZMB225000			6" X 1-1/4" X 1"	47-WSC061210		
	2" IMPORT	47-ZMHB30000			6"X1-1/4"X1-1/4"	47-WSC061212		
	1-1/4"X1"DOMEST	47-ZMHB40000			6"X1-1/2"X1-1/2"	47-WSC061515		
	1" FOR 6" PIPE	47-ZOPS56S4C		CALL FOR PRICING ON BAKER - MAASS MIDWEST PITLESS UNITS.				

TITAN INDUSTRIES, INC.
a world of products for the world of water

*Prices are subject to change without notice.
Returns are subject to a restock fee.
Special Orders are non-returnable.*

PITLESS UNITS & WELL SEALS

Item	Size	Part No.	List Price	Item	Size	Part No.	List Price
MERRILL PLASTIC WELL SEAL SINGLE DROP PIPE	2" X 1"	47-WSP020010		1" PITLASS ADAPTER	FOR OAWS AT	47-ATWPA0100	
	4" X 1"	47-WSP040010			THE WELL CONTROL		
	4" X 1-1/4"	47-WSP040012		4" AT THE WELL CONTROL 47-ATWC04000			
	4" X 1-1/2"	47-WSP040015		LIFT-OUT 4'			
	4" X 2"	47-WSP040020		ROD FOR 5'			
	4-1/2" X 1"	47-WSP045010		OAWS 6'			
	5" X 1"	47-WSP050010		3/8" x 1/4" 12-230302HEX			
	5" X 1-1/4"	47-WSP050012		TURTLE CAP 5"			
	5" X 1-1/2"	47-WSP050015		6"			
	5" X 2"	47-WSP050020		6" W/PVC RING 47-50WE10000			
	5-1/2" X 1"	47-WSP055010		47-60WE10000			
	6" X 1"	47-WSP060010		47-6PT100000			
	6" X 1-1/4"	47-WSP060012					
	6" X 2"	47-WSP060020					
	6-1/4" X 1"	47-WSP062010					
	6-1/2" X 1"	47-WSP065010					
	6-1/2" X 1-1/4"	47-WSP065012					
	8" X 1"	47-WSP080010					
	8" X 1-1/4"	47-WSP080012					
	8" X 2"	47-WSP080020					
MERRILL PLASTIC WELL SEAL DOUBLE DROP PIPE	4-1/2"X1-1/4"X1"	47-WSP045012					
	5" X 1-1/4" X 1"	47-WSP051012					
	5-1/2"X1-1/4"X1"	47-WSP551210					
	6" X 1" X 1-1/4"	47-WSP061012					
	6-1/4"X1-1/4"X1"	47-WSP621210					
6-1/2"X1"X1-1/4"	47-WSP651012						

TITAN INDUSTRIES, INC.
a world of products for the world of water

*Prices are subject to change without notice.
Returns are subject to a restock fee.
Special Orders are non-returnable.*

BRASS, PVC AND CAST IRON VALVES

Item	Size	Part No.	List Price	Item	Size	Part No.	List Price
FLOMATIC ENVIRO- CHECK	1/2" 80E	48-FCV4029E0		AG 6300 BRONZE CHECK VALVE	3/4"	48-6300075AG	
	3/4" 80E	48-FCV4030E0			1"	48-6300100AG	
	1" 80E	48-FCV4031E0			1-1/4"	48-6300120AG	
	1-1/4" 80E	48-FCV4032E0			1-1/2"	48-6300150AG	
	1-1/2" 80E	48-FCV4033E0			2"	48-6300200AG	
	2" 80E	48-FCV4034E0					
	2-1/2" 80E	48-FCV4035E0		AG 5300 BRONZE CHECK VALVE	1/2"	48-5300050AG	
	3" 80E	48-FCV4036E0		2-1/2"	48-5300250AG		
	4" 80E	48-FCV4037E0		3"	48-5300300AG		
				4"	48-5300400AG		
FLOMATIC TAPPED CHECK 1/8" & 1/4"	3/4" 80BE 1" 80BE 1-1/4" 80BE 1-1/2" 80BE	48-FCC4050E0 48-FCC4051E0 48-FCC4052E0 48-FCC4053E0		MERRILL 600 SERIES CHECK VALVE	1/2"	48-CVR500000	
FLOMATIC TAPPED CHECK 1/4" & 1/4"	1" 80XBE	48-FCC7961E0			3/4"	48-CVR750000	
	1-1/4" 80XBE	48-FCC7963E0			1"	48-CVR100000	
	1-1/2" 80XBE	48-FCC7964E0			1-1/4"	48-CVR125000	
	2" 80XBE	48-FCC7965E0			1-1/2"	48-CVR150000	
				2"	48-CVR200000		
				3"	48-CVR300000		
FLOMATIC TAPPED CHECK	1" 80CE 1-1/4" 80CE 1-1/2" 80CE	48-FCC4061E0 48-FCC4062E0 48-FCC4063E0		MERRILL 800 SERIES CHECK VALVE NO-SPIN POPPET	1/2"	48-CV5000000	
FLOMATIC 80ME	1" M X 1" F	48-FPC4071E0			3/4"	48-CV7500000	
	2" M X 2" F	48-FPC4079E0			1"	48-CV1000000	
					1-1/4"	48-CV1250000	
					1-1/2"	48-CV1500000	
				2"	48-CV2000000		
				3"	48-CV3000000		
				4"	48-CV4000000		
FLOMATIC 100ME PUMP CHECK	1-1/4"M X 1"F 1-1/4"M X 1"F 1-1/4"M X F 1-1/4"M1-1/2"F	48-FPC4221E0 48-FPC4221LE 48-FPC4242E0 48-FPC4223E0		MISC PUMP CHECKS MIPT X FIPT	1-1/4" M 1" F	48-630204010	
					1-1/4" M 1" F	48-CVM125000	
					1-1/4"	48-CVM125200	
					1-1/4"	48-FPBC15410	
FLOMATIC STAINLESS STEEL PUMP CHECK				FLOMATIC 80MDI MIPT X FIPT	4"	48-FCV407700	
	1-1/4"MX1"F100MSS	48-FPC4221SS			6"	48-FCV408100	
					8" X 6"	48-FCV406800	
FLOMATIC MODEL 80DI DUCTILE CHECK	3"	48-FCV793800		GOULDS DUCTILE IRON CHECK VALVE	4"	48-C03105B08	
	4"	48-FCV793900			6"	48-C03105B12	
	5"	48-FCV408800			8"	48-C03105B16	
	6"	48-FCV408900					
	8"	48-FCV409000					
80DIX	10"	48-FCV4091DX		TECHNO- CHECK VALVE	3" MIPT	48-TECH35020	
FLOMATIC 80DI WITH BREAK-OFF PLUG	3"	48-FCV7938PL			4" MIPT	48-TECH4502F	
	4"	48-FCV7939PL			5" MIPT	48-TECH502A0	
	5"	48-FCV4088PL			6" MIPT	48-TECH60000	
	6"	48-FCV4089PL					
	8"	48-FCV4090PL		TECHNO- CHECK WITH BREAK OFF PLUG	3" FIPT	48-TECH3502B	
					4" FIPT	48-TECH4502B	
					5" FIPT	48-TECH502FB	
					6" FIPT	48-TECH6000B	
FLOMATIC 80DICL CERTAINTTEED CERTA-LOK ENDS	2"	48-FCV7937CL		BREAKOFF PLUG	3"	48-FBOP76096	
	3"	48-FCV7938CL			4"	48-FBOP76097	
	4"	48-FCV7939CL			5" - 6" - 8"	48-FBOP76098	
	5"	48-FCV408800					
	6"	48-FCV4089CL					

Prices are subject to change without notice.

Returns are subject to a restock fee.

Special Orders are non-returnable.

TITAN INDUSTRIES, INC.
a world of products for the world of water

BRASS, PVC AND CAST IRON VALVES

Item	Size	Part No.	List Price	Item	Size	Part No.	List Price																																																								
6340	3/4"	48-6340007FV		AG MODEL	1"	48-630010200																																																									
AG BRASS	1"	48-6430010FV		6300 CHECK	1-1/4"	48-630012200																																																									
FOOT VALVE	1-1/4"	48-6340012FV		TAPPED	1-1/2"	48-630015200																																																									
PVC	1-1/2"	48-6340015FV		1/8" & 1/4"	2"	48-630020200																																																									
SCREEN	2"	48-6340020FV																																																													
				<table border="1" style="width: 100%; border-collapse: collapse;"> <tr><td>BRASS</td><td>1/4"</td><td>48-BGV940130</td><td></td></tr> <tr><td>THREADED</td><td>3/8"</td><td>48-BGV940131</td><td></td></tr> <tr><td>GATE</td><td>1/2"</td><td>48-BGV940132</td><td></td></tr> <tr><td>VALVE</td><td>3/4"</td><td>48-BGV940133</td><td></td></tr> <tr><td></td><td>1"</td><td>48-BGV940134</td><td></td></tr> <tr><td></td><td>1-1/4"</td><td>48-BGV940135</td><td></td></tr> <tr><td></td><td>1-1/2"</td><td>48-BGV940136</td><td></td></tr> <tr><td></td><td>2"</td><td>48-BGV940137</td><td></td></tr> <tr><td></td><td>2-1/2"</td><td>48-BGV940138</td><td></td></tr> <tr><td></td><td>3"</td><td>48-BGV940139</td><td></td></tr> <tr><td></td><td>4"</td><td>48-BGV940140</td><td></td></tr> </table>				BRASS	1/4"	48-BGV940130		THREADED	3/8"	48-BGV940131		GATE	1/2"	48-BGV940132		VALVE	3/4"	48-BGV940133			1"	48-BGV940134			1-1/4"	48-BGV940135			1-1/2"	48-BGV940136			2"	48-BGV940137			2-1/2"	48-BGV940138			3"	48-BGV940139			4"	48-BGV940140													
BRASS	1/4"	48-BGV940130																																																													
THREADED	3/8"	48-BGV940131																																																													
GATE	1/2"	48-BGV940132																																																													
VALVE	3/4"	48-BGV940133																																																													
	1"	48-BGV940134																																																													
	1-1/4"	48-BGV940135																																																													
	1-1/2"	48-BGV940136																																																													
	2"	48-BGV940137																																																													
	2-1/2"	48-BGV940138																																																													
	3"	48-BGV940139																																																													
	4"	48-BGV940140																																																													
MERRILL	1/2"	48-610FVR005																																																													
610	3/4"	48-610FVR007																																																													
BRASS	1"	48-610FVR100																																																													
FOOT VALVE	1-1/4"	48-610FVR125																																																													
STAINLESS	1-1/2"	48-610FVR150																																																													
SCREEN	2"	48-610FVR200																																																													
				<table border="1" style="width: 100%; border-collapse: collapse;"> <tr><td>GLOBE</td><td>1"</td><td>48-BGV940304</td><td></td></tr> <tr><td>VALVE</td><td>1-1/4"</td><td>48-BGV940305</td><td></td></tr> </table>				GLOBE	1"	48-BGV940304		VALVE	1-1/4"	48-BGV940305																																																	
GLOBE	1"	48-BGV940304																																																													
VALVE	1-1/4"	48-BGV940305																																																													
FLOMATIC	1/2"	48-60SE005FV																																																													
60SE	3/4"	48-60SE007FV																																																													
STAINLESS	1"	48-60SE010FV																																																													
SCREEN	1-1/4"	48-60SE102FV																																																													
FOOT VALVE	1-1/2"	48-60SE015FV																																																													
	2"	48-60SE020FV																																																													
				<table border="1" style="width: 100%; border-collapse: collapse;"> <tr><td>THREADED</td><td>1/4"</td><td>48-HFBVT6025</td><td></td></tr> <tr><td>BALL</td><td>3/8"</td><td>48-HFBVT6038</td><td></td></tr> <tr><td>VALVES</td><td>1/2"</td><td>48-HFBVT6050</td><td></td></tr> <tr><td></td><td>3/4"</td><td>48-HFBVT6075</td><td></td></tr> <tr><td></td><td>1"</td><td>48-HFBVT6100</td><td></td></tr> <tr><td></td><td>1-1/4"</td><td>48-HFBVT6125</td><td></td></tr> <tr><td></td><td>1-1/2"</td><td>48-HFBVT6150</td><td></td></tr> <tr><td></td><td>2"</td><td>48-HFBVT6200</td><td></td></tr> <tr><td></td><td>2-1/2"</td><td>48-HFBVT6250</td><td></td></tr> <tr><td></td><td>3"</td><td>48-HFBVT6300</td><td></td></tr> <tr><td></td><td>4"</td><td>48-HFBVT6400</td><td></td></tr> <tr><td></td><td>1/2" GAS</td><td>48-HGBVL050T</td><td></td></tr> <tr><td></td><td>3/4" GAS</td><td>48-HGBVL075T</td><td></td></tr> <tr><td></td><td>1" GAS</td><td>48-HGBVL100T</td><td></td></tr> </table>				THREADED	1/4"	48-HFBVT6025		BALL	3/8"	48-HFBVT6038		VALVES	1/2"	48-HFBVT6050			3/4"	48-HFBVT6075			1"	48-HFBVT6100			1-1/4"	48-HFBVT6125			1-1/2"	48-HFBVT6150			2"	48-HFBVT6200			2-1/2"	48-HFBVT6250			3"	48-HFBVT6300			4"	48-HFBVT6400			1/2" GAS	48-HGBVL050T			3/4" GAS	48-HGBVL075T			1" GAS	48-HGBVL100T	
THREADED	1/4"	48-HFBVT6025																																																													
BALL	3/8"	48-HFBVT6038																																																													
VALVES	1/2"	48-HFBVT6050																																																													
	3/4"	48-HFBVT6075																																																													
	1"	48-HFBVT6100																																																													
	1-1/4"	48-HFBVT6125																																																													
	1-1/2"	48-HFBVT6150																																																													
	2"	48-HFBVT6200																																																													
	2-1/2"	48-HFBVT6250																																																													
	3"	48-HFBVT6300																																																													
	4"	48-HFBVT6400																																																													
	1/2" GAS	48-HGBVL050T																																																													
	3/4" GAS	48-HGBVL075T																																																													
	1" GAS	48-HGBVL100T																																																													
333E	1"	48-333010000																																																													
FOOT VALVE	1-1/4"	48-333012000																																																													
				<table border="1" style="width: 100%; border-collapse: collapse;"> <tr><td>BRASS</td><td>1/2"</td><td>48-HFBVS6050</td><td></td></tr> <tr><td>SWEAT</td><td>3/4"</td><td>48-HFBVS6075</td><td></td></tr> <tr><td>BALL</td><td>1"</td><td>48-HFBVS6100</td><td></td></tr> <tr><td>VALVES</td><td>1-1/4"</td><td>48-HFBVS6125</td><td></td></tr> <tr><td></td><td>1-1/2"</td><td>48-HFBVS6150</td><td></td></tr> <tr><td></td><td>2"</td><td>48-HFBVS6200</td><td></td></tr> </table>				BRASS	1/2"	48-HFBVS6050		SWEAT	3/4"	48-HFBVS6075		BALL	1"	48-HFBVS6100		VALVES	1-1/4"	48-HFBVS6125			1-1/2"	48-HFBVS6150			2"	48-HFBVS6200																																	
BRASS	1/2"	48-HFBVS6050																																																													
SWEAT	3/4"	48-HFBVS6075																																																													
BALL	1"	48-HFBVS6100																																																													
VALVES	1-1/4"	48-HFBVS6125																																																													
	1-1/2"	48-HFBVS6150																																																													
	2"	48-HFBVS6200																																																													
333 DPE	1-1/4" M X 1" F	48-333DPE012																																																													
FOOT VALVE	1-1/2" M X 1-1/4" F	48-333DPE015																																																													
AG 5400	3"	48-5400030FV																																																													
CAST IRON	4"	48-5400040FV																																																													
FOOT VALVE	6"	48-5400060FV																																																													
				<table border="1" style="width: 100%; border-collapse: collapse;"> <tr><td>FROST</td><td>1/2" X 4"</td><td>48-H50400000</td><td></td></tr> <tr><td>PROOF</td><td>1/2" X 6"</td><td>48-H50600000</td><td></td></tr> <tr><td>SILL COCKS</td><td>1/2" X 8"</td><td>48-H50800000</td><td></td></tr> <tr><td></td><td>1/2" X 10"</td><td>48-H51000000</td><td></td></tr> <tr><td></td><td>1/2" X 12"</td><td>48-H51200000</td><td></td></tr> <tr><td></td><td>1/2" X 14"</td><td>48-H51400000</td><td></td></tr> </table>				FROST	1/2" X 4"	48-H50400000		PROOF	1/2" X 6"	48-H50600000		SILL COCKS	1/2" X 8"	48-H50800000			1/2" X 10"	48-H51000000			1/2" X 12"	48-H51200000			1/2" X 14"	48-H51400000																																	
FROST	1/2" X 4"	48-H50400000																																																													
PROOF	1/2" X 6"	48-H50600000																																																													
SILL COCKS	1/2" X 8"	48-H50800000																																																													
	1/2" X 10"	48-H51000000																																																													
	1/2" X 12"	48-H51200000																																																													
	1/2" X 14"	48-H51400000																																																													
BOSHART	2" PVC	48-17PFV2000																																																													
PVC FOOT	3" PVC	48-17PFV3000																																																													
VALVES																																																															
BRADY	1"	48-BRS0100FV																																																													
PLASTIC	1-1/4"	48-BRS0125FV																																																													
FOOT VALVE	1-1/2"	48-BRS0150FV																																																													
				<table border="1" style="width: 100%; border-collapse: collapse;"> <tr><td>VACCUUM</td><td>3/4"</td><td>48-HBVV75P00</td><td></td></tr> <tr><td>BREAKER</td><td>3/4" CHROME</td><td>48-BVB75P000</td><td></td></tr> </table>				VACCUUM	3/4"	48-HBVV75P00		BREAKER	3/4" CHROME	48-BVB75P000																																																	
VACCUUM	3/4"	48-HBVV75P00																																																													
BREAKER	3/4" CHROME	48-BVB75P000																																																													
PVC	1-1/4" COMP	48-Z15001200																																																													
SWING	2" IPS COMP	48-ZA92P0000																																																													
CHECK	3" IPS COMP	48-Z15003000																																																													
VALVE	4" IPS S X S	48-Z15204000																																																													
PVC CHECK	1-1/2" IPS S X S	48-Z10121500																																																													
VALVES	2" IPS F X F	48-Z10012000																																																													
				<table border="1" style="width: 100%; border-collapse: collapse;"> <tr><td>BRASS</td><td>1/2"</td><td>48-HSCV050TS</td><td></td></tr> <tr><td>SWING</td><td>3/4"</td><td>48-HSCV075TS</td><td></td></tr> <tr><td>CHECK</td><td>1"</td><td>48-HSCV100TS</td><td></td></tr> <tr><td></td><td>1-1/4"</td><td>48-HSCV125TS</td><td></td></tr> <tr><td></td><td>1-1/2"</td><td>48-HSCV150TS</td><td></td></tr> <tr><td></td><td>2"</td><td>48-HSCV200TS</td><td></td></tr> <tr><td></td><td>2-1/2"</td><td>48-HSCV250TS</td><td></td></tr> <tr><td></td><td>3"</td><td>48-HSCV300TS</td><td></td></tr> <tr><td></td><td>4"</td><td>48-HSCV400TS</td><td></td></tr> </table>				BRASS	1/2"	48-HSCV050TS		SWING	3/4"	48-HSCV075TS		CHECK	1"	48-HSCV100TS			1-1/4"	48-HSCV125TS			1-1/2"	48-HSCV150TS			2"	48-HSCV200TS			2-1/2"	48-HSCV250TS			3"	48-HSCV300TS			4"	48-HSCV400TS																					
BRASS	1/2"	48-HSCV050TS																																																													
SWING	3/4"	48-HSCV075TS																																																													
CHECK	1"	48-HSCV100TS																																																													
	1-1/4"	48-HSCV125TS																																																													
	1-1/2"	48-HSCV150TS																																																													
	2"	48-HSCV200TS																																																													
	2-1/2"	48-HSCV250TS																																																													
	3"	48-HSCV300TS																																																													
	4"	48-HSCV400TS																																																													
BRASS	1/2"	48-HSCV050TS																																																													
SWING	3/4"	48-HSCV075TS																																																													
CHECK	1"	48-HSCV100TS																																																													
	1-1/4"	48-HSCV125TS																																																													
	1-1/2"	48-HSCV150TS																																																													
	2"	48-HSCV200TS																																																													
	2-1/2"	48-HSCV250TS																																																													
	3"	48-HSCV300TS																																																													
	4"	48-HSCV400TS																																																													
				<table border="1" style="width: 100%; border-collapse: collapse;"> <tr><td>BRASS</td><td>3/4" PRESET 75#</td><td>48-EB86U1000</td><td></td></tr> <tr><td>PRESSURE</td><td>1" PRESET 75#</td><td>48-EB86U2000</td><td></td></tr> <tr><td>REGULATOR</td><td></td><td></td><td></td></tr> </table>				BRASS	3/4" PRESET 75#	48-EB86U1000		PRESSURE	1" PRESET 75#	48-EB86U2000		REGULATOR																																															
BRASS	3/4" PRESET 75#	48-EB86U1000																																																													
PRESSURE	1" PRESET 75#	48-EB86U2000																																																													
REGULATOR																																																															

TITAN INDUSTRIES, INC.
a world of products for the world of water

Prices are subject to change without notice.

Returns are subject to a restock fee.

Special Orders are non-returnable.

CYCLE STOP VALVES AND BRASS VALVES

Item	Size	Part No.	List Price	Item	Size	Part No.	List Price
CSV1				DOLE FLOW RESTRICTION VALVE	4 GAL 1/2"	48-D40V00000	
1" 30 GPM 30 PSI		48-CSV130000			2 GAL 3/4"	48-D20V00000	
1" 30 GPM 40 PSI		48-CSV140000			3 GAL 3/4"	48-D30V00000	
1" 30 GPM 50 PSI		48-CSV150000			5 GAL 3/4"	48-D50V00000	
1" 30 GPM 60 PSI		48-CSV160000			7 GAL 3/4"	48-D70V00000	
IN THE WELL COUPLING		48-CSCPVC000			8 GAL 3/4"	48-D80V00000	
CSV1Z					10 GAL 3/4"	48-D100V0000	
1-1/4" 30 GPM THREADED		48-CSV1Z0000			3 GAL 1"	48-D301V0000	
CSV2W					6 GAL 1"	48-D601V0000	
1" THR 35 GPM 25-75 PSI		48-CS2W10T20			9 GAL 1"	48-9DV000000	
1" THR 35 GPM 50-145 PSI		48-CS2W10T50			10 GAL 1"	48-D101V0000	
1-1/4" THR 60 GPM 25-75 PSI		48-CS2W12T20			15 GAL 1"	48-D150V0000	
1-1/4" THR 60 GPM 50-145 PSI		48-CS2W12T50			25 GAL 1"	48-D250V0000	
CSV3B					30 GAL 1"	48-D300V0000	
2" 150GPM THREADED		48-CSV3B2T00			40 GAL 2-1/2"	48-D400V0000	
3" 300 GPM THREADED		48-CSV3B3T00			50 GAL 2-1/2"	48-D500V0000	
4" 500 GPM FLANGED		48-CSV3B4F00		60 GAL 2-1/2"	48-D600V0000		
6" 800 GPM FLANGED		48-CSV3B6F00		70 GAL 2-1/2"	48-D700V0000		
CSV3R				80 GAL 2-1/2"	48-D800V0000		
2" 150 GPM WAFER FLANGED		48-CSV3R2F00		100 GAL 3"	48-D1000V0000		
3" 300 GPM WAFER FLANGED		48-CSV3R3F00		BRASS GAS COCK SHUT OFF VALVE			
4" 500 GPM WAFER FLANGED		48-CSV3R4F00		1/4" FLAT	48-BGASVF020		
6" 1200 GPM FLANGED		48-CSV3R6F00		1/2" FLAT	48-BGASVF050		
8" 2000 GPM FLANGED		48-CSV3R8F00		1-1/2" FLAT	48-BGASVF150		
10" 3000 GPM FLANGED		48-CSV3R10F0		1/2" SQUARE	48-BGASVS050		
12" 5000 GPM FLANGED		48-CSV3R12F0		3/4" SQUARE	48-BGASVS070		
				1" SQUARE	48-BGASVS100		
				1-1/4" SQUARE	48-BGASVS120		
				1-1/2" SQUARE	48-BGASVS150		
				HOSE BIBBS			
				1/2"	48-HHB500000		
				3/4"	48-HHB750000		
				3/4"	48-HHBP75000		
				1/4 TURN HOSE BIBBS			
				1/2"	48-IHBB50000		
				3/4"	48-IHBB75000		
				BRASS BOILER			
				1/2"	48-BDHBD5000		
				3/4"	48-BDHBD7500		
				FULL FLOW BOILER DRAIN			
				1/2"	48-BDIBD50SB		
				3/4"	48-BDIBD75SB		

Prices are subject to change without notice.

Returns are subject to a restock fee.

Special Orders are non-returnable.

TITAN INDUSTRIES, INC.
a world of products for the world of water

VALVES, SADDLES & ACCESSORIES

Item	Size	Part No.	List Price	Item	Size	Part No.	List Price
MUELLER MINNEAPOLIS PATTERN CURB STOP	3/4" 1" 1-1/4" 1-1/2" 2"	49-H10287075 49-H10287100 49-H10287125 49-H10287150 49-H10287200		CLAMP ON BRONZE SADDLE	1" X 2" 1" X 4" 4" X 3/4" 6" X 1" 6" X 3/4"	49-BS3802102 49-BS3802104 49-BS3802407 49-BS3802601 49-BS3802607	
MUELLER MINNEAPOLIS PATTERN CURB STOP & WASTE	3/4" & WASTE 1" & WASTE 1-1/4" & WASTE 1-1/2" & WASTE 2" & WASTE	49-H10288075 49-H10288100 49-H10288125 49-H10288150 49-H10288200		WATER METER	1-1/2" MASTER 2"	49-WMMM6T010 49-WMMM71010	
MUELLER ARCH PATTERN CURB STOP	3/4" 1" 1-1/4" 1-1/2" 2"	49-H10283075 49-H10283100 49-H10283125 49-H10283150 49-H10283200					
MUELLER ARCH PATTERN CURB STOP & WASTE	3/4" 1" 1-1/4" 1-1/2" 2"	49-H1028307W 49-H1028310W 49-H1028312W 49-H1028315W 49-H1028320W					
CURB BOX	1-1/2" X 5'	49-CB5614550					
CURB BOX ADAPTER	1-1/4" 2" 3" 2" X 2-1/2" 5"	49-H10344125 49-H10344200 49-H10344300 49-H10344604 49-H10385000					
SHUT-OFF HANDLE	3' 4' 6'	49-SOHAND030 49-SOHAND040 49-SOHAND060					
CORP STOP	3/4" 1-1/2"	49-CS4701007 49-CS4701015					
MCDONALD STOP	1-1/4"	49-MCSTOP125					
BRASS GATE VALVE	1/2" CU 3/4" CU 1/2" THREADED 3/4" THREADED	48-HSTPV50C0 48-HSTPV75C0 48-HSTPV50T0 48-HSTPV75T0					
BRASS GATE STOP & WASTE VALVE FITS 1/2" WASTE CAP ONLY FITS 3/4" WASTE CAP ONLY	1/2" CU 3/4" CU 1/2" THREADED 3/4" THREADED	48-HSWV50C00 48-HSWV75C00 48-HSWV50T00 48-HSWV75T00 48-HSWVC3800 48-HSWVC5160					

TITAN INDUSTRIES, INC.
a world of products for the world of water

Prices are subject to change without notice.

Returns are subject to a restock fee.

Special Orders are non-returnable.

NOTES

CALL US TODAY!

PO Box 308
East Hwy 30
Paxton, Nebraska 69155
800-658-4086
308-239-4281
308-239-4474 (fax)

11555 S. Highway 283
Dodge City, Kansas 67801
800-658-4078
620-225-6201
620-225-1171 (fax)

1203 S.E. Grand Blvd.
Oklahoma, City, Oklahoma 73129
800-749-8659
405-677-1290
405-677-1296 (fax)

112 Grant - Aurora Industrial Park
Aurora, Nebraska 68818
800-255-4188
402-694-4188
402-694-4511 (fax)

1912 West Harry
Wichita, Kansas 67213
866-323-9111
316-262-9111
316-262-9119 (fax)

TITAN INDUSTRIES, INC.
a world of products for the world of water

WINDMILLS & ACCESSORIES

Item	Size	Part No.	List Price	Item	Size	Part No.	List Price
702 COMPLETE WINDMILLS	6'	08-702XC0000		MOTOR & HOOD	6'	08-702X00000	
	8'	08-702AC0000			8'	08-702A00000	
	10'	08-702BC0000			10'	08-702B00000	
2 YEAR WARRANTY ON COMPLETE WINDMILLS DOES NOT INCLUDE TOWER OR STUB TOWER				NEW MOTOR & HOOD	8'	08-08MN00000	
COMPLETE WINDMILLS INCLUDE				HOT-DIPPED WHEEL	6' 8' 10'	08-799WX0000 08-799WA0000 08-799WB0000	
TAIL VANE SPRING (1)		08-28		HOT-DIPPED WHEEL W/ TIMEABLE SPOKES	6' 8' 10'	08-799WSTX00 08-799WSTA00 08-799WSTB00	
PUMP ROD (1)		08-171		4 POST STUB TOWER 3'	REBUILT 6' & 8' 10' NEW 6' & 8' 10'	08-PSTX00000 08-PSTB00000 08-PSTXN0000 08-PSTBN0000	
FURL HANDLE (1)		08-243		4 POST STUB TOWER 4'	REBUILT 6' & 8' NEW 6' & 8'	08-PST4X0000 08-PST4XN000	
TAIL PIN (1)		08-510		4 POST STUB TOWER 5'	REBUILT 10'	08-PST5B0000	
FURL LEVER (1)		08-609		ANCHOR POST/SET	6' & 8' 10' 12'	08-68AP00000 08-10AP00000 08-12AP00000	
UPPER FURL RING (1)		08-613		4 POST MILL PLATFORM	6' & 8' 10'	08-6MPF00000 08-10MPF0000	
BRAKE APPARATUS (1)		08-632		FIBERGLASS ROD	5/8"X21' WITH GALVANIZED ENDS 5/8"X21' WITH STAINLESS ENDS	09-FGLR0621G 09-FGLR0621S	
TAIL BUFFER (1)		08-659		FIB. GLASS REPAIR ENDS	5/8" FEM 5/8" MALE	09-FRRK058FM 09-FRRK058MM	
MAST PIPE WITH BASE (1)		08-661		T & C GALVANIZED PUMP ROD	7/16"X18' 7/16"X21'	09-GR71618TC 09-GR71621TC	
MOTOR AND HELMET (1)		08-702		GALV ROD COUPLERS	3/8"X3/8" 7/16"X7/16" 7/16"X3/8"	09-GRC8075B1 09-GRC8075D1 09-GRC8075E1	
WHEEL ARMS (12)		08-736					
COMPLETE TAIL (1)		08-748					
FAN SECTIONS (6)		08-799					
702 PARTIAL WINDMILL	6' 8' 10'	08-702XP0000 08-702AP0000 08-702BP0000					
WITH NEW WHEEL AND REGULAR SPOKES							
PARTIAL WINDMILLS INCLUDE							
MOTOR AND HELMET (1)		08-702					
PUMP ROD (1)		08-171					
TAIL PIN (1)		08-510					
WHEEL ARMS (12)		08-736					
FAN SECTIONS (6)		08-799					
MAST PIPE WITH BASE (1)		08-661					
WINDPOWER WINDMILL OIL	Gallon Quart	09-WINDOILGL 09-WINDOILQT					
BASE FLANGES	1" 1-1/4" 2"	09-BASEF10MP 09-BASEF11MP 09-BASEF13MP					

TITAN INDUSTRIES, INC.
a world of products for the world of water

Prices are subject to change without notice.

Returns are subject to a restock fee.

Special Orders are non-returnable.

WINDMILL PARTS

Item	Size	Part No.	List Price	Item	Size	Part No.	List Price
SAIL W/17 TIE	6'	08-100X00000		HOOP RIVET	6'	08-508RX0000	
	8'	08-100A00000			8'	08-508R00000	
	10'	08-100B00000					
TOP FAN CLIP	6'	08-101X00000		TAIL PIN	6'	08-510X00000	
	8'	08-101A00000			8'	08-510A00000	
	10'	08-101B00000			10'	08-510B00000	
			12'		08-510D00000		
PUMP ROD	6'	08-171X00000		SPOUT WASHER SPRING	6'	08-517X00000	
	8'	08-171A00000			8'	08-517A00000	
	10'	08-171B00000			10'	08-517B00000	
FURL HANDLE	6'	08-243X00000		OIL COLLECTOR	6'	08-520X00000	
	8'	08-243A00000			8'	08-520A00000	
	10'	08-243B00000			10'	08-520B00000	
TAIL SPRING	6'	08-28X000000		SPLIT WASHER	6'	08-521X00000	
	8'	08-28A000000			8'	08-521A00000	
	10'	08-28B000000			10'	08-521B00000	
	12'	08-28D000000					
TAIL VANE	6'	08-31X000000		GUIDE WHEEL SHAFT	6'	08-522X00000	
	8'	08-31A000000			8'	08-522A00000	
	10'	08-31B000000			10'	08-522B00000	
			12'		08-522D00000		
U-BOLT	6'	08-334X00000		GUIDE WHEEL	6'	08-523X00000	
	8'	08-334A00000			8'	08-523A00000	
	10'	08-334B00000			10'	08-523B00000	
OUTER BAND	6'	08-34X000000		FURL LINK	6'	08-527X00000	
	8'	08-34A000000			8'	08-527A00000	
	10'	08-34B000000			10'	08-527B00000	
INNER BAND	6'	08-35X000000		HELMET	6'	08-560X00000	
	8'	08-35A000000			8'	08-560A00000	
	10'	08-35B000000			10'	08-560B00000	
			12'		08-560D00000		
NARROW U-BOLT TAIL HARDWARE	6'	08-44X000000		THIN TURNABLE WASHER	6'	08-576X00000	
	8'	08-44A000000			8'	08-576A00000	
	10'	08-44B000000			10'	08-576B00000	
WIDE U-BOLT TAIL HARDWARE	6'	08-47X000000		THICK TURNABLE WASHER	6'	08-576TKX000	
	8'	08-47A000000			8'	08-576TKA000	
	10'	08-47B000000			10'	08-576TKB000	
OIL RING	6'	08-507X00000		MAST PIPE CUP	6'	08-577A00000	
	8'	08-507A00000			8'	08-577X00000	
	10'	08-507B00000					
HOOP	6'	08-508X00000		NUT FOR MAST	6'	08-578X00000	
	8'	08-508A00000			8'	08-578A00000	
	10'	08-508B00000			10'	08-578B00000	

TITAN INDUSTRIES, INC.
a world of products for the world of water

*Prices are subject to change without notice.
Returns are subject to a restock fee.
Special Orders are non-returnable.*

WINDMILL PARTS

Item	Size	Part No.	List Price	Item	Size	Part No.	List Price
WASHER FOR MAST	6'	08-579X00000		TAIL BUFFER CAST	6'	08-655X00000	
	8'	08-579A00000			8'	08-655A00000	
	10'	08-579B00000			10'	08-655B00000	
TAIL SPRING HOLDER	6'	08-580X00000		BOLT & SPRING	6'	08-657658X00	
	8'	08-580A00000			8'	08-657658A00	
	10'	08-580B00000			10'	08-657658B00	
TAIL BONE CAST	6'	08-585X00000		TAIL BUFFER	6'	08-659X00000	
	8'	08-585A00000			8'	08-659A00000	
	10'	08-585B00000			10'	08-659B00000	
STUD & NUT	6'	08-588X00000		MAST PIPE	6'	08-661X00000	
	8'	08-588A00000			8'	08-661A00000	
	10'	08-588B00000			10'	08-661B00000	
YOKE	6'	08-608X00000		4-POST BASE	6' & 8'	08-674X00000	
	8'	08-608A00000			10'	08-674B00000	
	10'	08-608B00000					
FURL LEVER	6'	08-609X00000		3-POST BASE	6' & 8'	08-675X00000	
	8'	08-609A00000			8'	08-675A00000	
	10'	08-609B00000					
SPLIT FURL LEVER	6'	08-609SX0000		MAST ONLY	6'	08-676X00000	
	8'	08-609SA0000			8'	08-676A00000	
	10'	08-609SB0000			10'	08-676B00000	
PIN FOR 608	6'	08-610X00000		PITMAN ARMS	6'	08-686X00000	
	8'	08-610A00000			8'	08-686A00000	
	10'	08-610B00000			10'	08-686B00000	
UPPER FURL RING	6'	08-613X00000		BRAKE BAND	6'	08-690X00000	
	8'	08-613A00000			8'	08-690A00000	
	10'	08-613B00000			10'	08-690B00000	
PIN FOR 686	6'	08-622X00000		HUB	6'	08-703X00000	
	8'	08-622A00000			8'	08-703A00000	
	10'	08-622B00000			10'	08-703B00000	
	12'	08-622D00000					
BRAKE APPARATUS	6'	08-632X00000		PINION GEAR	6'	08-704X00000	
	8'	08-632A00000			8'	08-704A00000	
	10'	08-632B00000			10'	08-704B00000	
TAIL BONE	6'	08-639X00000		12'	08-704D00000		
	8'	08-639A00000		LARGE GEAR	6'	08-705X00000	
	10'	08-639B00000			8'	08-705A00000	
			10'		08-705B00000		
FRONT CAST FOR 659	6'	08-654X00000		REBUILD KIT	6'	08-707X00000	
	8'	08-654A00000			8'	08-707A00000	
	10'	08-654B00000			10'	08-707B00000	
				PINION BEARING	6'	08-708X00000	
			8'		08-708A00000		
			10'		08-708B00000		
			12'		08-708D00000		

TITAN INDUSTRIES, INC.
a world of products for the world of water

012004

Prices are subject to change without notice.

Returns are subject to a restock fee.

Special Orders are non-returnable.

PAGE D-03

WINDMILL PARTS

Item	Size	Part No.	List Price	Item	Size	Part No.	List Price
NUT FOR 520	6'	08-711X00000		TAIL COMPLETE	6'	08-748X00000	
	8'	08-711A00000			8'	08-748A00000	
	10'	08-711B00000			10'	08-748B00000	
SPOUT WASHER	6'	08-718X00000		TAIL COMPLETE REBUILT	6'	08-748XR0000	
	8'	08-718A00000			8'	08-748AR0000	
	10'	08-718B00000			10'	08-748BR0000	
SHAFT FOR 703	6'	08-719X00000		BEARING BAR	6'	08-751X00000	
	8'	08-719A00000			8'	08-751A00000	
	10'	08-719B00000			10'	08-751B00000	
SHAFT FOR 705	6'	08-720X00000		LG GEAR BEARINGS	6'	08-752X00000	
	8'	08-720A00000			8'	08-752A00000	
	10'	08-720B00000			10'	08-752B00000	
PIN FOR 720	6'	08-721X00000		LG GEAR ASSEMBLY	6'	08-755X00000	
	8'	08-721A00000			8'	08-755A00000	
	10'	08-721B00000			10'	08-755B00000	
	12'	08-721D00000					
PIN FOR 719	6'	08-729X00000		BRAKE LEVER	6'	08-786X00000	
	8'	08-729A00000			8'	08-786A00000	
	10'	08-729B00000			10'	08-786B00000	
SLEEVE BEARING	6'	08-730X00000		FAN SECTION	6'	08-799X00000	
	8'	08-730A00000			8'	08-799A00000	
	10'	08-730B00000			10'	08-799B00000	
12'	08-730D00000		12'		08-799D00000		
SPOKES TIMEABLE	6'	08-736X00000		HOOD NUT	6'	08-565000000	
	8'	08-736A00000			8'	08-565000000	
	10'	08-736B00000			10'	08-565000000	
	12'	08-736D00000					
REPAIR CLIP	6'	08-737X00000		WHEEL ARM (TIMABLE SPOKE)	6'	08-736TX0000	
	8'	08-737A00000			8'	08-736TA0000	
	10'	08-737B00000			10'	08-736TB0000	
PINION KEY	6'	08-744X00000		PLATFORM	6' & 8'	08-T1X000000	
	8'	08-744A00000			10'	08-T1B000000	
	10'	08-744B00000					
HUB KEY	6'	08-745X00000		PLATFORM BOLT	6' & 8'	08-T20000000	
	8'	08-745A00000			10'	08-T20000000	
	10'	08-745B00000			12'	08-T20000000	
STUB TOWER CLAMPS	REBUILT	6' & 8'	08-T3X000000	LOUP STEP	6' & 8'	08-T40000000	
		10'	08-T3B000000			10'	08-T40000000
	NEW	6' & 8'	08-T3XN00000				
		10'	08-T3BN00000				

TITAN INDUSTRIES, INC.
a world of products for the world of water

*Prices are subject to change without notice.
Returns are subject to a restock fee.
Special Orders are non-returnable.*

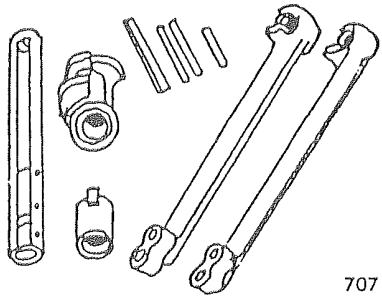

707

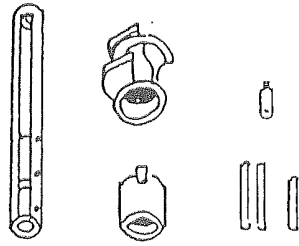

770

702 and 602 Windmill Parts

702 — 1933 and Newer

Parts with check mark (✓)
are items for 602 Model,
made before 1933

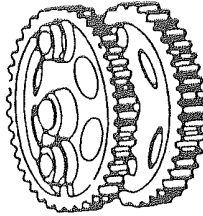

755
✓606
✓553
✓559

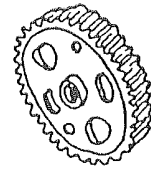
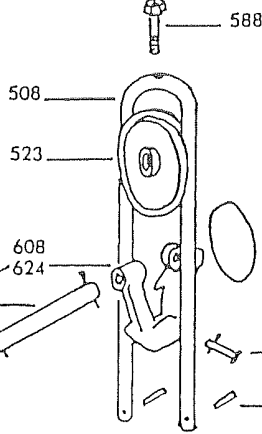
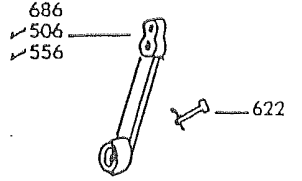

705
✓605
✓555
✓558

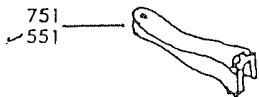

751
✓551

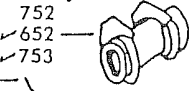

752
✓652
✓753

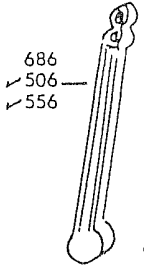

686
✓506
✓556

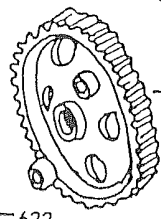

705
✓604
✓554
✓557



721

720

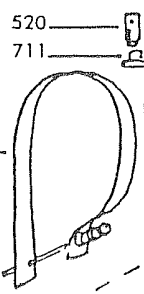

520
711

690

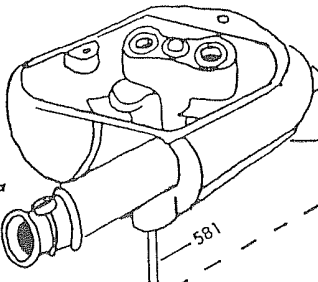

702
602

781

704
504

708

704
504

718
618

517

719
619

703
503

703A
503A

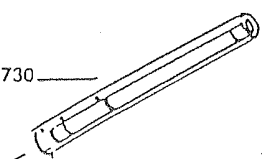

730

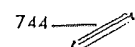

744

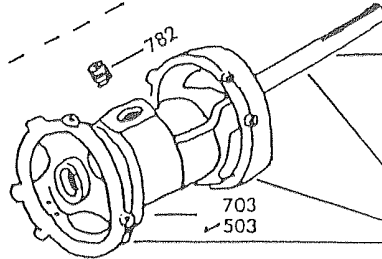

782

719
619

703
503

703A
503A

745

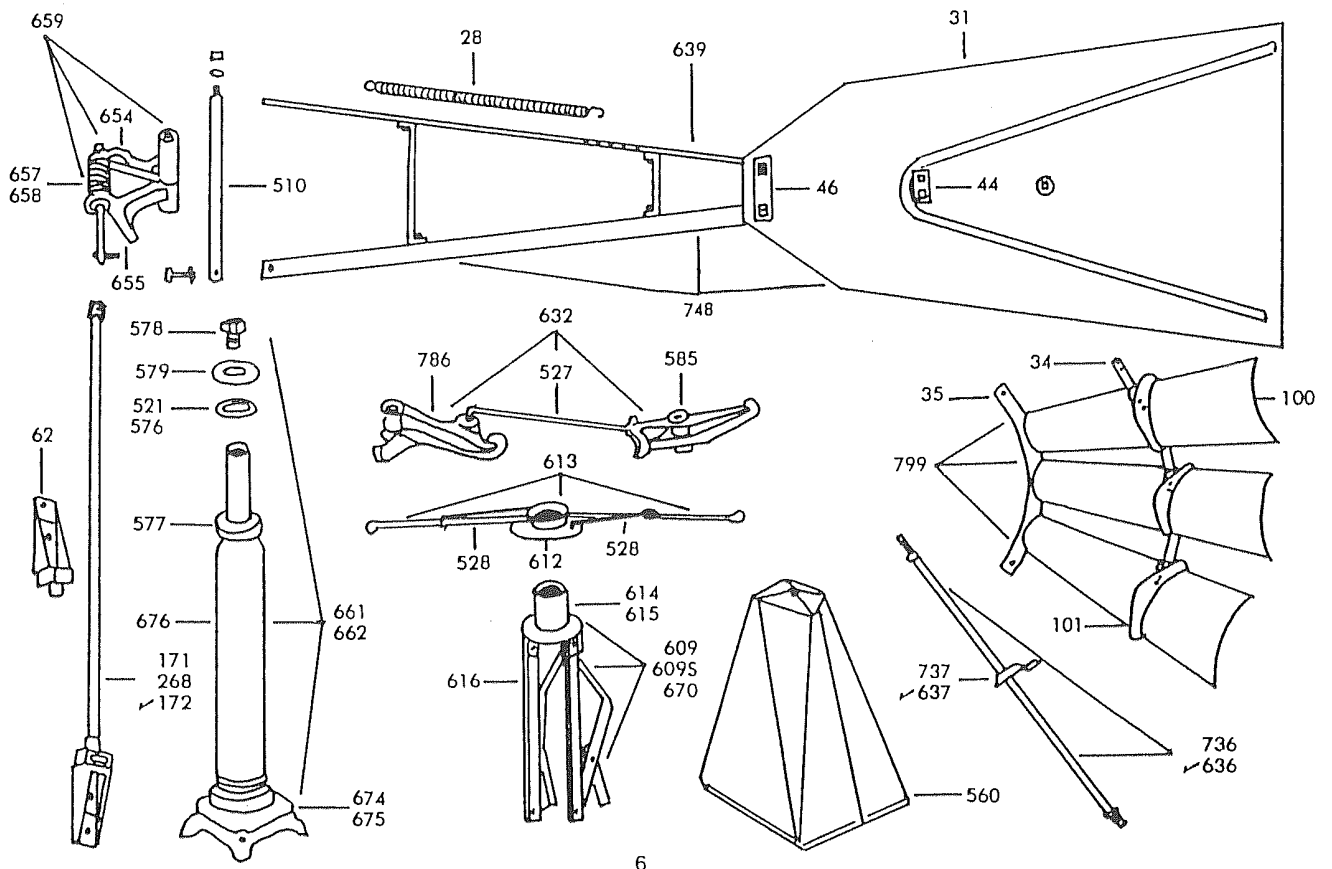
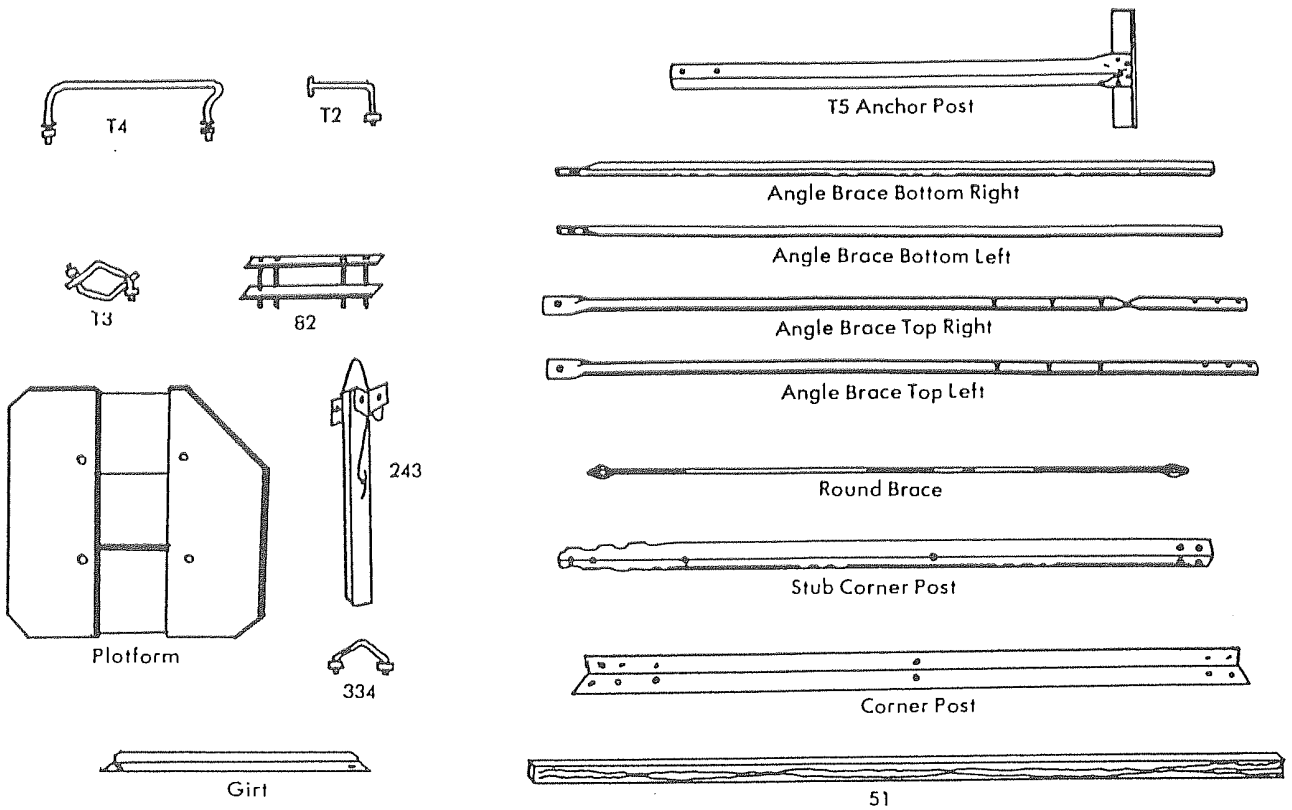

WINDMILL ACCESSORIES

Item	Size	Part No.	List Price	Item	Size	Part No.	List Price
442 BRASS CYLINDER	1-11/16" x 8"	09-C42B727A0		441, 442 & A40 PLUNGER VALVE	1-11/16"	09-CRA48522A	
	1-11/16" x 10"	09-C42B727B0			2"	09-CRA48522C	
	1-13/16" x 8"	09-C42B727C0			2-1/4"	09-CRA48522D	
	1-13/16" x 10"	09-C42B727D3			2-1/2"	09-CRA48522F	
	2" x 10"	09-C42B727F0			3"	09-CRA48522J	
	2-1/4" x 10"	09-C42B727DA		442 PLUNGER		2"	09-CRA4899C0
	2-1/4" x 10"	09-C42B727J0		POPPET		2-1/2"	09-CRA4899E0
	2-1/2" x 10"	09-C42B727L0				3"	09-CRA4899G0
3" x 10"	09-C42B727FA						
449B BRASS CYLINDER	1-7/8" x 14"	09-C49B737H0		449 & 652 PLUNGER		1-7/8"	09-CRA48530B
	1-7/8" x 20"	09-C49B737R0				2-1/4"	09-CRA48530C
	1-7/8" x 26"	09-C49B737W0		449 & 652 CHECK		1-7/8"	09-CR498531B
	2-1/4" x 13"	09-C49B737BA				2-1/4"	09-CR498531C
	2-1/4" x 19"	09-C49B737GA				2-3/4"	09-CR498531D
	2-1/4" x 25"	09-C49B737LA		A40 CHECK VALVE		2"	09-CRA48724A
	2-3/4" x 12"	09-C49B737UA				2-1/4"	09-CRA48724B
	2-3/4" x 18"	09-C49B737ZA				2-1/2"	09-CRA48724C
2-3/4" x 24"	09-C49B737EB				3"	09-CRA48724D	
A40 CAST IRON BRASS LINED CYLINDER	2" x 10"	09-CA48725E7		INTAKE SCREEN		1-1/4"X8"	09-01208INTS
	2-1/4" x 10"	09-CA48725E1		BRASS PIPE WORKING BARREL		3"X30"	09-BRSBARL03
	2-1/2" x 6"	09-CA48725E6					
	2-1/2" x 10"	09-CA48725E3					
	3" x 6"	09-CA48725E5					
3" x 10"	09-CA48725E9						
A76 CYLINDER	2" x 12"	09-CA7921198					
442 TOP CAP	1-13/16"	09-CR428248D					
442 BOTTOM CAP W/CHECK	1-11/16"	09-CR428853U					
	2"	09-CR428853W					
	2-1/4"	09-CR428853X					
	2-1/2"	09-CR428853Z					
442 CHECK POPPET	2"	09-CR428854C					
	2-1/4" x 2-1/2"	09-CR428854D					
460 PLUNGER	2"	09-CR4609224					
	2-1/2"	09-CR4692495					
	3"	09-CR4692498					
	4"	09-CR4692501					
461 CHECK	2-1/2"	09-CR6192384					
	3"	09-CR6192387					
	4"	09-CR6192390					
461 RUBBER CYLINDER PACKER REPL.	4"	09-CR6170340					

TITAN INDUSTRIES, INC.
a world of products for the world of water

Prices are subject to change without notice.

Returns are subject to a restock fee.

Special Orders are non-returnable.

WINDMILL ACCESSORIES

Item	Size	Part No.	List Price	Item	Size	Part No.	List Price
OIL FILL LEATHER 704/46	1-7/8" x 1-1/4"	09-L70422000		WATER-PROOF CUP LEATHER 711/44 CONT.	2-1/2" x 1-1/2"	09-L71135700	
	2-1/4" x 1-1/2"	09-L70433400			2-1/2" x 1-5/8"	09-L71135800	
	2-1/2" x 1-5/8"	09-L70435800			2-1/2" x 1-11/16"	09-L71135900	
	2-3/4" x 1-7/8"	09-L70438400			2-3/4" x 1-7/8"	09-L71138400	
BLACK CUP LEATHER 706/42	1-1/2" x 5/8"	09-L70611200			3" x 1-1/2"	09-L71140600	
	1-5/8" x 3/8"	09-L70612700			3" x 1-7/8"	09-L71140900	
	1-11/16" x 1-1/8"	09-L70615500			3" x 2"	09-L71141000	
	1-13/16" x 1-3/16"	09-L70619800			3-1/16" x 1-7/8"	09-L71143500	
	1-7/8" x 1-1/4"	09-L70622000			3-1/16" x 2"	09-L71143600	
	2" x 3/16"	09-L70626200			3-1/2" x 2-1/2"	09-L71146400	
	2" x 1-5/16"	09-L70626400			3-3/4" x 2-5/8"	09-L71149200	
	2-1/8" x 1-3/8"	09-L70631000			4" x 3"	09-L71152100	
	2-1/4" x 1-3/8"	09-L70633300					
	2-1/2" x 1/2"	09-L70634500			NEOFAB CUP LEATHERS NEO/86	1-11/16" x 1"	09-LNEO15400
	2-1/2" x 1-5/8"	09-L70635800		1-7/8" x 1-1/4"	09-LNEO22000		
	2-1/2" x 1-11/16"	09-L70635900		2-1/4" x 1-1/2"	09-LNEO33400		
	2-1/2" x 1-7/8"	09-L70636000					
	3-3/4" x 2-5/8"	09-L70649200		UNIVERSAL PACKING LEATHER 708/57	2" x 1-3/8"	09-LR7020001	
	4" x 3/4"	09-L70650900		2-1/2" x 1-7/8"	09-LR7020801		
	4" x 2-5/8"	09-L70651900		2-3/4" x 2-1/8"	09-LR7021202		
	4" x 2-3/4"	09-L70652000		3" x 2-3/8"	09-LR7030002		
	4" x 3"	09-L70652100		3-1/2" x 2-7/8"	09-LR7030821		
	GRAPHITE CUP LEATHER 707/45	1-7/8" x 1-1/4"	09-L70722000		UNIVERSAL VALVE LEATHER 700/55	2" x 2-1/2"	09-LV5020802
1-7/8" x 1-5/16"		09-L70722100		2-1/4" x 2-3/4"	09-LV5021202		
2" x 1-5/16"		09-L70726400		2-1/2" x 3"	09-LV5030002		
3" x 2"		09-L70741000		3" x 3-1/2"	09-LV5030802		
WATER-PROOF CUP LEATHER 711/44	1" x 3/8"	09-L71102200		3-1/4" x 3-3/4"	09-LV5031203		
	1-1/4" x 3/8"	09-L71106100		3-1/2" x 4"	09-LV5040003		
	1-1/2" x 3/8"	09-L71110900		4" x 4-1/2"	09-LV5040803		
	1-1/2" x 5/8"	09-L71111200		4-1/4" x 5"	09-LV5050004		
	1-5/8" x 5/8"	09-L71113000		4-1/2" x 5-1/4"	09-LV5050404		
	1-11/16" x 1-3/16"	09-L71115100		5" x 5-3/4"	09-LV5051205		
	1-11/16" x 1"	09-L71115400		6" x 6-3/4"	09-LV5061205		
	1-11/16" x 1-1/8"	09-L71115500					
	1-3/4" x 1-1/8"	09-L71117500					
	1-7/8" x 1-3/16"	09-L71121900					
	1-7/8" x 1-1/4"	09-L71122000					
	1-7/8" x 1-5/16"	09-L71122100					
	1-5/16" x 1-1/8"	09-L71122600					
	1-15/16" x 1-3/16"	09-L71124000					
	1-15/16" x 1-5/16"	09-L71124200					
	2" x 5/8"	09-L71125500					
	2" x 1-3/16"	09-L71126200					
	2" x 1-1/4"	09-L71126300					
	2" x 1-5/16"	09-L71126400					
	2-1/16" x 1-5/16"	09-L71128600					
	2-1/4" x 1-1/4"	09-L71133100					
	2-1/4" x 1-5/16"	09-L71133200					
	2-1/4" x 1-3/8"	09-L71133300					
	2-1/4" x 1-1/2"	09-L71133400					
	2-1/4" x 1-5/8"	09-L71133500					
	2-1/2" x 5/8"	09-L71134600					

Prices are subject to change without notice.

Returns are subject to a restock fee.

Special Orders are non-returnable.

TITAN INDUSTRIES, INC.
a world of products for the world of water

BOTTOMLESS TANKS, VALVES & ACCESSORIES

Item	Size	Part No.	List Price	Item	Size	Part No.	List Price
GALVANIZED BOTTOMLESS TANK	12' (4SHEETS)	10-BL1200000		HUDSON VALVE		10-R400HUDSN	
	15' (5SHEETS)	10-BL1500000			VALVE REPAIR KIT	1"	10-K40000000
	18' (6SHEETS)	10-BL1800000		FOR HUDSON VALVE			
	21' (7SHEETS)	10-BL2100000		CONTINUOUS FLOW DISC	1"	10-P02000000	
	24' (8SHEETS)	10-BL2400000			FOR HUDSON VALVE		
	27' (9SHEETS)	10-BL2700000					
30' (10SHEETS)	10-BL3000000						
BOB VALVES AND PARTS							
BOB VALVE	3/8"	10-R40003000		FLOATS			
	1/2"	10-R40005000		COPPER FLOAT	4"	10-R44040000	
	3/4"	10-R40007000			5"	10-R44050000	
	3/4" COMPLETE	10-R40007C00		6"	10-R44060000		
	1"	10-R40010000		PLASTIC FLOAT	5"	10-PF5000000	
			6"		10-PF6000000		
HEAVY DUTY BOB VALVE	1-1/2"	10-R60010500		FLAT GALVANIZED TANK FLOAT	8"	10-940015000	
PLUNGER REPLACEMENT ASSEMBLY FOR BOB VALVES	3/8"	10-100032100			10"	10-940016000	
	1/2"	10-106524100			12"	10-940018000	
	3/4"	10-106270100		TANK BRACKET	FOR FLOAT SWITCH	10-TTFSB0000	
	1"	10-100035100					
LONG ARM SHORT ARM		10-R46000000 10-R47000000		STOCK WATERING COMPACT VALVE	W/ PLASTIC CASE	10-B82500000	
THUMB SCREW		10-R48000000					
COTTER PIN		10-R48100000		WELL HOUSES AND CISTRIN			
BRASS SCREWS		10-R40010550		INSULATED METAL WELL HOUSE	4'	10-WELHOUSE40	
STEM		10-R45010000					
DISC	FOR R400-1/2 FOR R400-3/4	10-R40063000 10-R40073000		DYER WELL HOUSE		10-WELLHOUSE	
BRASS ROD	1/4" X 12"	10-BROD00212		CISTRIN STORAGE TANK W/LEGS	1025 GAL.	10-WT1443700	
	7/16" X 12"	10-BROD71612					
	1/4" X 20"	10-930120000		HOOP ASSEMBLY	W/BOLT PACKAGE	10-WT4590170	
	1/4"X10"W/SWIVEL	10-R38000000					
	1-1/4" X 10"	10-R38012000					
PIGTAIL TIE ROD		10-950100000					
CLAMP	BRONZE	10-BRONZCLMP					
SWIVEL	W/HOOK	10-V20200000					
	w/10" CHAIN	10-V20210000					

TITAN INDUSTRIES, INC.
a world of products for the world of water

Prices are subject to change without notice.
Returns are subject to a restock fee.
Special Orders are non-returnable.

NOTES

CALL US TODAY!

PO Box 308
East Hwy 30
Paxton, Nebraska 69155
800-658-4086
308-239-4281
308-239-4474 (fax)

11555 S. Highway 283
Dodge City, Kansas 67801
800-658-4078
620-225-6201
620-225-1171 (fax)

1203 S.E. Grand Blvd.
Oklahoma, City, Oklahoma 73129
800-749-8659
405-677-1290
405-677-1296 (fax)

112 Grant - Aurora Industrial Park
Aurora, Nebraska 68818
800-255-4188
402-694-4188
402-694-4511 (fax)

1912 West Harry
Wichita, Kansas 67213
866-323-9111
316-262-9111
316-262-9119 (fax)

TITAN INDUSTRIES, INC.
a world of products for the world of water

GALVANIZED PIPE

GALVANIZED DOMESTIC T&C		
Part No.	Description	List Price
SGP003AME21TC	3/8" X 21'	
SGP005AME21TC	1/2" X 21'	
SGP007AME21TC	3/4" X 21'	
SGP010AME18TC	1" X 18'	
SGP010AME21TC	1" X 21'	
SGP012AME18TC	1-1/4" X 18'	
SGP012AME21TC	1-1/4" X 21'	
SGP015AME18TC	1-1/2" X 18'	
SGP015AME21TC	1-1/2" X 21'	
SGP020AME21TC	2" X 21'	
SGP025AME21TC	2-1/2" X 21'	
SGP030AME21TC	3" X 21'	
SGP040AME21TC	4" X 21'	
SGP050AME21TC	5" X 21'	
SGP060AME21TC	6" X 21'	
IMPORT GALVANIZED T&C		
Part No.	Description	List Price
SGP005IMP21TC	1/2" X 21'	
SGP007IMP21TC	3/4" X 21'	
SGP010IMP18TC	1" X 18'	
SGP010IMP21TC	1" X 21'	
SGP012IMP18TC	1-1/4" X 18'	
SGP012IMP21TC	1-1/4" X 21'	
SGP015IMP21TC	1-1/2" X 21'	
SGP020IMP21TC	2" X 21'	
SGP025IMP21TC	2-1/2" X 21'	
SGP030IMP18TC	3" X 18'	
SGP030IMP21TC	3" X 21'	
SGP040IMP18TC	4" X 18'	
SGP040IMP21TC	4" X 21'	
SGP050IMP21TC	5" X 21'	
SGP060IMP21TC	6" X 21'	

TITAN INDUSTRIES, INC.
a world of products for the world of water

*Prices are subject to change without notice.
 Returns are subject to a restock fee.
 Special Orders are non-returnable.*

BLACK PIPE

BLACK DOMESTIC T&C		
Part No.	Description	List Price
SGP005BLK21TC	1/2" X 21'	
SGP007BLK21TC	3/4" X 21'	
SGP010BLK21TC	1" X 21'	
SGP012BLK21TC	1-1/4" X 21'	
SGP015BLK21TC	1-1/2" X 21'	
SGP020BLK21TC	2" X 21'	
SGP030BLK21TC	3" X 21'	
SGP040BLK21TC	4" X 21'	
SGP050BLK21TC	5" X 21'	
SGP060BLK21TC	6" X 21'	

BLACK IMPORT T&C		
Part No.	Description	List Price
SGP005BIM21TC	1/2" X 21'	
SGP007BIM21TC	3/4" X 21'	
SGP010BIM21TC	1" X 21'	
SGP012BIM21TC	1-1/4" X 21'	
SGP015BIM21TC	1-1/2" X 21'	
SGP020BIM21TC	2" X 21'	
SGP030BIM21TC	3" X 21'	
SGP040BIM21TC	4" X 21'	
SGP050BIM21TC	5" X 21'	
SGP060BIM21TC	6" X 21'	

Prices are subject to change without notice.

Returns are subject to a restock fee.

Special Orders are non-returnable.

TITAN INDUSTRIES, INC.
a world of products for the world of water

DROP PIPE COUPLERS & ACCESSORIES

Item	Size	Part No.	List Price	Item	Size	Part No.	List Price	
BRASS FIPT COUPLERS	1"	53-BDC100000		TORQUE ARRESTOR 1-1/4"	WITH CLAMPS	53-STA48C000		
	1-1/4"	53-BDC125000			NO CLAMPS	53-STA480000		
	2"	14-BC2000000						
GALVANIZED FIPT COUPLERS	1"	53-GDC100000		TORQUE ARRESTOR 2"	WITH CLAMPS	53-STA20C000		
	1-1/4"	53-GDC125000						
	1-1/2"	53-GDC150000						
	2"	53-GDC200000						
STAINLESS STEEL FIPT COUPLERS	1"	53-SSCPLR010		CABLE GUARD	4"-6" CASING	53-MG6000000		
	1-1/4"	53-SSCPLR012						
	1-1/2"	53-SSCPLR015			SAFETY ROPE 1/4" DIAMETER	500' ROLL	53-PUMPROPE5	
	2"	53-SSCPLR020				1000' ROLL	53-PUMPROPE1	
PVC DROP PIPE SCH 80 COUPLER	1"	53-PDPC10000		CAST IRON #625 1" - 2" DROP PIPE HOLDER		53-DP9340300		
	1-1/4"	53-PDPC12500						
	1-1/2"	53-PDPC15000			PRINSCO PIPE WRAP TAPE		39-JOINTTAPE	
2"	53-PDPC20000							
PVC EXTRA HEAVY SCH 120 COUPLER	1"	53-PDCH10000		PLASTIC WIRE TIE	4"	54-WT0400000		
	1-1/4"	53-PDCH12500			6"	54-WT0600000		
	1-1/2"	53-PDCH15000			8"	54-WT0800000		
2"	53-PDCH20000		11"		54-WT1100000			
			14"		54-WT1400000			
			17"		54-WT1700000			
			21"		54-WT2100000			

TITAN INDUSTRIES, INC.
a world of products for the world of water

*Prices are subject to change without notice.
Returns are subject to a restock fee.
Special Orders are non-returnable.*

Certa-Lok PVC DROP PIPE

Certa-Lok Drop Pipe									Certa-Lok Coupling		Certa-Lok Drop Pipe and Coupling Packaging and Weights	
SIZE	O.D.	WALL		L1 MIN	D		X	Y	BOD	L2	LAYING LENGTH	APPROX WEIGHT LB/FT (W/COUPLING)
		T1	T2		MIN	MAX						
1-1/2"	1.900	.200	.240	3.00	.100	.105	1.250	.313	2.680	4.50	20' 10'	.681 .714
2"	2.375	.218	.262	3.00	.100	.105	1.250	.313	3.200	4.50	20' 10'	.939 .981
3"	3.500	.300	.360	3.00	.100	.105	1.313	.375	4.380	4.50	20' 10'	1.895 1.960
4"	4.500	.337	.404	3.50	.125	.130	1.313	.375	5.470	5.00	20' 10'	2.775 2.877
5"	5.563	.375	.450	4.00	.125	.130	1.313	.375	6.625	5.50	20' 10'	3.858 4.009
6"	6.625	.432	.518	4.00	.125	.130	1.313	.375	7.840	6.00	20' 10'	5.321 5.544
8"	8.625	.500	.600	6.00	.135	.140	3.163	.500	10.190	10.00	20' 10'	8.351 8.960

Item	Size	Part No.	List Price
DROP PIPE	1-1/2"	33-707260000	
COUPLER	2"	33-707200000	
(INCLUDING:	3"	33-707210000	
GASKET	4"	33-707220000	
SPLINES, &	5"	33-707230000	
SCREWS)	6"	33-707240000	
	8"	33-707250000	

STAINLESS DROP PIPE	1-1/2"	33-708000000	
NIPPLE	2"	33-708010000	
CL MALE	3"	33-708020000	
X	4"	33-708030000	
MIPT	5"	33-708040000	
	6"	33-708050000	
	8"	33-708060000	

PVC DROP PIPE	1-1/2"	33-707500000	
NIPPLE	2"	33-707510000	
CL MALE	3"	33-707520000	
X	4"	33-707530000	
MIPT	5"	33-707540000	
	6"	33-707550000	
	8"	33-707560000	

Item	Size	Part No.	List Price
CERTA-LOK DROP PIPE	2"	33-708110000	
ADAPTER COUPLING	3"	33-708120000	
CERTA-LOC FEMALE X SOLVENT WELD	4"	33-708130000	

DROP PIPE	2"	33-707410000	
NIPPLE	3"	33-707420000	
CL MALE X PLAIN END	4"	33-707430000	
	8"	33-707460000	

TITAN INDUSTRIES, INC.
a world of products for the world of water

*Prices are subject to change without notice.
Returns are subject to a restock fee.
Special Orders are non-returnable.*

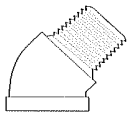
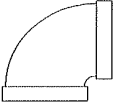
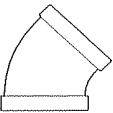
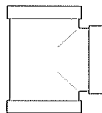
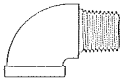

GALVANIZED FITTINGS

Item	Size	Part No.	List Price	Item	Size	Part No.	List Price
MERCHANT COUPLER 	1/8"	12-10001MC0		45° STREET ELBOW 	1/8"	12-13000145S	
	1/4"	12-10002MC0			1/4"	12-13000245S	
	3/8"	12-10003MC0			3/8"	12-13000345S	
	1/2"	12-10005MC0			1/2"	12-13000545S	
	3/4"	12-10007MC0			3/4"	12-13000745S	
	1"	12-10010MC0			1"	12-13001045S	
	1-1/4"	12-10012MC0			1-1/4"	12-13001245S	
	1-1/2"	12-10015MC0			1-1/2"	12-13001545S	
	2"	12-10020MC0			2"	12-13002045S	
	2-1/2"	12-10025MC0			2-1/2"	12-13002545S	
	3"	12-10030MC0			3"	12-13003045S	
4"	12-10040MC0		4"		12-13004045S		
6"	12-10060MC0						
90° ELBOW 	1/8"	12-11000190E			90° REDUCING ELBOW	1/2" x 3/8"	12-14050390E
	1/4"	12-11000290E		3/4" x 3/8"		12-14070390E	
	3/8"	12-11000390E		3/4" x 1/2"		12-14070590E	
	1/2"	12-11000590E		1" x 1/2"		12-14100590E	
	3/4"	12-11000790E		1-1/4" x 3/4"		12-14120790E	
	1"	12-11001090E		1-1/4" x 1"		12-14121090E	
	1-1/4"	12-11001290E		1-1/2" x 1"		12-14151090E	
	1-1/2"	12-11001590E		1-1/2" x 1-1/4"		12-14151290E	
	2"	12-11002090E		2" x 1"		12-14201090E	
	2-1/2"	12-11002590E		2" x 1-1/2"		12-14201590E	
	3"	12-11003090E					
4"	12-11004090E						
6"	12-11006090E						
45° ELBOW 	1/8"	12-12000145E		TEE 	1/8"	12-150001TEE	
	1/4"	12-12000245E			1/4"	12-150002TEE	
	3/8"	12-12000345E			3/8"	12-150003TEE	
	1/2"	12-12000545E			1/2"	12-150005TEE	
	3/4"	12-12000745E			3/4"	12-150007TEE	
	1"	12-12001045E			1"	12-150010TEE	
	1-1/4"	12-12001245E			1-1/4"	12-150012TEE	
	1-1/2"	12-12001545E			1-1/2"	12-150015TEE	
	2"	12-12002045E			2"	12-150020TEE	
	2-1/2"	12-12002545E			2-1/2"	12-150025TEE	
	3"	12-12003045E			3"	12-150030TEE	
4"	12-12004045E		4"	12-150040TEE			
6"			6"	12-150060TEE			
90° STREET ELBOW 	1/8"	12-13000190S		REDUCING TEE	3/4" x 1/2"	12-160705TEE	
	1/4"	12-13000290S			1" x 1/2"	12-161005TEE	
	3/8"	12-13000390S			1" x 3/4"	12-161007TEE	
	1/2"	12-13000590S			1" x 1-1/4"	12-161012TEE	
	3/4"	12-13000790S			1-1/4" x 1/2"	12-161205TEE	
	1"	12-13001090S			1-1/4" x 3/4"	12-161207TEE	
	1-1/4"	12-13001290S			1-1/4" x 1"	12-161210TEE	
	1-1/2"	12-13001590S			1-1/4" x 1-1/2"	12-161215TEE	
	2"	12-13002090S			1-1/2" x 3/4"	12-161507TEE	
	2-1/2"	12-13002590S			1-1/2" x 1"	12-161510TEE	
	3"	12-13003090S			1-1/2" x 1-1/4"	12-161512TEE	
4"	12-13004090S		2" x 3/4"	12-162007TEE			
			2" x 1"	12-162010TEE			

TITAN INDUSTRIES, INC.
a world of products for the world of water

Prices are subject to change without notice.
Returns are subject to a restock fee.
Special Orders are non-returnable.

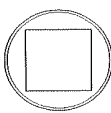
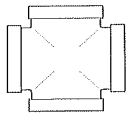
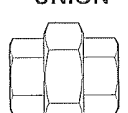
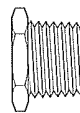
GALVANIZED FITTINGS

Item	Size	Part No.	List Price	Item	Size	Part No.	List Price
REDUCING TEE CONT.	2" x 1-1/4"	12-162012TEE		SQUARE HEAD PLUG CONT. 	1"	12-220010PLG	
	2" x 1-1/2"	12-162015TEE			1-1/4"	12-220012PLG	
	2-1/2" x 2"	12-162520TEE			1-1/2"	12-220015PLG	
	3" x 2"	12-163020TEE			2"	12-220020PLG	
	4" x 2"	12-164020TEE			2-1/2"	12-220025PLG	
CROSS 	1/4"	12-180002CRS		3"	12-220030PLG		
	1/2"	12-180005CRS		4"	12-220040PLG		
	3/4"	12-180007CRS		6"	12-220060PLG		
	1"	12-180010CRS					
	1-1/4"	12-180012CRS					
	1-1/2"	12-180015CRS					
	2"	12-180020CRS					
	2-1/2"	12-180025CRS					
UNION 	3"	12-180030CRS					
	4"	12-180040CRS					
	1/8"	12-190001UNI		HEX BUSHING 	1/4" x 1/8"	12-230201HEX	
	1/4"	12-190002UNI			3/8" x 1/8"	12-230301HEX	
	3/8"	12-190003UNI			3/8" x 1/4"	12-230302HEX	
	1/2"	12-190005UNI			1/2" x 1/8"	12-230501HEX	
	3/4"	12-190007UNI			1/2" x 1/4"	12-230502HEX	
	1"	12-190010UNI			1/2" x 3/8"	12-230503HEX	
	1-1/4"	12-190012UNI			3/4" x 1/8"	12-230701HEX	
	1-1/2"	12-190015UNI			3/4" x 1/4"	12-230702HEX	
	2"	12-190020UNI			3/4" x 3/8"	12-230703HEX	
	2-1/2"	12-190025UNI			3/4" x 1/2"	12-230705HEX	
3"	12-190030UNI		1" x 1/4"		12-231002HEX		
4"	12-190040UNI		1" x 3/8"		12-231003HEX		
CAP 	1/8"	12-200001CAP		1" x 1/2"	12-231005HEX		
	1/4"	12-200002CAP		1" x 3/4"	12-231007HEX		
	3/8"	12-200003CAP		1-1/4" x 1/8"	12-231201HEX		
	1/2"	12-200005CAP		1-1/4" x 1/4"	12-231202HEX		
	3/4"	12-200007CAP		1-1/4" x 3/8"	12-231203HEX		
	1"	12-200010CAP		1-1/4" x 1/2"	12-231205HEX		
	1-1/4"	12-200012CAP		1-1/4" x 3/4"	12-231207HEX		
	1-1/2"	12-200015CAP		1-1/4" x 1"	12-231210HEX		
	2"	12-200020CAP		1-1/2" x 1/4"	12-231502HEX		
	2-1/2"	12-200025CAP		1-1/2" x 3/8"	12-231503HEX		
	3"	12-200030CAP		1-1/2" x 1/2"	12-231505HEX		
	4"	12-200040CAP		1-1/2" x 3/4"	12-231507HEX		
6"	12-200060CAP		1-1/2" x 1"	12-231510HEX			
FLOOR FLANGE	3/4"	12-210007FLG		1-1/2" x 1-1/4"	12-231512HEX		
	1"	12-210010FLG		2" x 1/2"	12-232005HEX		
	1-1/4"	12-210012FLG		2" x 3/4"	12-232007HEX		
	1-1/2"	12-210015FLG		2" x 1"	12-232010HEX		
	2"	12-210020FLG		2" x 1-1/4"	12-232012HEX		
SQUARE HEAD PLUG	1/8"	12-220001PLG		2" x 1-1/2"	12-232015HEX		
	1/4"	12-220002PLG		2-1/2" x 1-1/4"	12-232512HEX		
	3/8"	12-220003PLG		2-1/2" x 2"	12-232520HEX		
	1/2"	12-220005PLG		3" x 1"	12-233010HEX		
	3/4"	12-220007PLG		3" x 1-1/4"	12-233012HEX		
				3" x 1-1/2"	12-233015HEX		
				3" x 2"	12-233020HEX		
				3" x 2-1/2"	12-233025HEX		
				4" x 1-1/2"	12-234015HEX		
				4" x 2"	12-234020HEX		
				4" x 2-1/2"	12-234025HEX		
				4" x 3"	12-234030HEX		
				5" x 3"	12-235030HEX		
				5" x 4"	12-235040HEX		
				6" x 4"	12-236040HEX		
				8" x 6"	12-238060HEX		



Prices are subject to change without notice.

Returns are subject to a restock fee.

Special Orders are non-returnable.

TITAN INDUSTRIES, INC.
a world of products for the world of water

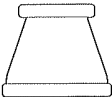
GALVANIZED FITTINGS

Item	Size	Part No.	List Price	Item	Size	Part No.	List Price
BELL REDUCER 	1/4" x 1/8"	12-240201BEL		NIPPLE CONT. 	1/4" x 6"	12-2502060NP	
	3/8" x 1/4"	12-240302BEL			1/4" x 8"	12-2502080NP	
	1/2" x 1/8"	12-240501BEL			1/4" x 10"	12-2502100NP	
	1/2" x 1/4"	12-240502BEL			1/4" x 12"	12-2502120NP	
	1/2" x 3/8"	12-240503BEL			3/8" x CL	12-2503000NP	
	3/4" x 1/4"	12-240702BEL			3/8" x 1-1/2"	12-2503015NP	
	3/4" x 3/8"	12-240703BEL			3/8" x 2"	12-2503020NP	
	3/4" x 1/2"	12-240705BEL			3/8" x 2-1/2"	12-2503025NP	
	1" x 1/4"	12-241002BEL			3/8" x 3"	12-2503030NP	
	1" x 3/8"	12-241003BEL			3/8" x 3-1/2"	12-2503035NP	
	1" x 1/2"	12-241005BEL			3/8" x 4"	12-2503040NP	
	1" x 3/4"	12-241007BEL			3/8" x 4-1/2"	12-2503045NP	
	1-1/4" x 1/2"	12-241205BEL			3/8" x 5"	12-2503050NP	
	1-1/4" x 3/4"	12-241207BEL			3/8" x 5-1/2"	12-2503055NP	
	1-1/4" x 1"	12-241210BEL			3/8" x 6"	12-2503060NP	
	1-1/2" x 3/8"	12-241503BEL			3/8" x 8"	12-2503080NP	
	1-1/2" x 1/2"	12-241505BEL			3/8" x 10"	12-2503100NP	
	1-1/2" x 3/4"	12-241507BEL			3/8" x 12"	12-2503120NP	
	1-1/2" x 1"	12-241510BEL			1/2" x CL	12-2505000NP	
	1-1/2" x 1-1/4"	12-241512BEL			1/2" x 1-1/2"	12-2505015NP	
	2" x 1/2"	12-242005BEL			1/2" x 2"	12-2505020NP	
	2" x 3/4"	12-242007BEL			1/2" x 2-1/2"	12-2505025NP	
	2" x 1"	12-242010BEL			1/2" x 3"	12-2505030NP	
	2" x 1-1/4"	12-242012BEL			1/2" x 3-1/2"	12-2505035NP	
	2" x 1-1/2"	12-242015BEL			1/2" x 4"	12-2505040NP	
	2-1/2" x 2"	12-242520BEL			1/2" x 4-1/2"	12-2505045NP	
	3" x 1-1/4"	12-243012BEL			1/2" x 5"	12-2505050NP	
	3" x 1-1/2"	12-243015BEL			1/2" x 5-1/2"	12-2505055NP	
3" x 2"	12-243020BEL		1/2" x 6"	12-2505060NP			
3" x 2-1/2"	12-243025BEL		1/2" x 8"	12-2505080NP			
4" x 2"	12-244020BEL		1/2" x 10"	12-2505100NP			
4" x 3"	12-244030BEL		1/2" x 12"	12-2505120NP			
6" x 4"	12-246040BEL		3/4" x CL	12-2507000NP			
NIPPLE 	1/8" x CL	12-2501000NP		3/4" x 1-1/2"	12-2507015NP		
	1/8" x 1-1/2"	12-2501005NP		3/4" x 2"	12-2507020NP		
	1/8" x 2"	12-2501020NP		3/4" x 2-1/2"	12-2507025NP		
	1/8" x 2-1/2"	12-2501025NP		3/4" x 3"	12-2507030NP		
	1/8" x 3"	12-2501030NP		3/4" x 3-1/2"	12-2507035NP		
	1/8" x 3-1/2"	12-2501035NP		3/4" x 4"	12-2507040NP		
	1/8" x 4"	12-2501040NP		3/4" x 4-1/2"	12-2507045NP		
	1/8" x 4-1/2"	12-2501045NP		3/4" x 5"	12-2507050NP		
	1/8" x 5"	12-2501050NP		3/4" x 5-1/2"	12-2507055NP		
	1/8" x 5-1/2"	12-2501055NP		3/4" x 6"	12-2507060NP		
	1/8" x 6"	12-2501060NP		3/4" x 8"	12-2507080NP		
	1/4" x CL	12-2502000NP		3/4" x 10"	12-2507100NP		
	1/4" x 1-1/2"	12-2502005NP		3/4" x 12"	12-2507120NP		
	1/4" x 2"	12-2502020NP		3/4" x 24"	12-2507210NP		
	1/4" x 2-1/2"	12-2502025NP		3/4" x 36"	12-2507360NP		
	1/4" x 3"	12-2502030NP		1" x CL	12-2510000NP		
	1/4" x 3-1/2"	12-2502035NP		1" x 2"	12-2510020NP		
	1/4" x 4"	12-2502040NP		1" x 2-1/2"	12-2510025NP		
	1/4" x 4-1/2"	12-2502045NP		1" x 3"	12-2510030NP		
	1/4" x 5"	12-2502050NP		1" x 3-1/2"	12-2510035NP		
	1/4" x 5-1/2"	12-2502055NP		1" x 4"	12-2510040NP		
				1" x 4-1/2"	12-2510045NP		

TITAN INDUSTRIES, INC.
a world of products for the world of water

Prices are subject to change without notice.

Returns are subject to a restock fee.

Special Orders are non-returnable.

BLACK FITTINGS

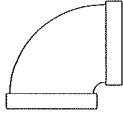
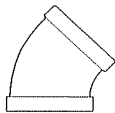
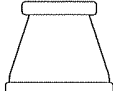
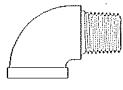
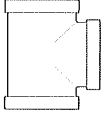
Item	Size	Part No.	List Price	Item	Size	Part No.	List Price
MERCHANT COUPLER 	1/8"	13-100001MCO		REDUCING TEE	1/2"X1/2"X3/4"	13-160507TEE	
	1/4"	13-100002MCO			3/4"X3/4"X1/2"	13-160705TEE	
	3/8"	13-100003MCO			3/4"X3/4"X1"	13-160710TEE	
	1/2"	13-100005MCO			1"X1"X1/2"	13-161005TEE	
	3/4"	13-100007MCO			1"X1"X3/4"	13-161007TEE	
	1"	13-100010MCO			1-1/4"X1-1/4"X1/2"	13-161205TEE	
	1-1/4"	13-100012MCO			1-1/4"X1-1/4"X3/4"	13-161207TEE	
	1-1/2"	13-100015MCO			1-1/4"X1-1/4"X1"	13-161210TEE	
	2"	13-100020MCO			1-1/2"X1-1/2"X1/2"	13-161505TEE	
	2-1/2"	13-100025MCO			1-1/2"X1-1/2"X3/4"	13-161507TEE	
	3"	13-100030MCO			1-1/2"X1-1/2"X1"	13-161510TEE	
	4"	13-100040MCO			1-1/2"X1-1/2"X1-1/4"	13-161512TEE	
	5"	13-100050MCO			2"X2"X1/2"	13-162005TEE	
6"	13-100060MCO		2"X2"X3/4"	13-162007TEE			
				2"X2"X1"	13-162010TEE		
				2"X2"X1-1/4"	13-162012TEE		
				2"X2"X1-1/2"	13-162015TEE		
90° ELBOW 	1/4"	13-11000290E		REDUCING TEE (ON THE RUN)	3/4"X1/2"X1/2"	13-16070505T	
	3/8"	13-11000390E			3/4"X1/2"X3/4"	13-16070507T	
	1/2"	13-11000590E			1"X1/2"X1/2"	13-161005TEE	
	3/4"	13-11000790E			1"X1/2"X3/4"	13-16100507T	
	1"	13-11001090E			1"X1/2"X1"	13-16100510T	
	1-1/4"	13-11001290E			1"X3/4"X1/2"	13-16100705T	
	1-1/2"	13-11001590E			1"X3/4"X3/4"	13-161007TEE	
	2"	13-11002090E			1"X3/4"X1"	13-16100710T	
	3"	13-11003090E			1-1/4"X1"X1"	13-16121010T	
	4"	13-11004090E			1-1/4"X1"X1-1/4"	13-16121012T	
6"	13-11006090E						
45° ELBOW 	1/4"	13-12000245E		BELL REDUCER 	3/8"X1/4"	13-170302CUP	
	1/2"	13-12000545E			1/2"X1/4"	13-170502CUP	
	3/4"	13-12000745E			1/2"X3/8"	13-170503CUP	
	1"	13-12001045E			3/4"X1/2"	13-170705CUP	
	2"	13-12002045E			1"X1/2"	13-171005CUP	
	3"	13-12003045E			1"X3/4"	13-171007CUP	
90° STREET ELBOW 	1/4"	13-13000290S		1-1/4"X1/2"	13-171205CUP		
	3/8"	13-13000390S		1-1/4"X3/4"	13-171207CUP		
	1/2"	13-13000590S		1-1/4"X1"	13-171210CUP		
	3/4"	13-13000790S		1-1/2"X1/2"	13-171505CUP		
	1"	13-13001090S		1-1/2"X3/4"	13-171507CUP		
	1-1/4"	13-13001290S		1-1/2"X1"	13-171510CUP		
	1-1/2"	13-13001590S		1-1/2"X1-1/4"	13-171512CUP		
	2"	13-13002090S		2"X1/2"	13-172005CUP		
3"	13-13003090S		2"X3/4"	13-172007CUP			
TEE 	1/4"	13-150002TEE		2"X1"	13-172010CUP		
	3/8"	13-150003TEE		2"X1-1/4"	13-172012CUP		
	1/2"	13-150005TEE		2"X1-1/2"	13-172015CUP		
	3/4"	13-150007TEE		3"X2"	13-173020CUP		
	1"	13-150010TEE		4"X3"	13-174030CUP		
	1-1/4"	13-150012TEE					
	1-1/2"	13-150015TEE					
	2"	13-150020TEE					
	3"	13-150030TEE					
	4"	13-150040TEE					



TITAN INDUSTRIES, INC.
a world of products for the world of water

Prices are subject to change without notice.

Returns are subject to a restock fee.

Special Orders are non-returnable.

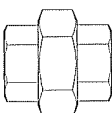
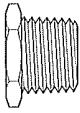
BLACK FITTINGS

Item	Size	Part No.	List Price	Item	Size	Part No.	List Price
UNION 	1/8"	13-190001UNI		HEX BUSHING CONT. 	2"X3/4"	13-232007HEX	
	1/4"	13-190002UNI			2"X1-1/4"	13-232012HEX	
	3/8"	13-190003UNI			2"X1-1/2"	13-232015HEX	
	1/2"	13-190005UNI			2-1/2"X1-1/4"	13-232512HEX	
	3/4"	13-190007UNI			2-1/2"X2"	13-232520HEX	
	1"	13-190010UNI			3"X1-1/2"	13-233015HEX	
	1-1/4"	13-190012UNI			3"X2"	13-233020HEX	
	1-1/2"	13-190015UNI			4"X2"	13-234020HEX	
	2"	13-190020UNI			4"X2-1/2"	13-234025HEX	
	3"	13-190030UNI			4"X3"	13-234030HEX	
4"	13-190040UNI		5"X4"	13-235040HEX			
6"	13-190050UNI		6"X4"	13-236040HEX			
6"X5"	13-236050HEX						
CAP 	1/8"	13-200001CAP		NIPPLE 	1/8"X1-1/2"	13-2501015NP	
	1/4"	13-200002CAP			1/8"X2-1/2"	13-2501025NP	
	3/8"	13-200003CAP			1/8"X3"	13-2501030NP	
	1/2"	13-200005CAP			1/8"X3-1/2"	13-2501035NP	
	3/4"	13-200007CAP			1/8"X4"	13-2501040NP	
	1"	13-200010CAP			1/8"X4-1/2"	13-2501045NP	
	1-1/4"	13-200012CAP			1/8"X5-1/2"	13-2501055NP	
	1-1/2"	13-200015CAP			1/8"X6"	13-2501060NP	
	2"	13-200020CAP			1/4"X1-1/2"	13-2502015NP	
	2-1/2"	13-200025CAP			1/4"X2"	13-2502020NP	
3"	13-200030CAP		1/4"X2-1/2"	13-2502025NP			
4"	13-200040CAP		1/4"X3"	13-2502030NP			
6"	13-200060CAP		1/4"X3-1/2"	13-2502035NP			
1/4"X4"	13-2502040NP		1/4"X4"	13-2502040NP			
1/4"X4-1/2"	13-2502045NP		1/4"X4-1/2"	13-2502045NP			
1/4"X5"	13-2502050NP		1/4"X5"	13-2502050NP			
1/4"X6"	13-2502060NP		1/4"X6"	13-2502060NP			
3/8"XCL	13-2503000NP		3/8"XCL	13-2503000NP			
3/8"X1-1/2"	13-2503015NP		3/8"X1-1/2"	13-2503015NP			
3/8"X2"	13-2503020NP		3/8"X2"	13-2503020NP			
3/8"X2-1/2"	13-2503025NP		3/8"X2-1/2"	13-2503025NP			
3/8"X3"	13-2503030NP		3/8"X3"	13-2503030NP			
3/8"X3-1/2"	13-2503035NP		3/8"X3-1/2"	13-2503035NP			
3/8"X4"	13-2503040NP		3/8"X4"	13-2503040NP			
3/8"X4-1/2"	13-2503045NP		3/8"X4-1/2"	13-2503045NP			
3/8"X5"	13-2503050NP		3/8"X5"	13-2503050NP			
3/8"X5-1/2"	13-2503055NP		3/8"X5-1/2"	13-2503055NP			
3/8"X6"	13-2503060NP		3/8"X6"	13-2503060NP			
1/2"XCL	13-2505000NP		1/2"XCL	13-2505000NP			
1/2"X1-1/2"	13-2505015NP		1/2"X1-1/2"	13-2505015NP			
1/2"X2"	13-2505020NP		1/2"X2"	13-2505020NP			
1/2"X2-1/2"	13-2505025NP		1/2"X2-1/2"	13-2505025NP			
1/2"X3"	13-2505030NP		1/2"X3"	13-2505030NP			
1/2"X3-1/2"	13-2505035NP		1/2"X3-1/2"	13-2505035NP			
1/2"X4"	13-2505040NP		1/2"X4"	13-2505040NP			
1/2"X4-1/2"	13-2505045NP		1/2"X4-1/2"	13-2505045NP			
1/2"X5"	13-2505050NP		1/2"X5"	13-2505050NP			
1/2"X5-1/2"	13-2505055NP		1/2"X5-1/2"	13-2505055NP			
1/2"X6"	13-2505060NP		1/2"X6"	13-2505060NP			
1/2"X8"	13-2505080NP		1/2"X8"	13-2505080NP			
1/2"X10"	13-2505100NP		1/2"X10"	13-2505100NP			
1/4"X1/8"	13-230201HEX						
3/8"X1/4"	13-230302HEX						
1/2"X1/4"	13-230502HEX						
1/2"X3/8"	13-230503HEX						
3/4"X1/4"	13-230702HEX						
3/4"X1/2"	13-230705HEX						
1"X1/2"	13-231005HEX						
1"X3/4"	13-231007HEX						
1-1/4"X1/2"	13-231205HEX						
1-1/4"X3/4"	13-231207HEX						
1-1/4"X1"	13-231210HEX						
1-1/2"X1/2"	13-231505HEX						
1-1/2"X3/4"	13-231507HEX						
1-1/2"X1"	13-231510HEX						
1-1/2"X1-1/4"	13-231512HEX						
2"X1/2"	13-232005HEX						



TITAN INDUSTRIES, INC.
a world of products for the world of water

Prices are subject to change without notice.

Returns are subject to a restock fee.

Special Orders are non-returnable.

BLACK FITTINGS

Item	Size	Part No.	List Price	Item	Size	Part No.	List Price
NIPPLE CONT. 	1/2"X12"	13-2505120NP		NIPPLE CONT. 	1-1/4"X10"	13-2512100NP	
	1/2"X18"	13-2505180NP			1-1/4"X12"	13-2512120NP	
	1/2"X24"	13-2505240NP			1-1/2"XCL	13-2515000NP	
	1/2"X30"	13-2505300NP			1-1/2"X2"	13-2515050NP	
	1/2"X36"	13-2505360NP			1-1/2"X2-1/2"	13-2515025NP	
	1/2"X48"	13-2505480NP			1-1/2"X3"	13-2515030NP	
	1/2"X60"	13-2505600NP			1-1/2"X3-1/2"	13-2515035NP	
	3/4"XCL	13-2507000NP			1-1/2"X4"	13-2515040NP	
	3/4"X1-1/2"	13-2507015NP			1-1/2"X4-1/2"	13-2515045NP	
	3/4"X2"	13-2507020NP			1-1/2"X5"	13-2515050NP	
	3/4"X2-1/2"	13-2507025NP			1-1/2"X5-1/2"	13-2515055NP	
	3/4"X3"	13-2507030NP			1-1/2"X6"	13-2515060NP	
	3/4"X4"	13-2507040NP			2"XCL	13-2520000NP	
	3/4"X3-1/2"	13-2507035NP			2"X2-1/2"	13-2520025NP	
	3/4"X4-1/2"	13-2507045NP			2"X3"	13-2520030NP	
	3/4"X5"	13-2507050NP			2"X4"	13-2520040NP	
	3/4"X6"	13-2507060NP			2"X5"	13-2520050NP	
	3/4"X8"	13-2507080NP			2"X5-1/2"	13-2520055NP	
	3/4"X10"	13-2507100NP			2"X6"	13-2520060NP	
	3/4"X12"	13-2507120NP			2"X8"	13-2520080NP	
	3/4"X18"	13-2507180NP			2"X12"	13-252012NP	
	3/4"X24"	13-2507240NP			2-1/2"X6"	13-2525060NP	
	3/4"X30"	13-2507300NP			3"X3"	13-2530030NP	
	3/4"X36"	13-2507360NP			3"X6"	13-2530060NP	
	3/4"X48"	13-2507480NP			3"X8"	13-2530080NP	
	3/4"X60"	13-2507600NP			3"X4"	13-2530400NP	
	1"XCL	13-2510000NP			4"X4"	13-2540040NP	
	1"X2"	13-2510020NP			4"X8"	13-2540080NP	
	1"X2-1/2"	13-2510025NP			4"X12"	13-2540120NP	
	1"X3"	13-2510030NP			5"X6"	13-2550060NP	
	1"X3-1/2"	13-2510035NP			6"X6"	13-2560060NP	
	1"X4"	13-2510040NP			6"X18"	13-2560180NP	
	1"X4-1/2"	13-2510045NP					
	1"X5"	13-2510050NP					
	1"X5-1/2"	13-2510055NP					
	1"X6"	13-2510060NP					
	1"X8"	13-2510080NP					
	1"X10"	13-2510100NP					
	1"X12"	13-2510120NP					
	1"X18"	13-2510180NP					
	1"X24"	13-2510240NP					
	1"X30"	13-2510300NP					
	1"X36"	13-2510360NP					
	1"X48"	13-2510480NP					
	1"X60"	13-2510600NP					
1-1/4"XCL	13-2512000NP						
1-1/4"X2"	13-2512020NP						
1-1/4"X2-1/2"	13-2512025NP						
1-1/4"X3"	13-2512030NP						
1-1/4"X3-1/2"	13-2512035NP						
1-1/4"X4"	13-2512040NP						
1-1/4"X5"	13-2512050NP						
1-1/4"X5-1/2"	13-2512055NP						
1-1/4"X6"	13-2512060NP						
1-1/4"X8"	13-2512080NP						
				WELD-ON NIPPLE	2" 3" 4" 5" 6" 8"	13-2702NPWLD 13-2703NPWLD 13-2704NPWLD 13-2705NPWLD 13-2706NPWLD 13-2708NPWLD	

TITAN INDUSTRIES, INC.
a world of products for the world of water

Prices are subject to change without notice.
 Returns are subject to a restock fee.
 Special Orders are non-returnable.

NOTES

CALL US TODAY!

PO Box 308
East Hwy 30
Paxton, Nebraska 69155
800-658-4086
308-239-4281
308-239-4474 (fax)

11555 S. Highway 283
Dodge City, Kansas 67801
800-658-4078
620-225-6201
620-225-1171 (fax)

1203 S.E. Grand Blvd.
Oklahoma, City, Oklahoma 73129
800-749-8659
405-677-1290
405-677-1296 (fax)

112 Grant - Aurora Industrial Park
Aurora, Nebraska 68818
800-255-4188
402-694-4188
402-694-4511 (fax)

1912 West Harry
Wichita, Kansas 67213
866-323-9111
316-262-9111
316-262-9119 (fax)

TITAN INDUSTRIES, INC.
a world of products for the world of water

IPS PIPE DIMENSIONS

Part No.	Size - SDR/Schedule	PSI	Wall	O.D.	I.D.	Wt./Ft.
PVC005C20020B	1/2" SDR 21 BE	200	.040	.840	.760	.098
PVC005SC4020B	1/2" Sch 40 BE	600	.109	.840	.622	.167
PVC005SC8020P	1/2" Sch 80 PE	850	.147	.840	.546	.220
PVC007C20020B	3/4" SDR 21 BE	200	.060	1.050	.930	.126
PVC007SC4020B	3/4" Sch 40 BE	480	.113	1.050	.824	.218
PVC007SC8020P	3/4" Sch 80 PE	680	.154	1.050	.742	.283
TBE007SC8020T	3/4" Sch 80 TBE	680	.154	1.050	.742	.283
PVC010C20020B	1" SDR 21 BE	200	.063	1.315	1.189	.165
PVC010SC4020B	1" Sch 40 BE	450	.133	1.315	1.049	.324
PVC010SC8020P	1" Sch 80 PE	630	.179	1.315	.957	.420
TBE010SC8020T	1" Sch 80 TBE	630	.179	1.315	.957	.420
PVC012C12520B	1-1/4" SDR 32.5 BE	125	.051	1.660	1.558	.180
PVC012C16020B	1-1/4" SDR 26 BE	160	.064	1.660	1.532	.225
PVC012C20020B	1-1/4" SDR 21 BE	200	.079	1.660	1.502	.258
PVC012SC4020B	1-1/4" Sch 40 BE	370	.140	1.660	1.380	.438
PVC012SC8020P	1-1/4" Sch 80 PE	520	.191	1.660	1.278	.577
TBE012SC8020T	1-1/4" Sch 80 TBE	520	.191	1.660	1.278	.577
PVC015C12520B	1-1/2" SDR 32.5 BE	125	.058	1.900	1.784	.224
PVC015C16020B	1-1/2" SDR 26 BE	160	.073	1.900	1.754	.280
PVC015C20020B	1-1/2" SDR 21 BE	200	.090	1.900	1.720	.338
PVC015SC4020B	1-1/2" Sch 40 BE	330	.145	1.900	1.610	.524
PVC015SC8020P	1-1/2" Sch 80 PE	470	.200	1.900	1.500	.699
TBE015SC8020T	1-1/2" Sch 80 TBE	470	.200	1.900	1.500	.699
PVC020C10020B	2" SDR 41 BE	100	.058	2.375	2.259	.327
PVC020C12520B	2" SDR 32.5 BE	125	.073	2.375	2.229	.354
PVC020C16020B	2" SDR 26 BE	160	.091	2.375	2.193	.442
PVC020C20020B	2" SDR 21 BE	200	.113	2.375	2.149	.537
PVC020SC4020B	2" Sch 40 BE	280	.154	2.375	2.067	.703
PVC020SC8020P	2" Sch 80 PE	400	.218	2.375	1.939	.965
PVC020SC8020B	2" Sch 80 BE	400	.218	2.375	1.939	.965
TBE020SC8020T	2" Sch 80 TBE	400	.218	2.375	1.939	.965
PVC025C16020B	2-1/2" SDR 26 BE	160	.110	2.875	2.655	.628
PVC025C20020B	2-1/2" SDR 21 BE	200	.163	2.875	2.549	.761
PVC025SC4020B	2-1/2" Sch 40 BE	300	.203	2.875	2.469	1.103
PVC025SC8020P	2-1/2" Sch 80 PE	420	.276	2.875	2.323	1.450
TBE025SC8020T	2-1/2" Sch 80 TBE	420	.276	2.875	2.323	1.450
PVC030C16020B	3" SDR 26 BE	160	.135	3.500	3.230	.955
PVC030C20020B	3" SDR 21 BE	200	.167	3.500	3.166	1.141
PVC030SC4020B	3" Sch 40 BE	260	.216	3.500	3.068	1.458
PVC030SC8020P	3" Sch 80 PE	370	.300	3.500	2.900	1.956
TBE030SC8020T	3" Sch 80 TBE	370	.300	3.500	2.900	1.956
PVC040C16020B	4" SDR 26 BE	160	.173	4.500	4.154	1.550
PVC040C20020B	4" SDR 21 BE	200	.214	4.500	4.072	1.878
PVC040SC4020B	4" Sch 40 BE	220	.237	4.500	4.026	2.071
PVC040SC8020P	4" Sch 80 PE	320	.337	4.500	3.826	2.860
PVC040SC8020B	4" Sch 80 BE	320	.337	4.500	3.826	2.860

Prices are subject to change without notice.

Returns are subject to a restock fee.

Special Orders are non-returnable.

TITAN INDUSTRIES, INC.
a world of products for the world of water

IPS PIPE DIMENSIONS

Part No.	Size - SDR/Schedule	PSI	Wall	O.D.	I.D.	Wt./Ft.
TBE040SC8020T	4" Sch 80 TBE	320	.337	4.500	3.826	2.860
PVC045C16020B	4-1/2" SDR 26 BE	160	.190	4.950	4.570	1.865
PVC045SC4020B	4-1/2" Sch 40 BE	205	.248	4.950	4.454	2.384
PVC045SD1720B	4-1/2" SDR 17 BE	250	.291	4.950	4.368	2.790
PVC050C16020B	5" SDR 26 BE	160	.214	5.563	5.135	2.355
PVC050SC4020B	5" Sch 40 BE	190	.258	5.563	5.047	2.765
PVC050C20020B	5" SDR 21 BE	200	.265	5.563	5.033	2.870
PVC050SD1720B	5" SDR 17 BE	250	.327	5.563	4.909	3.540
PVC050SC8020P	5" Sch 80 PE	290	.375	5.563	4.813	3.940
PVC050SC8020B	5" Sch 80 BE	290	.375	5.563	4.813	3.940
PVC060C16020B	6" SDR 26 BE	160	.255	6.625	6.115	3.320
PVC060SC4020B	6" Sch 40 BE	180	.280	6.625	6.065	3.680
PVC060C20020B	6" SDR 21 BE	200	.316	6.625	5.993	4.060
PVC060SD1720B	6" SDR 17 BE	250	.390	6.625	5.825	5.050
PVC060SC8020P	6" Sch 80 PE	280	.432	6.625	5.761	5.450
PVC060SC8020B	6" Sch 80 BE	280	.432	6.625	5.761	5.450
PVC069C15020B	6.9" SDR 27.6	150	.250	6.900	6.400	3.443
PVC069C20020B	6.9" SDR 21 BE	200	.329	6.900	6.242	4.360
PVC069C25020B	6.9" SDR 17 BE	250	.406	6.900	6.088	5.453
PVC080SC4020B	8" Sch 40 BE	160	.322	8.625	7.981	5.541
PVC080C16020B	8" SDR 26 BE	160	.332	8.625	7.961	5.594
PVC080C20020B	8" SDR 21 BE	200	.411	8.625	7.803	6.860
PVC080SC8020P	8" Sch 80 PE	250	.500	8.625	7.625	8.025
PVC080SC8020B	8" Sch 80 BE	250	.500	8.625	7.625	8.025
PVC100SC4020B	10" Sch 40 BE	140	.365	10.750	10.020	7.800
PVC100C16020B	10" SDR 26 BE	160	.413	10.750	9.924	9.030
PVC100C20020B	10" SDR 21 BE	200	.511	10.750	9.728	11.040
PVC100SC8020B	10" Sch 80 BE	230	.593	10.750	9.561	12.230
PVC120SC4020B	12" Sch 40 BE	130	.420	12.750	11.910	10.310
PVC120C16020B	12" SDR 26 BE	160	.490	12.750	11.770	12.710
PVC120C20020B	12" SDR 21 BE	200	.606	12.750	11.538	15.497
PVC120SC8020B	12" Sch 80 BE	230	.687	12.750	11.376	17.051
PVC140SC4020B	14" Sch 40 BE	130	.438	14.000	13.124	12.180
PVC140SC8020B	14" Sch 80 BE	220	.750	14.000	12.500	20.340
PVC160SC4020B	16" Sch 40 BE	120	.500	16.000	15.000	16.150
PVC160C16020B	16" SDR 26 BE	160	.616	16.000	14.768	19.750
PVC160C20020B	16" SDR 21 BE	200	.760	16.000	14.480	23.760
PVC160SC8020B	16" Sch 80 BE	220	.843	16.000	14.314	26.030
PVC180SC4020B	18" Sch 40 BE	120	.562	18.000	16.876	20.11
PVC180SC8020B	18" Sch 80 BE	220	.937	18.000	16.126	32.76
PVC200SC4020B	20" Sch 40 BE	120	.593	20.000	18.814	23.62
PVC200SC8020B	20" Sch 80 BE	220	1.031	20.000	17.938	40.09
PVC240SC4020B	24" Sch 40 BE	120	.687	24.000	22.626	32.87
PVC240SC8020B	24" Sch 80 BE	220	1.218	24.000	21.564	56.88

Prices are subject to change without notice.

Returns are subject to a restock fee.

Special Orders are non-returnable.

TITAN INDUSTRIES, INC.
a world of products for the world of water

SEWER & DRAIN PIPE (PVC) DIMENSIONS

Part No.	Description	Available	Wall	O.D.	I.D.	Wt./Ft.
CPVC005SC4010	1/2" CPVC - 10'	Plain End	.068	.625	.489	.084
CPVC007SC4010	3/4" CPVC - 10'	Plain End	.080	.875	.715	.142
DPVC012SC4020	1-1/4" Sch 40 DWV	Plain End	.140	1.660	1.380	.438
DPVC015SC4020	1-1/2" Sch 40 DWV	Plain End	.145	1.900	1.610	.524
CEL015SC4020P	1-1/2" Sch 40 Cell Core	Plain End	.145	1.900	1.610	.410
DPVC020SC4020	2" Sch 40 DWV	Plain End	.154	2.375	2.067	.703
CEL020SC4020P	2" Sch 40 Cell Core	Plain End	.154	2.375	2.067	.530
SEWS03272910B	3" Type 2729 - 10'	Belled End	.070	3.250	3.110	.466
DPVC030SC4020	3" Sch 40 DWV	Plain End	.216	3.500	3.068	1.473
CEL030SC4020P	3" Sch 40 Cell Core	Plain End	.216	3.500	3.068	1.100
SEWS04272910B	4" Type 2729 - 10'	Belled End	.075	4.215	4.065	.651
SEWP04272910B	4" Type 2729 - 10' PERF	Belled End	.075	4.215	4.065	.651
SEWS04SD3510B	4" SDR 35 (#3034)	Belled End	.120	4.215	3.975	.986
SEWS04SD3513G	4" SDR 35 x 13'/14'	Gasket End	.120	4.215	3.975	.986
SEWS04SD3520G	4" SDR 35 x 20'	Gasket End	.120	4.215	3.975	.986
SEWS040SD2620B	4" SDR 26 x 10/20'	Belled End	.162	4.215	3.891	1.390
SEWS040SD2613G	4" SDR 26 x 13'/14'	Gasket End	.162	4.215	3.891	1.390
DPVC040SC4020	4" Sch 40 DWV	Plain End	.237	4.500	4.026	2.071
CEL060SC4020P	4" Sch 40 Cell Core	Plain End	.237	4.500	4.026	1.610
SEWS06272910B	6" Type 2729 - 10'	Belled End	.100	6.275	6.075	1.268
SEWS06SD3510B	6" SDR 35 (#3034)	Belled End	.180	6.275	5.915	2.270
SEWP06SD3510B	6" SDR 35 (#3034) PERF	Belled End	.180	6.275	5.915	2.270
SEWS06SD3513G	6" SDR 35 x 13'/14'	Gasket End	.180	6.275	5.915	2.270
SEWS06SD3520G	6" SDR 35 x 20'	Gasket End	.180	6.275	5.915	2.270
SEWS060SD2620B	6" SDR 26 x 10/20'	Belled End	.241	6.275	5.793	3.040
SEWS060SD2613G	6" SDR 26 x 13'/14'	Gasket End	.241	6.275	5.793	3.040
DPVC060SC4020	6" Sch 40 DWV	Plain End	.280	6.625	6.065	3.680
CEL060SC4020P	6" Sch 40 Cell Core	Plain End	.280	6.625	6.065	2.830
SEWS08SD3510B	8" SDR 35 (#3034)	Belled End	.240	8.400	7.920	4.080
SEWS08SD3513G	8" SDR 35 x 13'/14'	Gasket End	.240	8.400	7.920	4.080
SEWS08SD3520G	8" SDR 35 x 20'	Gasket End	.240	8.400	7.920	4.080
SEWS080SD2620B	8" SDR 26 x 10/20'	Belled End	.323	8.400	7.754	5.430
SEWS08SD2613G	8" SDR 26 x 13'/14'	Gasket End	.323	8.400	7.754	5.430
DPVC080SC4020	8" Sch 40 DWV	Plain End	.322	8.625	7.981	5.541
SEWS10SD3513G	10" SDR 35 x 13'/14'	Gasket End	.300	10.500	9.600	6.360
SEWS10SD3520G	10" SDR 35 x 20'	Gasket End	.300	10.500	9.600	6.360
SEWS10SD2613G	10" SDR 26 x 13'/14'	Gasket End	.404	10.500	9.692	8.492
DPVC100SC4020	10" Sch 40 DWV	Plain End	.365	10.750	10.020	7.800
SEWS12SD3513G	12" SDR 35 x 13'/14'	Gasket End	.360	12.500	11.780	9.110
SEWS12SD3520G	12" SDR 35 x 20'	Gasket End	.360	12.500	11.780	9.110
SEWS12SD2613G	12" SDR 26 x 13'/14'	Gasket End	.481	12.500	11.538	12.030
DPVC120SC4020	12" Sch 40 DWV	Plain End	.420	12.750	11.910	11.910

Prices are subject to change without notice.

Returns are subject to a restock fee.

Special Orders are non-returnable.

TITAN INDUSTRIES, INC.
a world of products for the world of water

SEWER & DRAIN PIPE (PVC) DIMENSIONS

Part No.	Description	Available	Wall	O.D.	I.D.	Wt./Ft.
SEWS15SD3513G	15" SDR 35 x 13'/14'	Gasket End	.437	15.300	14.426	13.480
SEWS15SD3520G	15" SDR 35 x 20'	Gasket End	.437	15.300	14.426	13.480
SEWS15SD2613G	15" SDR 26 x 13'/14'	Gasket End	.588	15.300	14.124	18.420
SEWS18SD3513G	18" SDR 35 x 13'/14'	Gasket End	.536	18.701	17.629	22.480
SEWS18SD2613G	18" SDR 26 x 13'/14'	Gasket End	.719	18.701	17.263	28.545
SEWS21SD3513G	21" SDR 35 x 13'/14'	Gasket End	.632	22.047	20.783	30.261
SEWS21SD2613G	21" SDR 26 x 13'/14'	Gasket End	.899	22.047	20.249	42.476
SEWS24SD3513G	24" SDR 35 x 13'/14'	Gasket End	.711	24.803	23.381	38.642
SEWS24SD2613G	24" SDR 26 x 13'/14'	Gasket End	.954	24.803	22.895	51.294
SEWS27SD3513G	27" SDR 35 x 13'/14'	Gasket End	.801	27.953	26.351	49.208
SEWS30SD3513G	30" SDR 35 x 13'/14'	Gasket End	.914	32.000	30.172	64.099

GASKET END IPS PIPE DIMENSIONS

Part No.	SDR/Schedule	PSI	Wall	O.D.	I.D.	Wt./Ft.
PVC015C16020G	1-1/2" SDR 26 GE	160	.073	1.900	1.754	.280
PVC015C20020G	1-1/2" SDR 21 GE	200	.090	1.900	1.720	.338
PVC020C16020G	2" SDR 26 GE	160	.091	2.375	2.193	.442
PVC020C20020G	2" SDR 21 GE	200	.113	2.375	2.149	.537
PVC025C16020G	2-1/2" SDR 26 GE	160	.110	2.875	2.655	.628
PVC025C20020G	2-1/2" SDR 21 GE	200	.163	2.875	2.549	.761
PVC030C16020G	3" SDR 26 GE	160	.135	3.500	3.230	.955
PVC030C20020G	3" SDR 21 GE	200	.167	3.500	3.166	1.141
PVC040C16020G	4" SDR 26 GE	160	.173	4.500	4.154	1.550
PVC040C20020G	4" SDR 21 GE	200	.214	4.500	4.072	1.878
PVC060C16020G	6" SDR 26 GE	160	.255	6.625	6.115	3.320
PVC060C20020G	6" SDR 21 GE	200	.316	6.625	5.993	4.060
PVC080C16020G	8" SDR 26 GE	160	.332	8.625	7.961	5.594
PVC080C20020G	8" SDR 21 GE	200	.411	8.625	7.803	6.860
PVC100C16020G	10" SDR 26 GE	160	.413	10.750	9.924	9.030
PVC100C20020G	10" SDR 21 GE	200	.511	10.750	9.728	11.040
PVC120C16020G	12" SDR 26 GE	160	.490	12.750	11.770	12.710
PVC120C20020G	12" SDR 21 GE	200	.606	12.750	11.538	15.497

Prices are subject to change without notice.

Returns are subject to a restock fee.

Special Orders are non-returnable.

TITAN INDUSTRIES, INC.
a world of products for the world of water

C900 & C905 PIPE DIMENSIONS

Part No.	Description	Available	PSI	Wall	O.D.	I.D.	Wt./Ft.
PVC040DR2520G	4" DR 25	Gasket End	100	.192	4.800	4.416	1.846
PVC040DR1820G	4" DR 18	Gasket End	150	.267	4.800	4.266	2.522
PVC040DR1420G	4" DR 14	Gasket End	200	.343	4.800	4.114	3.182
PVC060DR2520G	6" DR 25	Gasket End	100	.276	6.900	6.348	3.831
PVC060DR1820G	6" DR 18	Gasket End	150	.383	6.900	6.134	5.226
PVC060DR1420G	6" DR 14	Gasket End	200	.493	6.900	5.914	6.605
PVC080DR2520G	8" DR 25	Gasket End	100	.362	9.050	8.326	6.618
PVC080DR1820G	8" DR 18	Gasket End	150	.503	9.050	8.044	9.040
PVC080DR1420G	8" DR 14	Gasket End	200	.646	9.050	7.758	11.410
PVC100DR2520G	10" DR 25	Gasket End	100	.444	11.100	10.212	10.005
PVC100DR1820G	10" DR 18	Gasket End	150	.617	11.100	9.866	13.666
PVC100DR1420G	10" DR 14	Gasket End	200	.793	11.100	9.514	17.250
PVC040DR2520G	12" DR 25	Gasket End	100	.528	13.200	12.144	14.180
PVC040DR1820G	12" DR 18	Gasket End	150	.733	13.200	11.734	19.354
PVC040DR1420G	12" DR 14	Gasket End	200	.943	13.200	11.314	24.450
PVC140DR2520G	14" DR 41	Gasket End	100	.373	15.300	14.554	12.100
PVC140DR1820G	14" DR 25	Gasket End	165	.612	15.300	14.076	19.074
PVC140DR1420G	14" DR 18	Gasket End	235	.850	15.300	13.600	26.044
PVC160DR2520G	16" DR 41	Gasket End	100	.424	17.400	16.552	15.482
PVC160DR1820G	16" DR 25	Gasket End	165	.696	17.400	16.008	24.739
PVC160DR1420G	16" DR 18	Gasket End	235	.967	17.400	15.466	33.768
PVC180DR2520G	18" DR 41	Gasket End	100	.475	19.500	18.550	19.760
PVC180DR1820G	18" DR 25	Gasket End	165	.780	19.500	17.940	31.138
PVC180DR1420G	18" DR 18	Gasket End	235	1.083	19.500	17.334	42.481
PVC200DR2520G	20" DR 41	Gasket End	100	.527	21.600	20.546	24.330
PVC200DR1820G	20" DR 25	Gasket End	165	.864	21.600	19.872	38.372
PVC200DR1420G	20" DR 18	Gasket End	235	1.200	21.600	19.200	52.368
PVC240DR2520G	24" DR 41	Gasket End	100	.629	25.800	24.542	35.010
PVC240DR1820G	24" DR 25	Gasket End	165	1.032	25.800	23.736	55.342
PVC240DR1420G	24" DR 18	Gasket End	235	1.433	25.800	22.934	75.520
PVC300DR2520G	30" DR 41	Gasket End	100	.780	32.000	30.440	53.600
PVC300DR1820G	30" DR 32.5	Gasket End	125	.985	32.000	30.030	66.605
PVC300DR1420G	30" DR 25	Gasket End	165	1.280	32.000	29.440	85.698

TITAN INDUSTRIES, INC.
a world of products for the world of water

*Prices are subject to change without notice.
Returns are subject to a restock fee.
Special Orders are non-returnable.*

HDPE 3408 PIPE DIMENSIONS

Pressure Rating		225 psi DR 7.3		200 psi DR 9.0		160 psi DR 11.0		130 psi DR 13.5		110 psi DR 15.5	
IPS * Pipe Size	Nominal O.D. (in.)	Minimum Wall (in.)	Weight LB/FT	Minimum Wall (in.)	Weight LB/FT	Minimum Wall (in.)	Weight LB/FT	Minimum Wall (in.)	Weight LB/FT	Minimum Wall (in.)	Weight LB/FT
1 1/4"	1.660	0.227	0.44	0.184	0.37	0.151	0.31	0.123	0.26	0.107	0.23
1 1/2"	1.900	0.260	0.58	0.211	0.49	0.173	0.41	0.141	0.34	0.123	0.30
2"	2.375	0.325	0.91	0.264	0.76	0.216	0.64	0.176	0.53	0.153	0.47
3"	3.500	0.479	1.98	0.389	1.65	0.318	1.39	0.259	1.15	0.226	1.02
4"	4.500	0.616	3.27	0.500	2.74	0.409	2.30	0.333	1.90	0.29	1.67
5 3/8"	5.375	0.736	4.66	0.597	3.90	0.489	3.27	0.398	2.72	0.347	2.40
5"	5.563	0.762	5.00	0.618	4.18	0.506	3.50	0.412	2.91	0.359	2.57
6"	6.625	0.908	7.09	0.736	5.93	0.602	4.97	0.491	4.13	0.427	3.64
7 1/8"	7.125	0.976	8.20	0.792	6.87	0.648	5.75	0.528	4.78	0.46	4.21
8"	8.625	1.182	12.01	0.958	10.05	0.784	8.42	0.639	7.00	0.556	6.16
10"	10.750	1.473	18.66	1.194	15.62	0.977	13.09	0.796	10.87	0.694	9.59
12"	12.750	1.747	26.25	1.417	21.97	1.159	18.42	0.944	15.30	0.823	13.47
13 3/8"	13.375	1.832	28.88	1.486	24.17	1.216	20.26	0.991	16.83	0.863	14.83
14"	14.000	1.918	31.64	1.556	26.49	1.273	22.20	1.037	18.44	0.903	16.24
16"	16.000	2.192	41.34	1.778	34.61	1.455	29.00	1.185	24.09	1.032	21.21
18"	18.000	2.466	52.31	2.000	43.79	1.636	36.69	1.333	30.48	1.161	26.85
20"	20.000	2.740	64.57	2.222	54.05	1.818	45.30	1.481	37.64	1.290	33.13
22"	22.000	3.014	78.15	2.444	65.41	2.000	54.82	1.630	45.56	1.419	40.09
24"	24.000	3.288	92.99	2.667	77.85	2.182	65.24	1.778	54.22	1.548	47.72
26"	26.000	3.562	109.15	2.889	91.35	2.364	76.58	1.926	63.63	1.677	56.02
28"	28.000			3.111	105.96	2.545	88.79	2.074	73.76	1.806	64.94
30"	30.000			3.333	121.62	2.727	101.94	2.222	84.68	1.935	74.56
32"	32.000					2.909	115.99	2.370	96.35	2.065	84.88
34"	34.000					3.091	130.92	2.519	108.80	2.194	95.83
36"	36.000									2.323	107.40
42"	42.000										
48"	48.000										
54"	54.000										

Prices are subject to change without notice.

Returns are subject to a restock fee.

Special Orders are non-returnable.

TITAN INDUSTRIES, INC.

a world of products for the world of water

HDPE 3408 PIPE DIMENSIONS

Pressure Rating		100 psi DR 17.0		80 psi DR 21.0		65 psi DR 26.0		50 psi DR 32.5		40 psi DR 41.0	
IPS * Pipe Size	Nominal O.D. (in.)	Minimum Wall (in.)	Weight LB/FT	Minimum Wall (in.)	Weight LB/FT	Minimum Wall (in.)	Weight LB/FT	Minimum Wall (in.)	Weight LB/FT	Minimum Wall (in.)	Weight LB/FT
1 1/4"											
1 1/2"											
2"	2.375	0.140	0.43								
3"	3.500	0.206	0.93								
4"	4.500	0.265	1.54	0.214	1.26						
5 3/8"	5.375	0.316	2.20	0.256	1.80	0.207	1.47				
5"	5.563	0.327	2.35	0.265	1.93	0.214	1.58				
6"	6.625	0.390	3.34	0.315	2.73	0.255	2.23	0.204	1.80		
7 1/8"	7.125	0.419	3.86	0.339	3.16	0.274	2.58	0.219	2.08		
8"	8.625	0.507	5.65	0.411	4.64	0.332	3.79	0.265	3.05		
10"	10.750	0.632	8.78	0.512	7.21	0.413	5.87	0.331	4.75		
12"	12.750	0.750	12.36	0.607	10.13	0.490	8.26	0.392	6.67		
13 3/8"	13.375	0.787	13.60	0.637	11.15	0.514	9.09	0.412	7.35		
14"	14.000	0.824	14.91	0.667	12.22	0.538	9.96	0.431	8.05		
16"	16.000	0.941	19.46	0.762	15.97	0.615	13.02	0.492	10.51		
18"	18.000	1.059	24.65	0.857	20.19	0.692	16.48	0.554	13.29		
20"	20.000	1.176	30.42	0.952	24.92	0.769	20.34	0.615	16.41		
22"	22.000	1.294	36.81	1.048	30.19	0.846	24.62	0.677	19.87		
24"	24.000	1.412	43.82	1.143	35.92	0.923	29.29	0.738	23.62		
26"	26.000	1.529	51.40	1.238	42.13	1.000	34.39	0.800	27.74		
28"	28.000	1.647	59.62	1.333	48.86	1.077	39.89	0.862	32.20		
30"	30.000	1.765	68.45	1.429	56.13	1.154	45.78	0.923	36.92	0.732	29.50
32"	32.000	1.882	77.86	1.524	63.83	1.231	52.10	0.985	42.04	0.780	33.53
34"	34.000	2.000	87.91	1.619	72.06	1.308	58.79	1.046	47.44	0.829	37.87
36"	36.000	2.118	98.56	1.714	80.79	1.385	65.93	1.108	53.18	0.878	42.47
42"	42.000			2.000	109.97	1.615	89.71	1.292	72.40	1.024	57.74
48"	48.000			2.286	143.64	1.846	117.20	1.477	94.58	1.171	75.48
54"	54.000			2.571	181.74	2.077	148.35	1.662	119.72	1.317	95.52

TITAN INDUSTRIES, INC.
a world of products for the world of water

*Prices are subject to change without notice.
Returns are subject to a restock fee.
Special Orders are non-returnable.*

DOERR METAL PRODUCTS SPECIFICATIONS

DOERR GRAVEL GUARD'S TWIN LOUVERS INCREASE WATER ACCESS WHILE PROTECTING AGAINST SAND AND GRAVEL.

DOERR'S ORIGINAL PERFORATING PROCESS PRODUCES 72 UNIFORM OPENINGS PER SQUARE FOOT. THE DIE-FORMED OPENINGS, 2-1/4" LONG, PROVIDE A TOTAL OF 162 LINEAR INCHES OF OPEN SLOT IN EVERY SQUARE FOOT OF GRAVEL GUARD SCREEN.

SINCE THE SLOTS ARE DIE-FORMED, NO METAL IS REMOVED, AND THE OPENINGS ARE UNIFORM.

THICKNESS	DEPTHS
.250 IN	1/32" TO 1/8" (0.03125 TO 0.125)
7 GA	1/32" TO 5/32" (0.03125 TO 0.15625)
10 GA	1/32" TO 3/16" (0.03125 TO 0.1875)

FILTERING AREA CHART								
SCREEN O.D.	AREA IN SQ INCHES PER LINEAR FOOT	FILTERING AREA IN SQUARE INCHES PER LINEAR FOOT						
		1/32"	1/16"	3/32"	1/8"	5/32"	3/16"	1/4"
6-5/8"	226	6.8526	13.9212	20.6604	28.6848	36.3744	44.2962	60.7500
8-5/8"	302	9.1368	18.5616	27.5472	38.2464	48.4992	57.8196	81.0000
10-3/4"	377	11.4210	23.2000	34.4340	47.8080	60.6240	73.8270	101.2500
12-3/4"	452	13.7052	27.8424	41.3208	57.3696	72.7488	88.5924	121.5000
14"	528	15.2280	30.9360	45.9120	63.7440	80.8320	98.4360	135.0000
16"	603	17.1315	34.8030	51.6510	71.7120	90.9360	110.7405	151.8750
18"	679	19.7964	40.2168	59.6856	82.8672	105.0816	127.9668	175.5000
20"	754	21.6999	44.0838	65.4246	90.8352	115.1856	140.2713	192.3750
24"	905	25.8876	52.5912	78.0504	108.3648	127.4144	167.3412	229.5000
30"	1131	32.7402	66.5124	97.7108	137.0496	173.7888	211.6374	290.2500
36"	1357	39.2121	79.6602	118.2234	164.1408	208.1424	253.4727	347.6250
42"	1583	45.6840	92.8080	137.7360	191.2320	242.4960	295.3080	405.0000
48"	1810	52.5366	106.7292	158.3964	219.9168	278.8704	339.6042	465.7500

BRIDGE-SLOT WELL SCREEN						
O.D.	MILD STEEL				STAINLESS STEEL	
	10 GA #/FT	7 GA #/FT	.219 #/FT	.250 #/FT	10 GA #/FT	7 GA #/FT
8-5/8"	12.50	16.50	19.66	22.36	13.00	17.35
10-3/4"	15.86	20.77	24.63	28.42	16.30	21.67
12-3/4"	18.85	24.60	29.31	33.75	19.40	25.75
14"	21.08	27.54	32.23	37.25	21.33	28.35
16"	24.06	31.50	36.91	42.84	24.00	31.77
18"	27.04	35.45	41.59	48.40	27.50	36.50
20"	30.03	39.33	46.27	53.49	30.50	40.50
24"	36.00	47.33	56.22	64.25	36.65	48.70
30"		59.27	70.47	80.51		
36"		71.22	84.52	96.77		
42"		83.17	98.75	112.19		
48"		95.05	112.93	129.16		

WELL SCREEN BOTTOMS					
O.D.	10 GA	7 GA	.219	.250	
8-5/8"	2.5	3	3.5	4	
10-3/4"	3.5	5	5.5	6.5	
12-3/4"	5	7	8	9	
14"	6	8	9.5	11	
16"	8	10.5	12.5	14.5	
18"	10	13	16	18	
20"	12	16.5	19.5	22.5	
24"	18	23.5	28	32.5	

DOERR MILD STEEL PUNCHED WELL SCREEN

Part No.	O.D.	Gauge	Net Price per Foot
SSC085134G20S	8-5/8"	10	
SSC085188G20S	8-5/8"	7	
SSC085219G20S	8-5/8"	.219"	
SSC085250G20S	8-5/8"	.250"	
SSC103134G20S	10-3/4"	10	
SSC103188G20S	10-3/4"	7	
SSC103219G20S	10-3/4"	.219"	
SSC103250G20S	10-3/4"	.250"	
SSC123134G20S	12-3/4"	10	
SSC123188G20S	12-3/4"	7	
SSC123219G20S	12-3/4"	.219"	
SSC123250G20S	12-3/4"	.250"	
SSC143134G20S	14"	10	
SSC143188G20S	14"	7	
SSC143219G20S	14"	.219"	
SSC143250G20S	14"	.250"	
SSC163134G20S	16"	10	
SSC163188G20S	16"	7	
SSC163219G20S	16"	.219"	
SSC163250G20S	16"	.250"	
SSC183134G20S	18"	10	
SSC183188G20S	18"	7	
SSC183219G20S	18"	.219"	
SSC183250G20S	18"	.250"	
SSC200134G20S	20"	10	
SSC200188G20S	20"	7	
SSC200219G20S	20"	.219"	
SSC200250G20S	20"	.250"	
SSC240134G20S	24"	10	
SSC240188G20S	24"	7	
SSC240219G20S	24"	.219"	
SSC240250G20S	24"	.250"	
SSC300188G20S	30"	7	
SSC300219G20S	30"	.219"	
SSC300250G20S	30"	.250"	

TITAN INDUSTRIES, INC.
a world of products for the world of water

*Prices are subject to change without notice.
Returns are subject to a restock fee.
Special Orders are non-returnable.*

BLACK, GALVANIZED, COATED & THREAD & COUPLED PIPE DIMENSIONS

PIPE SIZE	O.D.	5	10	20	30	STD	40	60	XH	80	100	120	140	160	XXH
		WALL #/FT	WALL #/FT	WALL #/FT	WALL #/FT	WALL #/FT	WALL #/FT	WALL #/FT	WALL #/FT	WALL #/FT	WALL #/FT	WALL #/FT	WALL #/FT	WALL #/FT	WALL #/FT
1/8	.405	.035	.049			.068	.068		.095	.095					
		.138	.186			.245	.245		.315	.315					
1/4	.540	.049	.065			.088	.088		.119	.119					
		.257	.330			.425	.425		.535	.535					
3/8	.675	.049	.065			.091	.091		.126	.126					
		.328	.424			.568	.568		.738	.738					
1/2	.840	.065	.083			.109	.109		.147	.147				.188	.294
		.538	.671			.851	.851		1.088	1.088				1.304	1.714
3/4	1.050	.065	.083			.113	.113		.154	.154				.219	.308
		.689	.857			1.131	1.131		1.474	1.474				1.94	2.441
1	1.315	.065	.109			.133	.133		.179	.179				.250	.358
		.868	1.404			1.679	1.679		2.172	2.172				2.844	3.659
1-1/4	1.660	.065	.109			.140	.140		.191	.191				.250	.382
		1.107	1.806			2.273	2.273		2.997	2.997				3.765	5.214
1-1/2	1.900	.065	.109			.145	.145		.200	.200				.200	.400
		1.274	2.085			2.718	2.718		3.631	3.631				4.859	6.408
2	2.375	.065	.109			.154	.154		.218	.218				.344	.436
		1.604	2.638			3.653	3.653		5.022	5.022				7.46	9.029
2-1/2	2.875	.083	.120			.203	.203		.276	.276				.375	.552
		2.475	3.531			5.793	5.793		7.661	7.661				10.01	13.70
3	3.50	.083	.120			.216	.216		.300	.300				.438	.600
		3.029	4.332			7.576	7.576		10.25	10.25				14.32	18.58
3-1/2	4.00	.083	.120			.226	.226		.318	.318					.636
		3.472	4.973			9.109	9.109		12.51	12.51					22.85
4	4.50	.083	.120			.237	.237		.337	.337		.438		.531	.674
		3.915	5.613			10.79	10.79	12.66	14.98	14.98		19.01		22.51	27.54
4-1/2	5.00					.247	.247		.355						.710
						12.53	12.53		17.61						32.53
5	5.563	.109	.134	.203		.258	.258		.375	.375		.500		.625	.750
		6.349	7.770	11.62		14.62	14.62		20.78	20.78		27.04		32.96	38.55
6	6.625	.109	.134	.203		.280	.280		.432	.432		.562		.719	.864
		7.585	9.289	13.92		18.97	18.97		28.57	28.57		36.39		45.35	53.16
7	7.625					.301			.500						.875
						23.57			38.05						63.08
8	8.625	.109	.148	.250	.277	.322	.322	.406	.500	.500	.594	.719	.812	.906	.875
		9.914	13.40	22.36	24.70	28.55	28.55	35.64	43.39	43.39	50.95	60.71	67.76	74.69	72.42
9	9.625					.342			.500						
						33.90			48.72						
10	10.75	.134	.165	.250	.307	.365	.365	.500	.500	.594	.719	.844	1.000	1.125	1.000
		15.19	18.70	28.04	34.24	40.48	40.48	54.74	54.74	64.43	77.03	89.29	104.13	115.64	104.13
11	11.75					.375			.500						
						45.55			60.07						
12	12.75	.165	.180	.250	.330	.375	.406	.562	.500	.688	.844	1.00	1.125	1.312	
		22.18	24.20	33.38	43.77	49.56	53.53	73.16	65.42	88.63	107.32	125.50	139.70	160.30	
14	14.00		.250	.312	.375	.375	.438	.594	.500	.750	.938	1.094	1.250	1.406	
			36.71	45.61	54.57	54.57	63.44	85.05	72.09	106.10	130.85	150.79	170.20	189.10	
16	16.00		.250	.312	.375	.375	.500	.656	.500	.844	1.031	1.219	1.438	1.594	
			42.05	52.27	62.58	62.58	82.77	107.50	82.77	136.60	164.80	192.43	223.64	245.25	
18	18.00		.250	.312	.438	.375	.562	.750	.500	.938	1.156	1.375	1.562	1.781	
			47.39	58.94	82.15	70.59	104.67	138.20	93.45	170.92	207.96	244.10	274.20	308.50	
20	20.00		.250	.375	.500	.375	.594	.812	.500	1.031	1.281	1.500	1.750	1.969	
			52.73	78.60	104.10	78.60	123.11	166.40	104.10	208.90	256.10	296.40	341.10	379.20	
22	22.00		.250	.375	.500	.375		.875	.500	1.125	1.375	1.625	1.875	2.125	
			58.07	86.61	114.80	86.61		197.40	114.80	250.80	302.88	353.60	403.00	451.10	
24	24.00		.250	.375	.500	.375	.688	.969	.500	1.125	1.531	1.812	2.062	2.344	
			63.41	94.62	140.80	94.62	171.29	238.35	125.50	296.58	367.40	429.40	483.10	542.10	
26	26.00		.312	.500		.375			.500						
			85.60	136.17		102.63			136.17						
28	28.00		.312	.500	.625	.375			.500						
			92.26	146.85	182.73	110.64			146.85						
30	30.00		.312	.500	.625	.375			.500						
			98.93	157.53	196.08	118.65			157.53						
32	32.00		.312	.500	.625	.375	.688		.500						
			105.59	168.21	209.43	126.66	203.08		168.21						
34	34.00		.312	.500	.625	.375	.688		.500						
			112.25	178.89	222.78	134.67	244.77		178.89						
36	36.00		.312	.500	.625	.375	.750		.500						
			118.92	189.57	236.13	142.68	282.35		189.57						
42	42.00					.375			.500						
						166.71			221.61						
48	48.00					.375			.500						
						190.74			253.65						

GALVANIZED & BLACK PIPE BUNDLE QTYS

A53 DOMESTIC BUNDLE QUANTITIES										
SIZE	WALL	FEET	JOINTS	WEIGHT		SIZE	WALL	FEET	JOINTS	WEIGHT
1/2"	SCH40	2520	120	2145		1/2"	SCH80	1827	87	1986
3/4"	SCH40	1764	84	2000		3/4"	SCH80	1365	65	2011
1"	SCH40	1260	60	2120		1"	SCH80	924	44	2006
1-1/4"	SCH40	882	42	2010		1-1/4"	SCH80	672	32	2013
1-1/2"	SCH40	756	36	2065		1-1/2"	SCH80	567	27	2059
2"	SCH40	546	26	2010		2"	SCH80	399	19	2004
2-1/2"	SCH40	336	16	1955		2-1/2"	SCH80	273	13	2091
3"	SCH40	273	13	2080		3"	SCH80	189	9	1938
3-1/2"	SCH40	231	11	2125		3-1/2"	SCH80	168	8	2101
4"	SCH40	189	9	2060		4"	SCH80	147	7	2203
A53 IMPORT BUNDLE QUANTITIES										
SIZE	WALL	FEET	JOINTS	WEIGHT		SIZE	WALL	FEET	JOINTS	WEIGHT
1/2"	SCH40	2520	120	2145		1/2"	SCH80	2520	120	2742
3/4"	SCH40	1764	84	2000		3/4"	SCH80	1764	84	2600
1"	SCH40	1260	60	2120		1"	SCH80	1260	60	2737
1-1/4"	SCH40	882	42	2010		1-1/4"	SCH80	882	42	2643
1-1/2"	SCH40	756	36	2065		1-1/2"	SCH80	756	36	2745
2"	SCH40	546	26	2010		2"	SCH80	546	26	2742
2-1/2"	SCH40	378	18	2190		2-1/2"	SCH80	378	18	2896
3"	SCH40	294	14	2227		3"	SCH80	294	14	3014
3-1/2"	SCH40	252	12	2295		3-1/2"	SCH80	210	10	3146
4"	SCH40	210	10	2266						

TITAN INDUSTRIES, INC.
a world of products for the world of water

*Prices are subject to change without notice.
 Returns are subject to a restock fee.
 Special Orders are non-returnable.*

CALCULATING THE INTAKE OPEN AREA OF TITAN'S PVC SLOTTED SCREEN

PIPE SIZE	OUTSIDE DIAMETER	WALL THICKNESS SCH 40	WALL THICKNESS SCH 80	MAX ROWS OF SLOTS	SLOT LENGTH SCH 40	SLOT LENGTH SCH 80	SLOT WIDTH	SLOT/ROW FOOT	SLOT SPACING
1/2"	.840"	.109"	.147"	2	.47"	.45"	.010" & .015" & .020"	80	1/8"
3/4"	1.050"	.113"	.154"	2	.68"	.62"		42	1/4"
1"	1.315"	.113"	.179"	3	.70"	.65"		21	1/2"
1-1/4"	1.660"	.140"	.191"	3	.78"	.74"		15	3/4"
1-1/2"	1.900"	.145"	.200"	3	.88"	.75"	.032" & .062"	11	1"
2"	2.375"	.154"	.218"	3	1.50"	1.30"		6	2"
2-1/2"	2.875"	.203"	.276"	3	1.40"	1.32"		4	3"
3"	3.500"	.216"	.300"	3	1.54"	1.40"		2	6"
4"	4.500"	.237"	.337"	4 OR 6	1.50"/1.10"	1.20"/NA	.093"	32	1/4"
4-1/2"	4.950"	.248"	NA	4	1.47"	NA		19	1/2"
5"	5.563"	.258"	.375"	4	1.45"	1.40"		13	3/4"
6"	6.625"	.280"	.432"	4	1.45"	1.40"		11	1"
8"	8.625"	.332"	.500"	5	1.90"	1.80"	.125"	6	2"
10"	10.750"	.365"	.593"	6	2.35"	1.60"		4	3"
12"	12.750"	.460"	.687"	7	2.40"	1.60"		2	6"
14"	14.000"	.438"	.750"	7 OR 8	2.75"	2.20"		19	1/2"
16"	16.000"	.500"	.843"	8	2.24"	1.73"	.187"	14	3/4"
18"	18.000"	.532"	.937"	10	2.30"	1.57"		11	1"
								5	2"
								4	3"
							.250"	2	6"
								16	1/2"
								12	3/4"
								10	1"
							.375"	5	2"
								3.5	3"
								2	6"
								14	1/2"
							.375"	11	3/4"
								9	1"
								5	2"
								3.5	3"
							.375"	2	6"
								2	6"

APPROXIMATE OPEN AREA PER FOOT OF SCREEN FOR A VARIETY OF SLOT CONFIGURATIONS CAN BE EASILY CALCULATED BY THE FOLLOWING INSTRUCTIONS AND ABOVE CHARTS;

1. CHOOSE THE SIZE AND SCHEDULE OF PVC SCREEN
2. CHOOSE A SLOT CONFIGURATION
 - A. ROWS OF SLOTS
 - B. SLOT LENGTH
 - C. SLOT WIDTH
 - D. SLOTS PER ROW PER FOOT
3. MULTIPLY THE FIGURE FOR A, B, C, & D FOR THE TOTAL OPEN AREA PER FOOT OF SLOTTED PVC SCREEN.

EXAMPLE: 4" SCH 40 WITH 4 ROWS OF .010" WIDE SLOTS ON 90° CENTERS WITH 1/4" SPACING. 4 ROWS (A) X 1.5" (B) X .010" © X 42 (D) = 2.52 SQUARE INCHES OF OPEN AREA PER FOOT OF SLOTTED PVC SCREEN.

COMMON PIPE SIZES AND SLOT CONFIGURATIONS ARE SHOWN, OTHER SIZES UP TO 48",SCH OR SDR'S, AND SLOT PATTERNS ARE AVAILABLE UPON REQUEST. SLOT SPACING AND SLOT LENGTH IS NOMINAL, SMALL VARIANCES MAY OCCUR DUE TO OVALITY OF PIPE AND THE EFFECTS OF TEMPERATURE.

CALCULATING THE AMOUNT OF WATER FLOW (GPM) THROUGH SLOTTED PVC WELL SCREEN

FIRST CALCULATE THE AMOUNT OF OPEN AREA PER LINEAR FOOT:

NUMBER/ROWS X SLOTS/ROW X SLOT WIDTH X SLOT LENGTH = SQ. INCH PER FT.

AN EXAMPLE OF THIS WOULD BE:

5" SDR 21 WITH 4 ROWS OF .032" SLOT ON 1/4" (.250") SPACING

OPEN AREA = 4 X 42 X .032 X 2.125" (INSIDE LENGTH) = 11.42 SP. IN./FT.

TO DETERMINE WATER FLOW AT ENTRANCE VELOCITY OF .1 FT. PER SECOND:

MULTIPLY SQUARE INCHES X .31 = GPM AT .1 FT. PER SECOND (IDEAL)

11.42 X .31 = 3.54 GPM PER FOOT

IF 40' OF SCREEN = 3.54 X 40 = 141.6 GPM (IF 40' OF SCREEN)

ANOTHER EXAMPLE OF THIS WOULD BE:

12" SDR 21 WITH 10 ROWS OF .040" SLOT ON 1/4" (.250") SPACING

OPEN AREA = 10 X 41 X .040 X 2.125" (INSIDE LENGTH) = 34.85 SQ. IN./FT.

TO DETERMINE WATER FLOW AT ENTRANCE VELOCITY OF .1 FT. PER SECOND:

MULTIPLY SQUARE INCHES X .31 = GPM AT .1 FT. PER SECOND (IDEAL)

34.85 X .31 = 10.8 GPM PER FOOT

IF 80' OF SCREEN = 10.8 X 80 = 864.0 GPM (IF 80' OF SCREEN)

ANOTHER WAY OF LOOKING AT THIS IS TO TOTAL THE SQUARE INCHES OF OPEN AREA X
THE AMOUNT OF SCREEN:

34.85 SQ. IN. X 80 = 2,788 SQ. INCHES = 19.36 SQ. FT.

THIS IS ROUGHLY EQUIVALENT TO A SQUARE HOLE OF 4.4' X 4.4'

BASED ON THE ABOVE, YOU COULD SAFELY ASSUME THAT THIS AMOUNT OF OPEN AREA WOULD,
IN ACTUAL FACT, YIELD FAR IN EXCESS OF THE 864 GPM NOTED IN THE SECOND EXAMPLE.

OBVIOUSLY THIS IS BASED UPON THE WATER BEING AVAILABLE IN THE FORMATION, BECAUSE NEITHER
TITAN (NOR ANY OTHER MANUFACTURER'S SLOTTED PVC) WILL PRODUCE WATER IF IT IS NOT THERE
TO START WITH.

OPEN AREA PER LINEAR FOOT EASY-FLO & FOUR SQUARE PVC SCREEN

NOTE: SPACING BETWEEN SLOTS IS .250". THERE ARE 43 SLOTS PER FT./PER ROW FOR THE FOLLOWING SLOT SIZES: .010" - .025". THERE ARE 42 SLOTS PER FT./PER ROW FOR A .032" SLOT, 41 SLOTS FOR A .040" SLOT, 40 SLOTS FOR A .050" SLOT AND 38 SLOTS PER FT./PER ROW FOR A .060" SLOT. OPEN AREA EXPRESSED IN SQUARE INCHES.

THIS AMOUNT IS APPROXIMATE. ACTUAL AMOUNT MAY EXCEED THE NUMBERS NOTED. INSIDE SLOT LENGTHS ARE AS FOLLOWS: 1/2" - .250"; 3/4" - .350"; 1" - .600"; 1-1/4" - 1.000"; 1-1/2" - 1.250"; 2" - 1.375"; 2-1/2" - 1.500"; 3" - 1.750"; 4" - 2.000"; 4-1/2", 5", 6", 8", 10" - 2.125"; 12", 16" AND LARGER DEPEND ON SLOT SIZES AND WALL THICKNESS OF SCREEN.

SCREEN DIA	NO. ROWS.	.010	.012	.016	.018	.020	.025	.032	.040	.050	.060
1/2"	2	.215	.258	.344	.387	.430	.538	.672	.820	1.000	1.140
3/4"	2	0.301	.361	.482	.542	.602	.753	.941	1.148	1.400	1.596
1"	2	0.516	.619	.826	.929	1.032	1.290	1.613	1.968	2.400	2.736
1-1/4"	2	.860	1.032	1.376	1.548	1.720	2.150	2.688	3.280	4.000	4.560
1-1/2"	2	1.075	1.290	1.720	1.935	2.150	2.688	3.360	4.100	5.000	5.700
2"	3	1.77	2.13	2.84	3.19	3.55	4.43	5.54	6.77	8.25	9.41
2-1/2"	3	1.94	2.32	3.10	3.48	3.87	4.84	6.05	7.38	9.00	10.26
3"	3	2.26	2.71	3.61	4.06	4.52	5.64	7.06	8.61	10.50	11.97
4"	4	3.44	4.13	5.50	6.19	6.88	8.60	10.75	13.12	16.00	18.24
4-1/2"	4	3.66	4.39	5.85	6.58	7.31	9.14	11.42	13.94	17.00	19.38
5"	4	3.66	4.39	5.85	6.58	7.31	9.14	11.42	13.94	17.00	19.38
6"	5	4.57	5.48	7.31	8.22	9.14	11.42	14.28	17.43	21.25	24.23
8"	6				9.87	10.97	13.71	17.14	20.91	25.50	29.64
10"	8				13.16	14.62	18.28	22.85	27.88	34.00	37.05
12"								28.56	34.85	42.50	44.46
16"								34.27	40.80	51.00	59.28

OPEN AREA PER LINEAR FOOT HI-FLO PREMIUM PVC SCREEN

NOTE: THESE FIGURES APPLY TO BELLED END, PLAIN END, AND FLUSH JOINT HI-FLO SCREENS. SPACING BETWEEN SLOTS FOR HI-FLO IS .125". EACH OF THE SLOT SIZES AVAILABLE HAS THE FOLLOWING NUMBER OF SLOTS PER FOOT: .010" - 86 SLOTS/FT.; .012" - 85 SLOTS/FT.; .016" - 84 SLOTS/FT.; .018" - 83 SLOTS/FT.; .020" - 82 SLOTS/FT.; .025" - 80 SLOTS/FT.

THIS AMOUNT IS APPROXIMATE. ACTUAL AMOUNT MAY EXCEED THE NUMBERS NOTED. INSIDE SLOT LENGTHS ARE AS FOLLOWS: 1/2" - .250"; 3/4" - .350"; 1" - .600"; 1-1/4" - 1.000"; 1-1/2" - 1.250"; 2" - 1.375"; 2-1/2" - 1.500"; 3" - 1.750"; 4" - 2.000"; 4-1/2", 5", AND 6" - 2.125". WE HAVE FOUND THE NUMBER OF ROWS OF SLOTS AS NOTED BELOW TO BE THE OPTIMUM IN OPEN AREA. HOWEVER, MORE OR LESS ROWS OF SLOT MAY BE PUT IN, WHICH WILL EFFECT THE LENGTHS OF SLOTS AND THE AMOUNT OF OPEN AREA ACCORDINGLY.

SCREEN	NO. ROWS.	.010	.012	.016	.018	.020	.025
1/2"	2	.430	.510	.672	0.747	.820	1.000
3/4"	2	.602	.714	.941	1.046	1.148	1.400
1"	2	1.032	1.224	1.613	1.793	1.968	2.400
1-1/4"	2	1.720	2.040	2.688	2.988	3.280	4.000
1-1/2"	2	2.150	2.550	3.360	3.735	4.100	5.000
2"	3	3.548	4.208	5.544	6.163	6.765	8.250
2-1/2"	3	3.870	4.590	6.048	6.723	7.380	9.000
3"	3	4.515	5.355	7.056	7.344	8.610	10.500
4"	4	6.880	8.160	10.752	11.952	13.120	16.000
4-1/2"	4	7.310	8.670	11.424	12.699	13.940	17.000
5"	4	7.310	8.760	11.424	12.699	13.940	17.000
6"	5	9.138	10.838	14.280	15.874	17.425	21.250

.025 IS AVAILABLE IN .125" SPACING, BUT IS NOT RECOMMENDED FOR STRENGTH PURPOSES. OTHER LARGER SIZES REQUIRE SPECIAL ORDER.

TITAN INDUSTRIES, INC.
a world of products for the world of water

Prices are subject to change without notice.

Returns are subject to a restock fee.

Special Orders are non-returnable.

FORMULA TO FIGURE TENSILE STRENGTH OF HDPE

TAKE (AREA OF OD - AREA OF ID) X 3500 PSI = TENSILE STRENGTH OF PIPE IN POUNDS.

WHERE (AREA OF OD - AREA OF ID) = CROSS SECTION OF PIPE

FORMULA FOR AREA = π X (RADIUS SQUARED)

EXAMPLE WITH 2" SDR11 OD IS 2.375 INCHES

ID IS 1.943 INCHES

WALL THICKNESS IS .216 INCHES

AREA OF OD $3.1416 \times (1.1875 \text{ SQUARED}) = 4.43$

AREA OF ID $3.1416 \times (0.9715 \text{ SQUARED}) = 2.97$

$4.43 - 2.97 = 1.46$ CROSS SECTION OF PIPE

$1.46 \times 3500 \text{ PSI} = 5110 \text{ POUNDS MAXIMUM} *$

FORMULA TO FIGURE TENSILE STRENGTH OF ROUND HOLE PERFORATED PATTERN IN HDPE

SUBTRACT THE AMOUNT OF THE CROSS SECTION TAKEN UP BY THE HOLES FROM THE TENSILE STRENGTH OF THE BASE MATERIAL.

HOLE DIAMETER X WALL THICKNESS X NUMBER OF ROWS = CROSS SECTION REMOVED

FOR 4 ROWS OF 1/2 INCH HOLES.

$0.500 \times 0.216 \times 4 = .432$ CROSS SECTION REMOVED FROM PIPE

SUBTRACT CROSS SECTION REMOVED FROM CROSS SECTION OF SOLID PIPE.

FROM EXAMPLE USING 2 INCH PIPE WITH A CROSS SECTION OF 1.465

$1.465 - 0.432 = 1.03$ CROSS SECTION REMAINING

$1.03 \times 3500 \text{ PSI} = 3605 \text{ POUNDS MAXIMUM} *$

FORMULA TO FIGURE TENSILE STRENGTH OF SLOTTED SCREEN PATTERN IN HDPE

TAKE AN AVERAGE OF THE OUTSIDE SLOT LENGTH AND THE INSIDE SLOT LENGTH TO USE IN THE FORMULA OF CROSS SECTION REMOVED.

EXAMPLE IN THE 2" SDR11 HDPE WITH 2 ROWS OF SLOTS

OUTSIDE SLOT LENGTH IS 1.50 INCHES

INSIDE SLOT LENGTH IS 1.25 INCHES

TAKE $(1.50 + 1.25)$ DIVIDED BY 2 = 1.375 INCH AVERAGE SLOT LENGTH

$1.375 \text{ SLOT LENGTH} \times .216 \text{ WALL THICKNESS} \times 2 \text{ ROWS OF SLOTS} = .594$ CROSS SECTION

REMOVED FROM PIPE

$1.465 \text{ PIPE CROSS SECTION} - .594 \text{ REMOVED CROSS SECTION} = 0.87$ REMAINING CROSS

SECTION OF PIPE

$0.87 \text{ CROSS SECTION} \times 3500 \text{ PSI} = 3045 \text{ POUNDS MAXIMUM} *$

*NOTE: NORMALLY A 3 TO 1 SAFETY FACTOR IS RECOMMENDED, DUE TO VARIATIONS IN MANUFACTURING TOLERANCES' AND TIME STRENGTH RELATIONSHIPS ON HDPE DIVDE MAXIMUM FIGURE BY 3.

TITAN INDUSTRIES, INC.
a world of products for the world of water

Prices are subject to change without notice.

Returns are subject to a restock fee.

Special Orders are non-returnable.







GLUE & PRIMER

Item	Size	Part No.	List Price	Item	Size	Part No.	List Price
PVC CLEAR CEMENT				WELD ON CEMENT			
4 OZ HARVEY		39-CEMCHV040		QUART		39-CEMWELDQT	
8 OZ HARVEY		39-CEMCHV080		GAL		39-CEMWELDGL	
16 OZ PINT HARVEY		39-CEMCHVPT0		OTHER GLUE			
32 OZ QUART HARVEY		39-CEMCHVQT0		IPS 713 CPVC ORANGE PT		39-CEMWEORPT	
128 OZ GALLON HARVEY		39-CEMCHVGAL		32OZ PVC REG ADVANCED		39-CEMADV32Z	
PVC LIGHT BODY CEMENT				GOLD PVC CEMENT QT		39-CEMGOLDQT	
4 OZ		39-CEMCLT040		QT HOT 203 GLUE		39-CEMHOT203	
8 OZ LT		39-CEMCLT080		PVC CLEAR PRIMER LIGHT			
PINT LT		39-CEMCLTPT0		4 OZ HARVEY		39-PRICLT040	
QUART LT		39-CEMCLTQT0		8 OZ HARVEY		39-PRICLT080	
GALLON LT		39-CEMCLTGAL		16 OZ PINT HARVEY		39-PRICLTPT0	
PVC MEDIUM BODY CEMENT				32 OZ QUART HARVEY		39-PRICLTQT0	
PINT MEDIUM BOCY		39-CEMGRYMDP		128 OZ GALLON HARVEY		39-PRICLTGAL	
QUART MEDIUM BODY		39-CEMGRYMDQ		PVC PURPLE PRIMER			
GALLON MEDIUM BODY		39-CEMGRYMDG		4 OZ		39-PRIPURP04	
CLEAR MEDIUM BODY CEMENT				8 OZ		39-PRIPURP04	
4 OZ		39-CEM308180		PINT		39-PRIPURPPT	
8 OZ		39-CEM310180		QUART		39-PRIPURPQT	
PINT		39-CEM310190		GALLON		39-PRIPURPGL	
QUART		39-CEM310200		LOW-VOC CLEANER			
REGULAR BODY CEMENT				4 OZ CLEANER		39-CLEANER04	
QUART		39-CEM2236S0		8OZ CLEANER		39-CLE7356S0	
PVC CEMENT HEAVY BODY				PT CLEANER		39-CLE7346S0	
PINT		39-CEMHD1PNT		32 OZ CLEANER		39-PUPRI32OZ	
QUART		39-CEMHD1QRT		EZ WELD PRIMER			
QUART GRAY		39-CEM311050		QUART		39-PRIEZWLQT	
QUART GRAY FAST SET		39-CEM311220		GALLON		39-PRIEZWLGL	
1 GAL PVC HEAVY DUTY GRAY		39-GCEMHD1GL		ALL PURPOSE CLEANER			
1 GALLON XHV-GRAY		39-CEMWEGRGL		32 OZ-CLEAR		39-ALLCLEA32	
EZ WELD GLUE				GLUE ACCESSORIES			
EZ WELD GLUE QT		39-CEMEZWLQT		QUART CANW/3" ROLLER		39-MT6483200	
EZ WELD GLUE GL		39-CEMEZWLGL		QUART DAUBER		39-DAUBERQTS	
ALL TEMPERATURE CEMENT				GALLON DAUBER		39-DAUBERGAL	
PINT HT & CLD		39-CEMHTCLPT		GALLON ROLLER DAUBER		39-DAUBERRGL	
QUART HT & CLD		39-CEMHTCLQT		OATEY SPECIALTY BRUSHES		39-SPECBRUCA	
GALLON HT & CLD		39-CEMHTCLGL		32 OZ CARRIER		39-CEMCAR32Z	
WET CONDITION CEMENT				PLUMB-TITE BLUE CEMENT			
4OZ		39-CEMWETB04		8OZ		39-CEMPLMBL8	
8OZ		39-CEMWETB08		PT		39-CEMPLMBLP	
PINT		39-CEMWETBPT					
QUART		39-CEMWETBQT					
GALLON		39-CEMWETBGL					

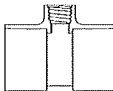
TITAN INDUSTRIES, INC.
a world of products for the world of water

*Prices are subject to change without notice.
Returns are subject to a restock fee.
Special Orders are non-returnable.*









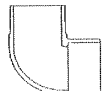
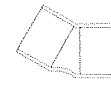

SCHEDULE 40 PVC FITTINGS

Item	Size	Part No.	List Price	Item	Size	Part No.	List Price
REDUCING SLIP TEE (SLIPXFIPT) CONT. 	1-1/4" X 1" X 1"	21-402158000		90° SLIP ELBOW 	3/8"	21-406003000	
	1-1/4" X 1/2"	21-402166000			1/2"	21-406005000	
	1-1/4" X 3/4"	21-402167000			3/4"	21-406007000	
	1-1/4" X 1"	21-402168000			1"	21-406010000	
	1-1/2" X 1-1/4" X 1/2"	21-402199000			1-1/4"	21-406012000	
	1-1/2" X 1-1/4" X 3/4"	21-402201000			1-1/2"	21-406015000	
	1-1/2" X 1-1/4" X 1"	21-402202000			2"	21-406020000	
	1-1/2" X 1/2"	21-402209000			2-1/2"	21-406025000	
	1-1/2" X 3/4"	21-402210000			3"	21-406030000	
	1-1/2" X 1"	21-402211000			4"	21-406040000	
	1-1/2" X 1-1/4"	21-402212000			5"	21-406050000	
	2" X 1-1/2" X 3/4"	21-402238000			6"	21-406060000	
	2" X 1-1/2" X 1"	21-402239000		8"	21-406080000		
	2" X 1/2"	21-402247000		10"	21-406100000		
	2" X 3/4"	21-402248000		12"	21-406120000		
	2" X 1"	21-402249000					
	2" X 1-1/4"	21-402250000					
	2" X 1-1/2"	21-402251000					
	2-1/2" X 1/2"	21-402287000					
	2-1/2" X 3/4"	21-402288000					
	2-1/2" X 1"	21-402289000					
	2-1/2" X 1-1/4"	21-402290000					
	2-1/2" X 1-1/2"	21-402291000					
	3" X 1/2"	21-402333000					
	3" X 3/4"	21-402334000					
	3" X 1"	21-402335000					
	3" X 1-1/4"	21-402336000					
	3" X 1-1/2"	21-402337000					
	3" X 2"	21-402338000					
	4" X 1"	21-402417000					
4" X 1-1/2"	21-402419000						
4" X 2"	21-402420000						
4" X 3"	21-402422000						
5" X 4"	21-402490000						
6" X 2"	21-402528000						
6" X 3"	21-402530000						
6" X 4"	21-402532000						
8" X 3"	21-402580000						
8" X 4"	21-402582000						
TEE (FIPTXFIPT XFIPT) 	1/2"	21-405005000		REDUCING 90° ELBOW (SLIPXFIPT) 	3/8" X 1/2"	21-406053000	
	3/4"	21-405007000			3/4" X 1/2"	21-406101000	
	1"	21-405010000			1" X 1/2"	21-406130000	
	1-1/4"	21-405012000			1" X 3/4"	21-406131000	
	1-1/2"	21-405015000			1-1/4" X 1/2"	21-406166000	
	2"	21-405020000			1-1/4" X 3/4"	21-406167000	
90° ELBOW (FIPTXFIPT) 	1/2"	21-408005000		1-1/4" X 1"	21-406168000		
	3/4"	21-408007000		1-1/2" X 1/2"	21-406209000		
	1"	21-408010000		1-1/2" X 1"	21-406211000		
	1-1/4"	21-408012000		2" X 1-1/2"	21-406251000		
	1-1/2"	21-408015000					
2"	21-408020000						
45° SLIP ELBOW 	1/2"	21-417005000		1/2"	21-407005000		
	3/4"	21-417007000		3/4"	21-407007000		
	1"	21-417010000		1"	21-407010000		
	1-1/4"	21-417012000		1-1/4"	21-407012000		
	1-1/2"	21-417015000		1-1/2"	21-407015000		
2"	21-417020000		2"	21-407020000			
2-1/2"	21-417025000		2-1/2"	21-407025000			

TITAN INDUSTRIES, INC.
a world of products for the world of water

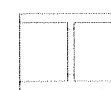
*Prices are subject to change without notice.
Returns are subject to a restock fee.
Special Orders are non-returnable.*

SCHEDULE 40 PVC FITTINGS

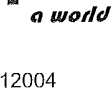
Item	Size	Part No.	List Price	Item	Size	Part No.	List Price	
45° SLIP ELBOW CONT. 	3"	21-417030000		SIDE OUTLET ELBOW (SLIPXFIPT) 	1/2"	21-414005000		
	4"	21-417040000			3/4"	21-414007000		
	5"	21-417050000			3/4"X3/4"X1/2"	21-414101000		
	6"	21-417060000			1"X1"X1/2"	21-414130000		
	8"	21-417080000						
	10"	21-417100000						
90° STREET ELBOW (SPIGXSLIP) 	1/2"	21-409005000		30° SLIP ELBOW 	2"	21-415020F00		
	3/4"	21-409007000			3"	21-415030F00		
	1"	21-409010000			4"	21-415040F00		
	1-1/4"	21-409012000			6"	21-415060F00		
	1-1/2"	21-409015000			8"	21-415080F00		
	2"	21-409020000			10"	21-415100F00		
90° STREET ELBOW (MIPTXSLIP) 	1/2"	21-410005000			15° SLIP ELBOW 	12"	21-415120F00	
	3/4"	21-410007000				14"	21-415140F00	
	1"	21-410010000				16"	21-415160F00	
	1-1/4"	21-410012000						
	1-1/2"	21-410015000						
	2"	21-410020000						
90° STREET ELBOW (SPIGXFIPT)	3/4" X 1/2"	21-410101000		SLIP CROSS 		1/2"	21-420005000	
						3/4"	21-420007000	
						1"	21-420010000	
						1-1/4"	21-420012000	
			1-1/2"		21-420015000			
			2"		21-420020000			
90° STREET ELBOW (MIPTXFIPT) 	1/2"	21-411005L00		SLIP COUPLER 	2-1/2"	21-420025000		
	3/4"	21-411007L00			3"	21-420030000		
	1-1/4"	21-411012L00			4"	21-420040000		
	1-1/2"	21-411015L00			6"	21-420060F00		
90° STREET ELBOW (MIPTXFIPT) 	1/2"	21-412005000			SLIP COUPLER 	3/8"	21-429003000	
	3/4"	21-412007000				1/2"	21-429005000	
	1"	21-412010000				3/4"	21-429007000	
	1-1/4"	21-412012000				1"	21-429010000	
	1-1/2"	21-412015000		1-1/4"		21-429012000		
	2"	21-412020000		1-1/2"		21-429015000		
11-1/4° SLIP ELBOW 	2"	21-411020000		SLIP COUPLER 		2"	21-429020000	
	3"	21-411030000				2-1/2"	21-429025000	
	4"	21-411040000				3"	21-429030000	
	6"	21-411060F00				4"	21-429040000	
	8"	21-411080F00			4-1/2"	21-429045F00		
	10"	21-411100F00			5"	21-429050000		
SIDE OUTLET SLIP ELBOW 	1/2"	21-413005000			6"	21-429060000		
					8"	21-429080000		
					10"	21-429100F00		









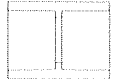

Prices are subject to change without notice.

Returns are subject to a restock fee.

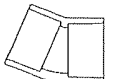
Special Orders are non-returnable.

TITAN INDUSTRIES, INC.
a world of products for the world of water

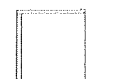



SCHEDULE 40 PVC FITTINGS

Item	Size	Part No.	List Price	Item	Size	Part No.	List Price
SLIP COUPLER CONT. 	12"	21-429120F00		RISER EXTENSION (FIPTXMIPT) 	1/2"	21-434005000	
	14"	21-429140F00			3/4"	21-434007000	
	16"	21-429160F00			1"	21-434010000	
REDUCING SLIP COUPLER 	3/4" X 1/2"	21-429101000		FEMALE ADAPTER (SLIPXFIPT) 	3/8"	21-435003000	
	1" X 3/4"	21-429131000			1/2"	21-435005000	
	1-1/4" X 1"	21-429168000			3/4"	21-435007000	
	1-1/2" X 1-1/4"	21-429212000			1"	21-435010000	
	2" X 1-1/2"	21-429251000			1-1/4"	21-435012000	
	3" X 2"	21-429338000			1-1/2"	21-435015000	
	3" X 2-1/2"	21-429340F00			2"	21-435020000	
	4" X 3"	21-429422000			2-1/2"	21-435025000	
	5" X 4-1/2"	21-429491F00			3"	21-435030000	
	6" X 4"	21-429532000			4"	21-435040000	
8" X 6"	21-429585000		5"	21-435050000			
14" X 12"	21-429702F00		6"	21-435060000			
8"			8"	21-435080000			
22-1/2° SLIP ELBOW 	2"	21-416020000		REDUCING FEMALE ADAPTER (SLIPXFIPT) 	1/2" X 1/4"	21-435072000	
	3"	21-416030000			1/2" X 3/8"	21-435073000	
	4"	21-416040000			1/2" X 3/4"	21-435074000	
	6"	21-416060F00			3/4" X 1/2"	21-435101000	
	8"	21-416080F00			3/4" X 1"	21-435102000	
	10"	21-416100F00			1" X 3/4"	21-435131000	
16"	21-416160F00		1" X 1-1/2"	21-435133000			
COUPLER (FIPTXFIPT) 	1/2"	21-430005000		MALE ADAPTER (MIPTXSLIP) 	3/8"	21-436003000	
	1/2" GRAY	21-430005G00			1/2"	21-436005000	
	3/4"	21-430007000			3/4"	21-436007000	
	1"	21-430010000			1"	21-436010000	
IPS TO PIP ADAPTER (SPIGXSLIP) 	6"	21-431060000		1-1/4"	21-436012000		
	8"	21-431080000			1-1/2"	21-436015000	
REDUCING MALE ADAPTER (MIPTXSLIP) 				2"	21-436020000		
				2-1/2"	21-436025000		
				3"	21-436030000		
				4"	21-436040000		
				5"	21-436050000		
				6"	21-436060000		
				8"	21-436080000		
				1/2" X 3/8"	21-436073000		
				1/2" X 3/4"	21-436074000		
				3/4" X 1/2"	21-436101000		
3/4" X 1"	21-436102000						
1" X 3/4"	21-436131000						
1" X 1-1/4"	21-436132000						
1-1/4" X 1"	21-436168000						
1-1/4" X 1-1/2"	21-436169000						
1-1/2" X 1-1/4"	21-436212000						
1-1/2" X 2"	21-436213000						
PIP SLIP X IPS MALE THREAD ADAPTER	8"	21-432080000					

TITAN INDUSTRIES, INC.
a world of products for the world of water

*Prices are subject to change without notice.
Returns are subject to a restock fee.
Special Orders are non-returnable.*

SCHEDULE 40 PVC FITTINGS

Item	Size	Part No.	List Price	Item	Size	Part No.	List Price
REDUCING MALE ADAPTER (MIPTXSLIP) 	2" X 1-1/2"	21-436251000		REDUCER BUSHING (SPIGXFIPT) 	1/2" X 1/8"	21-438071000	
	2" X 2-1/2"	21-436252000			1/2" X 1/4"	21-438072000	
	2-1/2" X 3"	21-436294000			1/2" X 3/8"	21-438073000	
	2-1/2" X 4"	21-436296000			3/4" X 1/4"	21-438098000	
3" X 4"	21-436342000	3/4" X 1/2"	21-438101000				
REDUCER BUSHING (SPIGXSLIP) 	1" X 1/2"	21-437130000	1" X 3/8"		21-438129000		
	1" X 3/4"	21-437131000	1" X 1/2"		21-438130000		
	1-1/4" X 1/2"	21-437166000	1" X 3/4"		21-438131000		
	1-1/4" X 3/4"	21-437167000	1-1/4" X 1/2"		21-438166000		
	1-1/4" X 1"	21-437168000	1-1/4" X 3/4"		21-438167000		
	1-1/2" X 1/2"	21-437209000	1-1/4" X 1"		21-438168000		
	1-1/2" X 3/4"	21-437210000	1-1/2" X 1/4"		21-438207000		
	1-1/2" X 1"	21-437211000	1-1/2" X 1/2"		21-438209000		
	1-1/2" X 1-1/4"	21-437212000	1-1/2" X 3/4"		21-438210000		
	2" X 1/2"	21-437247000	1-1/2" X 1"		21-438211000		
	2" X 3/4"	21-437248000	1-1/2" X 1-1/4"		21-438212000		
	2" X 1"	21-437249000	2" X 1/4"	21-438245000			
	2" X 1-1/4"	21-437250000	2" X 1/2"	21-438247000			
	2" X 1-1/2"	21-437251000	2" X 3/4"	21-438248000			
	2-1/2" X 1/2"	21-437287000	2" X 1"	21-438249000			
	2-1/2" X 3/4"	21-437288000	2" X 1-1/4"	21-438250000			
	2-1/2" X 1"	21-437289000	2" X 1-1/2"	21-438251000			
	2-1/2" X 1-1/4"	21-437290000	2-1/2" X 1/2"	21-438287000			
	2-1/2" X 1-1/2"	21-437291000	2-1/2" X 3/4"	21-438288000			
	2-1/2" X 2"	21-437292000	2-1/2" X 1"	21-438289000			
	3" X 3/4"	21-437334000	2-1/2" X 1-1/4"	21-438290000			
	3" X 1"	21-437335000	2-1/2" X 1-1/2"	21-438291000			
	3" X 1-1/4"	21-437336000	2-1/2" X 2"	21-438292000			
	3" X 1-1/2"	21-437337000	3" X 3/4"	21-438334000			
	3" X 2"	21-437338000	3" X 1"	21-438335000			
	3" X 2-1/2"	21-437339000	3" X 1-1/4"	21-438336000			
	4" X 2"	21-437420000	3" X 1-1/2"	21-438337000			
	4" X 2-1/2"	21-437421000	3" X 2"	21-438338000			
	4" X 3"	21-437422000	3" X 2-1/2"	21-438339000			
	5" X 2"	21-437486000	4" X 2"	21-438420000			
	5" X 3"	21-437488000	4" X 2-1/2"	21-438421000			
	5" X 4"	21-437490000	4" X 3"	21-438422000			
6" X 2"	21-437528000	5" X 3"	21-438488000				
6" X 3"	21-437530000	5" X 4"	21-438490000				
6" X 4"	21-437532000	6" X 2"	21-438528000				
6" X 5"	21-437534000	6" X 3"	21-438530000				
8" X 4"	21-437582000	6" X 4"	21-438532000				
8" X 6"	21-437585000	6" X 5"	21-438534000				
10" X 6"	21-437626000						
10" X 8"	21-437628000						
12" X 8"	21-437668000						
12" X 10"	21-437670000						
				IPT ADAPTER (MIPTXFIPT) 	3/8"	21-446003000	
					1-1/4"	21-446012000	
					3/8" X 1/2"	21-446053000	
				1/2" X 3/4"	21-446074000		











Prices are subject to change without notice.

Returns are subject to a restock fee.

Special Orders are non-returnable.

TITAN INDUSTRIES, INC.
a world of products for the world of water









SCHEDULE 40 PVC FITTINGS

Item	Size	Part No.	List Price	Item	Size	Part No.	List Price	
	3/8"	21-447003000			REDUCER	1-1/4" X 1"	21-439168000	
	1/2"	21-447005000			BUSHING	1-1/2" X 1/2"	21-439209000	
	3/4"	21-447007000			(MIPTXFIPT)	1-1/2" X 3/4"	21-439210000	
	1"	21-447010000			CONT.	1-1/2" X 1"	21-439211000	
	1-1/4"	21-447012000				1-1/2" X 1-1/4"	21-439212000	
	1-1/2"	21-447015000				2" X 1"	21-439249000	
	2"	21-447020000				2" X 1-1/4"	21-439250000	
	2-1/2"	21-447025000				2" X 1-1/2"	21-439251000	
	3"	21-447030000				2-1/2" X 2"	21-439292000	
	4"	21-447040000				3" X 2"	21-439338000	
	4-1/2"	21-447045F00				3" X 2-1/2"	21-439339000	
	5"	21-447050000						
	6"	21-447060000						
	8"	21-447080000						
	10"	21-447100F00						
	12"	21-447120F00						
	14"	21-447140F00						
16"	21-447160F00							
18"	21-447180F00							
24"	21-447240F00							
	3/8"	21-448003000			FIPT UNION	1/2"	21-458005000	
	1/2"	21-448005000			W/BUNA-N	3/4"	21-458007000	
	3/4"	21-448007000			O-RING SEAL	1"	21-458010000	
	1"	21-448010000				1-1/4"	21-458012000	
	1-1/4"	21-448012000				1-1/2"	21-458015000	
	1-1/2"	21-448015000				2"	21-458020000	
	2"	21-448020000						
	2-1/2"	21-448025000						
	3"	21-448030000						
	4"	21-448040000						
	5"	21-448050000						
6"	21-448060000							
	3/8"	21-449003000			TRANSITION UNION	1"	21-459010BR0	
	1/2"	21-449005000			W/BUNA	1-1/4"	21-459012BR0	
	3/4"	21-449007000			O-RING	1-1/2"	21-459015BR0	
	1"	21-449010000				2"	21-459020BR0	
	1-1/4"	21-449012000						
	1-1/2"	21-449015000						
	2"	21-449020000						
	2-1/2"	21-449025000						
	3"	21-449030000						
4"	21-449040000							
	3/8" X 1/4"	21-439052000			SNAP-ON SADDLE SLIP	1"	21-463010000	
	1/2" X 1/4"	21-439072000				1-1/4"	21-463012000	
	1/2" X 3/8"	21-439073000				1-1/2"	21-463015000	
	3/4" X 1/4"	21-439098000				2"	21-463020000	
	3/4" X 3/8"	21-439099000						
	3/4" X 1/2"	21-439101000						
	1" X 1/2"	21-439130000						
	1" X 3/4"	21-439131000						
	1-1/4" X 1/2"	21-439166000						
	1-1/4" X 3/4"	21-439167000						
	2-1/2" X 3/4"	21-463288000			SADDLE SLIP	2-1/2" X 3/4"	21-463288000	
	3" X 1-1/4"	21-463336000				3" X 1-1/4"	21-463336000	
	3" X 1-1/2"	21-463337000				3" X 1-1/2"	21-463337000	
	3" X 2"	21-463338000				3" X 2"	21-463338000	
	4" X 1-1/4"	21-463418000				4" X 1-1/4"	21-463418000	
	4" X 1-1/2"	21-463419000				4" X 1-1/2"	21-463419000	
	4" X 2"	21-463420000				4" X 2"	21-463420000	
	5" X 1-1/2"	21-463485000				5" X 1-1/2"	21-463485000	
5" X 2"	21-463486000			5" X 2"	21-463486000			
6" X 1-1/4"	21-463526000			6" X 1-1/4"	21-463526000			

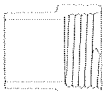
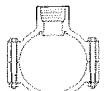
TITAN INDUSTRIES, INC.
a world of products for the world of water

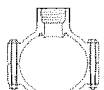
*Prices are subject to change without notice.
Returns are subject to a restock fee.
Special Orders are non-returnable.*



SCHEDULE 40 PVC FITTINGS

Item	Size	Part No.	List Price	Item	Size	Part No.	List Price
SADDLE SLIP CONT. 	6" X 1-1/2"	21-463527000		MANIFOLD TEE 	1" (SPIGXSLIPXFIPT)	21-477010000	
	6" X 2"	21-463528000					
	6" X 4"	21-463532000					
	10" X 2"	21-463623000					
	10" X 4"	21-463624000					
FIPT SADDLE 	1/2"	21-464005000		SPIG FEMALE ADAPTER 	3/4"	21-478007000	
	3/4"	21-464007000			1"	21-478010000	
	3/4" X 1/2"	21-464101000			1-1/4"	21-478012000	
	1" X 1/2"	21-464130000			1-1/2"	21-478015000	
	1-1/2" X 3/4"	21-464210000			2"	21-478020000	
	2-1/2" X 3/4"	21-464288000			3"	21-478030000	
	3" X 1-1/2"	21-464337000			4"	21-478040000	
	4" X 1-1/2"	21-464419000					
CLAMP SADDLE W/ BUNA O-RING 	2" X 1"	21-467249SR0		DEEP SOCKET SLIP COUPLER 	1/2"	21-479005N00	
					1-1/2"	21-479015000	
					2"	21-479020000	
					2-1/2"	21-479025000	
					3"	21-479030000	
WEDGE SADDLE FIPT W/EPDM O-RING 	2" X 1-1/4"	21-467E250SR		COUNTER SUNK PLUG (SPIG)	3/4"	21-449007CS0	
SLIP WYE 	2"	21-475020000		PLUG (MIPT) 	3/8"	21-450003000	
	3"	21-475030000			1/2"	21-450005000	
	4"	21-475040000			3/4"	21-450007000	
	6"	21-475060000			1"	21-450010000	
	10"	21-475100F00			1-1/4"	21-450012000	
REDUCING SLIP WYE	6" X 6" X 4"	21-475532000		1-1/2"	21-450015000		
				2"	21-450020000		
				2-1/2"	21-450025000		
				3"	21-450030000		
				4"	21-450040000		
MANIFOLD TEE 	1" (SPIGXSLIPXMIPT)	21-476010000		INSERT ADAPTER (INSXSPIG) 	3/4"	21-460007000	
					1"	21-460010000	
					1-1/4"	21-460012000	
					1-1/2"	21-460015000	
					2"	21-460020000	

TITAN INDUSTRIES, INC.
a world of products for the world of water

*Prices are subject to change without notice.
Returns are subject to a restock fee.
Special Orders are non-returnable.*

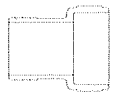

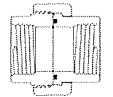



SCHEDULE 40 PVC FITTINGS

Item	Size	Part No.	List Price	Item	Size	Part No.	List Price	
SLIP ADAPTER (INSXIPS) 	1/2"	21-474005000		FEMALE ADAPTER (SLIPXFIPT) 	1/2"	21-D43500500		
	3/4"	21-474007000			3/4"	21-D43500700		
	1"	21-474010000						
	1-1/4"	21-474012000						
	1-1/2"	21-474015000						
	2"	21-474020000						
	3"	21-474030000						
	4"	21-474040000						
SLIP UNION W/EPDM O-RING SEAL 	1/2"	21-497005000		SDR21 TEE (GXGXG)	2"	21-H11222000		
	3/4"	21-497007000			2-1/2"	21-H11225500		
	1"	21-497010000				3"	21-H11233000	
	1-1/4"	21-497012000		SDR21 REDUCING (GXG)	2" X 1-1/2"	21-H11621500		
	2"	21-497020000			2-1/2" X 2"	21-H11625200		
					3" X 2"	21-H11632100		
FIPT UNION W/EPDM O-RING SEAL 	1/2"	21-498005000		SDR21 REDUCING (MIPTXG)	3" X 2"	21-H11632000		
	3/4"	21-498007000						
	1"	21-498010000		SDR21 90° ELBOW (GXG)	2"	21-H11802000		
	1-1/4"	21-498012000			2-1/2"	21-H11802500		
	1-1/2"	21-498015000			3"	21-H11803000		
	2"	21-498020000						
TRANSITION UNION W/EPDM O-RING SEAL	1"	21-499010BR0		SDR21 45° ELBOW (GXG)	2"	21-H12202000		
	1-1/4"	21-499012BR0			2-1/2"	21-H12202500		
	1-1/2"	21-499015BR0		SDR21 REDUCING TEE (GXGXFIPT)	2-1/2" X 2-1/2" X 1-1/2"	21-H15125600		
	2"	21-499020BR0			3" X 3" X 1-1/2"	21-H15130600		
DAWN SADDLE	1-1/4" X 1/2"	21-DST11/4X1		LIGHT SLIP CAP (NOT PRESSURE RATED)	4"	21-WCEC4000		
	1-1/4" X 3/4"	21-DST11/4X3			4-1/2"	21-WCEC4500		
	1" X 1/2"	21-DST1X1/20			5"	21-WCEC5000		
	1-1/2" X 1/2"	21-PE2090000			6"	21-WCEC6000		
					6-1/4"	21-WCEC6120		
					8"	21-WCEC8000		
REDUCING SLIP TEE	3/4" X 3/4" X 1/2"	21-D40110100						
	1" X 1" X 1/2"	21-D40113000						
	1-1/4" X 1-1/4" X 1"	21-D40116600						
	1-1/2" X 1-1/2" X 1"	21-D40120900						
	2" X 2" X 1/2"	21-D40124700						
REDUCING 90° SLIP ELBOW	3/4" X 1/2"	21-D40610100						
	1" X 1/2"	21-D40613000						
	1-1/4" X 1/2"	21-D40616600						

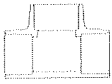
TITAN INDUSTRIES, INC.
a world of products for the world of water

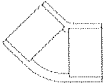
*Prices are subject to change without notice.
Returns are subject to a restock fee.
Special Orders are non-returnable.*

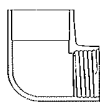
SCHEDULE 80 PVC FITTINGS

Item	Size	Part No.	List Price	Item	Size	Part No.	List Price
	1/2"	23-801005000			2"	23-816020000	
	3/4"	23-801007000			3"	23-816030000	
	1"	23-801010000			4"	23-816040000	
	1-1/4"	23-801012000			6"	23-816060F00	
	1-1/2"	23-801015000					
	2"	23-801020000					
	2-1/2"	23-801025000					
	3"	23-801030000					
	4"	23-801040000					
	6"	23-801060000					
8"	23-801080000						
10"	23-801100000						
	3/4"X3/4"X1/2"	23-801101000			1/2"	23-817005000	
	1"X1"X1/2"	23-801130000			3/4"	23-817007000	
	1"X1"X3/4"	23-801131000			1"	23-817010000	
	1-1/4"X1"X3/4"	23-801157000			1-1/4"	23-817012000	
	1-1/4"X1-1/4"X1"	23-801168000			1-1/2"	23-817015000	
	1-1/2"X1-1/4"X1"	23-801202000			2"	23-817020000	
	1-1/2"X1-1/2"X3/4"	23-801210000			2-1/2"	23-817025000	
	1-1/2"X1-1/2"X1"	23-801211000			3"	23-817030000	
	1-1/2"X1-1/2"X1-1/4"	23-801212000			4"	23-817040000	
	2"X2"X1/2"	23-801247000			6"	23-817060000	
	2"X2"X3/4"	23-801248000			8"	23-817080000	
	2"X2"X1"	23-801249000			16"	23-817160F00	
	2"X2"X1-1/2"	23-801251000					
	3"X3"X2"	23-801338000					
	4"X4"X2"	23-801420000					
	4"X4"X3"	23-801422000					
6"X6"X2"	23-801528F00						
6"X6"X3"	23-801530000						
6"X6"X4"	23-801532000						
8"X8"X4"	23-801582000						
8"X8"X6"	23-801585000						
16"X16"X10"	23-801760F00						
				1"	23-819010000		
				1-1/4"	23-819012000		
				1-1/2"	23-819015000		
				2"	23-819020000		
				2-1/2"	23-819025000		
				1/2"	23-806005000		
				3/4"	23-806007000		
				1"	23-806010000		
				1-1/4"	23-806012000		
				1-1/2"	23-806015000		
				2"	23-806020000		
				2-1/2"	23-806025000		
				3"	23-806030000		
				4"	23-806040000		
				6"	23-806060000		
				8"	23-806080000		
			14"	23-806140F00			
			16"	23-806160F00			
				1/2"	23-807005000		
				3/4"	23-807007000		
				1"	23-807010000		
				1-1/4"	23-807012000		
				1-1/2"	23-807015000		
				2"	23-807020000		
	1/2"	23-802005000					
	3/4"	23-802007000					
	1"	23-802010000					
	2"	23-802020000					
	2"X2"X1-1/2"	23-802251000					
	1/4"	23-805002000					
	3/8"	23-805003000					
	1/2"	23-805005000					
	3/4"	23-805007000					
	1"	23-805010000					
	1-1/4"	23-805012000					
	1-1/2"	23-805015000					
	2"	23-805020000					
	2-1/2"	23-805025000					
	3"	23-805030000					
4"	23-805040000						







Prices are subject to change without notice.

Returns are subject to a restock fee.

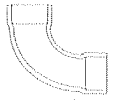
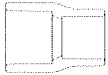
Special Orders are non-returnable.

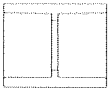
TITAN INDUSTRIES, INC.
a world of products for the world of water

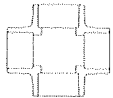
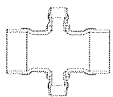
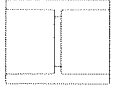

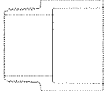

SCHEDULE 80 PVC FITTINGS

Item	Size	Part No.	List Price	Item	Size	Part No.	List Price	
LONG SWEEP 90° SLIP ELBOW 	4"	23-806040LSF		REDUCING COUPLER 	2"X1"	23-829249000		
					4"X2"	23-829420000		
					4"X3"	23-829422000		
					6"X4"	23-829532000		
90° ELBOW (FIPTXFIPT) 	1/2"	23-808005000		DEEP SOCKET SLIP COUPLER 	1"	23-829DS0100		
	3/4"	23-808007000			1-1/2"	23-829DS0150		
	1"	23-808010000			2"	23-829DS0200		
	1-1/4"	23-808012000		COUPLER (FIPTXFIPT) 	1/4"	23-830002000		
	1-1/2"	23-808015000			3/8"	23-830003000		
	2"	23-808020000			1/2"	23-830005000		
	2-1/2"	23-808025000			3/4"	23-830007000		
3"	23-808030000		1"	23-830010000				
4"	23-808040000		1-1/4"	23-830012000				
4"	23-808040000		1-1/2"	23-830015000				
SLIP CROSS 	3/4"	23-820007000		2"	23-830020000			
	1"	23-820010000		2-1/2"	23-820025000			
	1-1/4"	23-820012000		3"	23-820030000			
	1-1/2"	23-820015000		4"	23-820040000			
	2"	23-820020000		REDUCING CROSS 	6" X 3"	23-820530F00		
	2-1/2"	23-820025000			SLIP COUPLER 	1/4"	23-829002000	
	3"	23-820030000				3/8"	23-829003000	
4"	23-820040000		1/2"	23-829005000				
5"	23-829050F00		3/4"	23-829007000				
6"	23-829060000		1"	23-829010000				
8"	23-829080000		1-1/4"	23-829012000				
10"	23-829100F00		1-1/2"	23-829015000				
12"	23-829120F00		2"	23-829020000				
				2-1/2"	23-829025000			
				3"	23-829030000			
				4"	23-829040000			
				5"	23-829050F00			
				6"	23-829060000			
				8"	23-829080000			
				10"	23-829100F00			
				12"	23-829120F00			
				FEMALE ADAPTER (SLIPXFIPT) 	1/4"	23-835002000		
					3/8"	23-835003000		
					1/2"	23-835005000		
					3/4"	23-835007000		
					1"	23-835010000		
					1-1/4"	23-835012000		
				1-1/2"	23-835015000			
				2"	23-835020000			
				2-1/2"	23-835025000			
				3"	23-835030000			
				4"	23-835040000			
				6"	23-835060000			
				MALE ADAPTER (MIPTXSLIP) 	1/2"	23-836005000		
					3/4"	23-836007000		
					1"	23-836010000		
					1-1/4"	23-836012000		
					1-1/2"	23-836015000		
					2"	23-836020000		
				2-1/2"	23-836025000			
				3"	23-836030000			
				4"	23-836040000			
				5"	23-836050000			
				6"	23-836060000			

TITAN INDUSTRIES, INC.
a world of products for the world of water

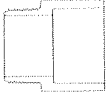
*Prices are subject to change without notice.
Returns are subject to a restock fee.
Special Orders are non-returnable.*

SCHEDULE 80 PVC FITTINGS

Item	Size	Part No.	List Price	Item	Size	Part No.	List Price
DP SOCKET MALE ADAPTER 	2"	23-836020DS0		REDUCER BUSHING (SPIGXFIPT) CONT. 	2" X 1/2"	23-838247000	
	2-1/2" (MIPTXSLIP)	23-836025DS0			2" X 3/4"	23-838248000	
REDUCER BUSHING (SPIGXSLIP) 	3/8"X1/4"	23-837052000		2" X 1"	23-838249000		
	1/2"X1/4"	23-837072000		2" X 1-1/4"	23-838250000		
	1/2"X3/8"	23-837073000		2" X 1-1/2"	23-838251000		
	3/4"X1/2"	23-837101000		2-1/2" X 1/2"	23-838287000		
	1"X1/2"	23-837130000		2-1/2" X 3/4"	23-838288000		
	1"X3/4"	23-837131000		2-1/2" X 1"	23-838289000		
	1-1/4"X1/2"	23-837166000		2-1/2"X1-1/4"	23-838290000		
	1-1/4"X3/4"	23-837167000		2-1/2"X1-1/2"	23-838291000		
	1-1/4"X1"	23-837168000		2-1/2" X 2"	23-838292000		
	1-1/2"X1/2"	23-837209000		3" X 3/4"	23-838334000		
	1-1/2"X3/4"	23-837210000		3" X 1"	23-838335000		
	1-1/2"X1"	23-837211000		3" X 1-1/4"	23-838336000		
	1-1/2"X1-1/4"	23-837212000		3" X 1-1/2"	23-838337000		
	2"X1/2"	23-837247000		3" X 2"	23-838338000		
	2"X3/4"	23-837248000		3" X 2-1/2"	23-838339000		
	2"X1"	23-837249000		4" X 2"	23-838420000		
	2" X 1-1/4"	23-837250000		4" X 2-1/2"	23-838421000		
	2" X 1-1/2"	23-837251000		4" X 3"	23-838422000		
	2-1/2" X 2"	23-837292000		6" X 2"	23-838528000		
	3" X 1"	23-837335000		6" X 3"	23-838530000		
	3" X 1-1/4"	23-837336000		6" X 4"	23-838532000		
	3" X 1-1/2"	23-837337000					
	3" X 2"	23-837338000					
	3" X 2-1/2"	23-837339000					
	4" X 2"	23-837420000					
	4" X 3"	23-837422000					
	6" X 2"	23-837528000					
	6" X 3"	23-837530000					
6" X 4"	23-837532000						
8" X 6"	23-837585000						
REDUCER BUSHING (MIPTXFIPT) 	3/8" X 1/4"	23-839052000					
	1/2" X 1/4"	23-839072000					
	1/2" X 3/8"	23-839073000					
	3/4" X 1/4"	23-839098000					
	3/4" X 3/8"	23-839099000					
	3/4" X 1/2"	23-839101000					
	1" X 1/4"	23-839128000					
	1" X 3/8"	23-839129000					
	1" X 1/2"	23-839130000					
	1" X 3/4"	23-839131000					
	1-1/4" X 1/2"	23-839166000					
	1-1/4" X 3/4"	23-839167000					
	1-1/4" X 1"	23-839168000					
	1-1/2" X 1/2"	23-839209000					
	1-1/2" X 3/4"	23-839210000					
	1-1/2" X 1"	23-839211000					
	1-1/2" X 1-1/4"	23-839212000					
	2" X 1/2"	23-839247000					
	2" X 3/4"	23-839248000					
	2" X 1"	23-839249000					
	2" X 1-1/4"	23-839250000					
	2" X 1-1/2"	23-839251000					
2-1/2" X 2"	23-839292000						
3" X 1-1/2"	23-839337000						
3" X 2"	23-839338000						
3" X 2-1/2"	23-839339000						
4" X 2"	23-839420000						
4" X 3"	23-839422000						
REDUCER BUSHING (SPIGXFIPT) 	3/8" X 1/4"	23-838052000					
	1/2" X 1/8"	23-838071000					
	1/2" X 1/4"	23-838072000					
	1/2" X 3/8"	23-838073000					
	3/4" X 1/4"	23-838098000					
	3/4" X 1/2"	23-838101000					
	1" X 3/8"	23-838129000					
	1" X 1/2"	23-838130000					
	1" X 3/4"	23-838131000					
	1-1/4" X 1/2"	23-838166000					
	1-1/4" X 3/4"	23-838167000					
	1-1/4" X 1"	23-838168000					
	1-1/2" X 1/2"	23-838209000					
1-1/2" X 3/4"	23-838210000						
1-1/2" X 1"	23-838211000						
1-1/2"X1-1/4"	23-838212000						









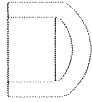

Prices are subject to change without notice.

Returns are subject to a restock fee.

Special Orders are non-returnable.

TITAN INDUSTRIES, INC.
a world of products for the world of water





SCHEDULE 80 PVC FITTINGS

Item	Size	Part No.	List Price	Item	Size	Part No.	List Price	
	1/4"	23-847002000			5"	23-851050000		
	3/8"	23-847003000			6"	23-851060000		
	1/2"	23-847005000			8"	23-851080000		
	3/4"	23-847007000						
	1"	23-847010000						
	1-1/4"	23-847012000						
	1-1/2"	23-847015000						
	2"	23-847020000						
	2-1/2"	23-847025000						
	3"	23-847030000						
	4"	23-847040000						
	6"	23-847060000						
	8"	23-847080000						
12"	23-847120F00							
	1/4"	23-848002000			2"	23-853020000		
	3/8"	23-848003000			2-1/2"	23-853025000		
	1/2"	23-848005000			3"	23-853030000		
	3/4"	23-848007000			4"	23-853040000		
	1"	23-848010000			6"	23-853060000		
	1-1/4"	23-848012000			8"	23-853080000		
	1-1/2"	23-848015000						
	2"	23-848020000						
	2-1/2"	23-848025000						
	3"	23-848030000						
4"	23-848040000							
	1"	23-849010000			6"	23-856060000		
	1-1/4"	23-849012000						
	1-1/2"	23-849015000						
	2"	23-849020000						
	1/4"	23-850002000			1/2"	23-854005000		
	3/8"	23-850003000			3/4"	23-854007000		
	1/2"	23-850005000			1"	23-854010000		
	3/4"	23-850007000			1-1/4"	23-854012000		
	1"	23-850010000			1-1/2"	23-854015000		
	1-1/4"	23-850012000			2"	23-854020000		
	1-1/2"	23-850015000			2-1/2"	23-854025000		
	2"	23-850020000			3"	23-854030000		
	2-1/2"	23-850025000			4"	23-854040000		
	3"	23-850030000			5"	23-854050000		
	4"	23-850040000			6"	23-854060000		
	5"	23-850050000			8"	23-854080000		
	6"	23-850060000			10"	23-854100000		
8"	23-850080000	12"	23-854120000					
		14"	23-854140000					
		16"	23-854160000					
	1"	23-851010000			1/2"	23-805700500		
	1-1/4"	23-851012000			3/4"	23-805700700		
	2"	23-851020000			1"	23-805701000		
	2-1/2"	23-851025000			1-1/4"	23-805701200		
	3"	23-851030000			1-1/2"	23-805701500		
	4"	23-851040000						

TITAN INDUSTRIES, INC.
a world of products for the world of water

*Prices are subject to change without notice.
Returns are subject to a restock fee.
Special Orders are non-returnable.*

SCHEDULE 80 PVC FITTINGS

Item	Size	Part No.	List Price	Item	Size	Part No.	List Price	
SLIP UNION W/VITON O-RING SEAL CONT. 	2"	23-857020000		FIPT UNION W/EPDM O-RING SEAL 	1/4"	23-898002000		
	2-1/2"	23-857025000			3/8"	23-898003000		
	3"	23-857030000			1/2"	23-898005000		
	4"	23-857040000			3/4"	23-898007000		
					1"	23-898010000		
					1-1/4"	23-898012000		
					1-1/2"	23-898015000		
					2"	23-898020000		
					3"	23-898030000		
					4"	23-898040000		
FIPT UNION W/VITON O-RING SEAL 	3/4"	23-858007000						
	1"	23-858010000						
	1-1/4"	23-858012000						
	1-1/2"	23-858015000						
	2"	23-858020000						
	4"	23-858040000						
TANK ADAPTER W/NEOPRENE GASKET (SLIPXFIPT) 	1/2"	23-871005000						
	3/4"	23-871007000						
	1"	23-871010000						
	1-1/4"	23-871012000						
	1-1/2"	23-871015000						
	2"	23-871020000						
	3"	23-871030000						
	4"	23-871040000						
6"	23-871060000							
TANK ADAPTER W/EPDM GASKET 	2" (SLIPXFIPT)	23-871E02000						
SLIP UNION W/EPDM O-RING SEAL	1/4"	23-897002000						
	3/8"	23-897003000						
	1/2"	23-897005000						
	3/4"	23-897007000						
	1"	23-897010000						
	1-1/4"	23-897012000						
	1-1/2"	23-897015000						
	2"	23-897020000						
	3"	23-897030000						
	4"	23-897040000						

TITAN INDUSTRIES, INC.
a world of products for the world of water

*Prices are subject to change without notice.
Returns are subject to a restock fee.
Special Orders are non-returnable.*

SCHEDULE 80 PVC MIPT NIPPLES

Item	Size	Part No.	List Price	Item	Size	Part No.	List Price
NIPPLE TOE	3/4"X4" 1"X4"	25-188304000 25-TOE010040		NIPPLE 1" CONT.	1"X8" 1"X10" 1"X12"	25-884080000 25-884100000 25-884120000	
CUT-OFF NIPPLE	1/2"MIPTX6" 1/2"X3/4"MIPTX6" 3/4"MIPTX6"	25-491060000 25-492060000 25-493060000		NIPPLE 1-1/4"	1-1/4"XCLOSE 1-1/4"X2" 1-1/4"X2-1/2" 1-1/4"X3" 1-1/4"X4" 1-1/4"X4-1/2" 1-1/4"X5" 1-1/4"X6" 1-1/4"X8" 1-1/4"X10" 1-1/4"X12"	25-885005000 25-885020000 25-885025000 25-885030000 25-885040000 25-885045000 25-885050000 25-885060000 25-885080000 25-885100000 25-885120000	
NIPPLE 1/4"	1/4"XCLOSE 1/4"X1-1/2" 1/4"X2" 1/4"X2-1/2" 1/4"X3" 1/4"X3-1/2" 1/4"X4" 1/4"X4-1/2" 1/4"X5" 1/4"X6" 1/4"X8"	25-880005000 25-880015000 25-880020000 25-880025000 25-880030000 25-880035000 25-880040000 25-880045000 25-880050000 25-880060000 25-880080000		NIPPLE 1-1/2"	1-1/2"XCLOSE 1-1/2"X2" 1-1/2"X2-1/2" 1-1/2"X3" 1-1/2"X3-1/2" 1-1/2"X4" 1-1/2"X4-1/2" 1-1/2"X5" 1-1/2"X6" 1-1/2"X8" 1-1/2"X10"	25-886005000 25-886020000 25-886025000 25-886030000 25-886035000 25-886040000 25-886045000 25-886050000 25-886060000 25-886080000 25-886100000	
NIPPLE 3/8"	3/8"XCLOSE	25-881005000		NIPPLE 2"	2"XCLOSE 2"X2-1/2" 2"X3" 2"X4" 2"X4-1/2" 2"X5" 2"X6" 2"X8" 2"X10" 2"X12" 2"X16" 2"X30"	25-887005000 25-887025000 25-887030000 25-887040000 25-887045000 25-887050000 25-887060000 25-887080000 25-887100000 25-887120000 25-887160000 25-887300000	
NIPPLE 1/2"	1/2"XCLOSE 1/2"X1-1/2" 1/2"X2" 1/2"X2-1/2" 1/2"X3" 1/2"X4" 1/2"X4-1/2" 1/2"X5" 1/2"X6" 1/2"X8"	25-882005000 25-882015000 25-882020000 25-882025000 25-882030000 25-882040000 25-882045000 25-882050000 25-882060000 25-882080000		NIPPLE 2-1/2"	2-1/2"XCLOSE 2-1/2"X3" 2-1/2"X3-1/2" 2-1/2"X4" 2-1/2"X4-1/2" 2-1/2"X5" 2-1/2"X6" 2-1/2"X8"	25-888005000 25-888030000 25-888035000 25-888040000 25-888045000 25-888050000 25-888060000 25-888080000	
NIPPLE 3/4"	3/4"XCLOSE 3/4"X1-1/2" 3/4"X2" 3/4"X2-1/2" 3/4"X3" 3/4"X4" 3/4"X4-1/2" 3/4"X5" 3/4"X5-1/2" 3/4"X6" 3/4"X8" 3/4"X10" 3/4"X12"	25-883005000 25-883015000 25-883020000 25-883025000 25-883030000 25-883040000 25-883045000 25-883050000 25-883055000 25-883060000 25-883080000 25-883100000 25-883120000		NIPPLE 1"	1"XCLOSE 1"X2" 1"X2-1/2" 1"X3" 1"X4" 1"X4-1/2" 1"X5" 1"X6"	25-884005000 25-884020000 25-884025000 25-884030000 25-884040000 25-884045000 25-884050000 25-884060000	

TITAN INDUSTRIES, INC.
a world of products for the world of water

*Prices are subject to change without notice.
Returns are subject to a restock fee.
Special Orders are non-returnable.*



SCHEDULE 80 PVC MIPT NIPPLES

Item	Size	Part No.	List Price	Item	Size	Part No.	List Price
NIPPLE 3"	3"XCLOSE	25-889005000					
	3"X3"	25-889030000					
	3"X4"	25-889040000					
	3"X6"	25-889060000					
	3"X8"	25-889080000					
	3"X12"	25-889120000					
NIPPLE 4"	4"XCLOSE	25-890005000					
	4"X4"	25-890040000					
	4"X6"	25-890060000					
	4"X8"	25-890080000					
	4"X12"	25-890120000					
	4"X14"	25-890140000					

TITAN INDUSTRIES, INC.
a world of products for the world of water

*Prices are subject to change without notice.
 Returns are subject to a restock fee.
 Special Orders are non-returnable.*

PVC COMPRESSION FITTINGS

Item	Size	Part No.	List Price	Item	Size	Part No.	List Price
PVC COMPRESSION COUPLER BUNA-A GASKET 	1/2"	22-011005000		REPAIR COUPLER PVC SPIGXSOC EPDM O-RING 	1/2"	22-011705000	
	3/4"	22-011007000			3/4"	22-011707000	
	1"	22-011010000			1"	22-011710000	
	1-1/4"	22-011012000			1-1/4"	22-011712000	
	1-1/2"	22-011015000			1-1/2"	22-011715000	
	2"	22-011020000			2"	22-011720000	
	2-1/2"	22-011025000			2-1/2"	22-011725000	
	3"	22-011030000			3"	22-011730000	
4"	22-011040000	4"	22-011740000				
6"	22-011060000						
THREADED COMPRESSION TEE	1/2"	22-120050000		SLIP COMPRESSION TEE	1/2"	22-121050000	
	3/4"	22-120070000			3/4"	22-121070000	
	1"	22-120100000			1"	22-121100000	
	1-1/4"	22-120120000			1-1/4"	22-121120000	
	1-1/2"	22-120150000			1-1/2"	22-121150000	
	2"	22-120200000			2"	22-121200000	
IPS COMPRESSION GASKET	1/2"	22-CGS105000		COMPRESSION CTS TEE	3/4"	22-220070000	
	3/4"	22-CGS107000			1"	22-220100000	
	1"	22-CGS110000		COMPRESSION MALE ADAPTER	3/4"	22-130070000	
	1-1/4"	22-CGS112000			1-1/4"	22-130120000	
	1-1/2"	22-CGS115000			1-1/2"	22-130150000	
	2"	22-CGS120000					
	2-1/2"	22-CGS125000					
	3"	22-CGS130000					
4"	22-CGS140000						
6"	22-CGS160000						











Certa-Lok PVC FITTINGS

Item	Size	Part No.	List Price	Item	Size	Part No.	List Price		
CERTA-LOK WELL CASING COUPLER (INCLUDING: GASKETS & SPLINES)	4.950"	33-707040000		SCH40 CERTAINTEED SOLVENT WELD COUPLER	4.500"	33-717030000			
	5.563"	33-707050000			4.950"	33-717040000			
	6.625"	33-707060000			5.563"	33-717050000			
	6.900"	33-707270000			6.625"	33-717060000			
	8.625"	33-707080000			8.625"	33-717070000			
	10.750"	33-707120000							
	12.750"	33-707090000							
	14.000"	33-707100000							
16.000"	33-707110000								
17.400"	33-707190000								
CERTA-LOK CASING & SCREEN CAP (INCLUDING: SPLINE)	4.500"	33-810610000		SDR21 COUPLER	5"	33-690810000			
	6.625"	33-810640000			SDR26 COUPLER	6"		33-690820000	
	8.625"	33-810660000				SOLVENT WELD REDUCERS		4-1/2"	33-690880000
	10.750"	33-810680000						5"X4" SDR21	33-690910000
16.000"	33-810710000		5"X4-1/2"	33-690920000					
YELOMINE REPAIR COUPLER	3"	33-742040000		FEMALE ADAPTER	8.625"	33-810820000			

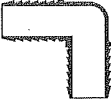
TITAN INDUSTRIES, INC.
a world of products for the world of water

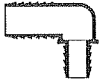
*Prices are subject to change without notice.
Returns are subject to a restock fee.
Special Orders are non-returnable.*









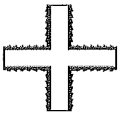

INSERT FITTINGS

Item	Size	Part No.	List Price	Item	Size	Part No.	List Price	
PVC TEE 	1/2"	42-140100500		REDUCER TEE (INSXINS XFIPT) CONT. 	1-1/2"X1-1/4"X1"	42-140220200		
	3/4"	42-140100700			1-1/2"X1-1/2"X1/2"	42-140220900		
	1"	42-140101000			1-1/2"X1-1/2"X3/4"	42-140221000		
	1-1/4"	42-140101200			1-1/2"X1-1/2"X1"	42-140221100		
	1-1/2"	42-140101500			1-1/2"X1-1/2"X1-1/2"	42-140221200		
	2"	42-140102000			2"X2"X1/2"	42-140224700		
PVC REDUCER TEE 	1/2"X1/2"X3/4"	42-140107400			2"X2"X3/4"	42-140224800		
	3/4"X1/2"X1/2"	42-140109400			2"X2"X1"	42-140224900		
	3/4"X3/4"X1/2"	42-140110100			2"X2"X1-1/2"	42-140225100		
	3/4"X3/4"X1"	42-140110200			3"X3"X1"	42-140233500		
	1"X3/4"X1/2"	42-140112400						
	1"X3/4"X3/4"	42-140112500						
	1"X1"X1/2"	42-140113000						
	1"X1"X3/4"	42-140113100						
	1"X1"X1-1/4"	42-140113200						
	1-1/4"X1"X1/2"	42-140115600						
	1-1/4"X1"X3/4"	42-140115700						
	1-1/4"X1"X1"	42-140115800						
	1-1/4"X1-1/4"X1/2"	42-140116600						
	1-1/4"X1-1/4"X3/4"	42-140116700						
	1-1/4"X1-1/4"X1"	42-140116800						
	1-1/2"X1-1/4"X3/4"	42-140120100						
	1-1/2"X1-1/4"X1"	42-140120200						
	1-1/2"X1-1/4"X1-1/4"	42-140120300						
	1-1/2"X1-1/2"X1/2"	42-140120900						
	1-1/2"X1-1/2"X3/4"	42-140121000						
	1-1/2"X1-1/2"X1"	42-140121100						
	1-1/2"X1-1/2"X1-3/4"	42-140121200						
	2"X1-1/2"X1-1/2"	42-140124100						
	2"X2"X1/2"	42-140124700						
2"X2"X3/4"	42-140124800							
2"X2"X1"	42-140124900							
2"X2"X1-1/4"	42-140125000							
2"X2"X1-1/2"	42-140125100							
PVC TEE (INSXINS XFIPT) 	1/2"	42-140200500		PVC 90° ELBOW 	1/2"	42-140600500		
	3/4"	42-140200700			3/4"	42-140600700		
	1"	42-140201000			1"	42-140601000		
	1-1/4"	42-140201200			1-1/4"	42-140601200		
	1-1/2"	42-140201500			1-1/2"	42-140601500		
	2"	42-140202000			2"	42-140602000		
PVC REDUCER TEE (INSXINS XFIPT) 	1/2"	42-140209400		PVC 90° REDUCING ELBOW 	3/4"X1/2"	42-140610100		
	3/4"X3/4"X1/2"	42-140210100			1"X3/4"	42-140613100		
	1"X3/4"X1/2"	42-140212400			1-1/4"X1"	42-140616800		
	1"X3/4"X3/4"	42-140212500			1-1/2"X1-1/4"	42-140621200		
	1"X1"X1/2"	42-140213000			2"X1-1/2"	42-140625100		
	1"X1"X3/4"	42-140213100						
	1-1/4"X1"X1/2"	42-140215600		PVC 90° ELBOW (INSXFIPT) 	1/2"	42-140700500		
	1-1/4"X1"X3/4"	42-140215700			3/4"	42-140700700		
	1-1/4"X1-1/4"X1/2"	42-140216600			1"	42-140701000		
	1-1/4"X1-1/4"X3/4"	42-140216700			1-1/4"	42-140701200		
	1-1/4"X1-1/4"X1"	42-140216800			1-1/2"	42-140701500		
	1-1/2"X1-1/4"X1/2"	42-140219900			2"	42-140702000		
	PVC REDUCING ELBOW (INSXFIPT) 	3/4"X1/2"	42-140710100		PVC 90° REDUCING ELBOW (INSXFIPT) 	1"X1/2"	42-140713000	
		1"X3/4"X1/2"	42-140713100			1"X3/4"	42-140716600	
		1"X3/4"X3/4"	42-140716700			1-1/4"X1/2"	42-140716700	
		1"X1"X1/2"	42-140716800			1-1/4"X3/4"	42-140716700	
		1"X1"X3/4"	42-140721100			1-1/4"X1"	42-140716800	
		1-1/4"X1"X1/2"	42-140721200			1-1/2"X1"	42-140721100	
		1-1/4"X1"X3/4"	42-140725100			1-1/2"X1-1/4"	42-140721200	
		1-1/4"X1-1/4"X1/2"				2"X1-1/2"	42-140725100	
		1-1/4"X1-1/4"X3/4"						
		1-1/4"X1-1/4"X1"						
		1-1/2"X1-1/4"X1/2"						

TITAN INDUSTRIES, INC.
a world of products for the world of water

*Prices are subject to change without notice.
Returns are subject to a restock fee.
Special Orders are non-returnable.*





INSERT FITTINGS

Item	Size	Part No.	List Price	Item	Size	Part No.	List Price	
PVC 90° ELBOW (INXMIPT) 	1/2"	42-141300500		PVC REDUCING MALE ADAPTER (MIPTXINS) 	1/2"X3/4"	42-143607400		
	3/4"	42-141300700			3/4"X1/2"	42-143610100		
	1"	42-141301000			3/4"X1"	42-143610200		
	1-1/4"	42-141301200			1"X3/4"	42-143613100		
	1-1/2"	42-141301500			1"X1-1/4"	42-143613200		
2"	42-141302000		1"X1-1/2"		42-143613300			
CROSS 	3/4"	42-142000700			1-1/4"X3/4"	42-143616700		
	1"	42-142001000			1-1/4"X1"	42-143616800		
PVC COUPLER 	1/2"	42-142900500			ADAPTER 	1-1/2"X1-1/2"X1-1/2"	42-143620400	
	3/4"	42-142900700				POOL MIPTXHOSE ID		
	1"	42-142901000			3/4" (ML THRD)XINS)	42-1436007M0		
	1-1/4"	42-142901200			HOSE MALE THXINS			
	1-1/2"	42-142901500			REDUCING HOSE MALE ADAPTER 	3/4"X1/2"	42-1436101M0	
	2"	42-142902000				3/4"X1"	42-1436102M0	
	2-1/2"	42-142902500						
	3"	42-142903000						
PVC REDUCING COUPLER 	4"	42-142904000		PVC PLUG 	1/2"	42-144900500		
	3/4"X1/2"	42-142910100			3/4"	42-144900700		
	1"X1/2"	42-142913000			1"	42-144901000		
	1"X3/4"	42-142913100			1-1/4"	42-144901200		
	1-1/4"X3/4"	42-142916700			1-1/2"	42-144901500		
	1-1/4"X1"	42-142916800			2"	42-144902000		
	1-1/2"X3/4"	42-142921000		MALE ADAPTER 	1"ZINC PLATED	42-S12100000		
	1-1/2"X1"	42-142921100						
1-1/2"X1-1/4"	42-142921200		STEEL COUPLER	1/2"	42-SCP050000			
2"X1"	42-142924900			3/4"	42-SCP075000			
2"X1-1/4"	42-142925000			1"	42-SCP100000			
2"X1-1/2"	42-142925100			1-1/4"	42-SCP125000			
				1-1/2"	42-SCP150000			
PVC FEMALE ADAPTER (FIPTXINS) 				2"	42-SCP200000			
	1/2"	42-143500500		STEEL MALE ADAPTER	1/2"	42-SMA050000		
	3/4"	42-143500700			3/4"	42-SMA075000		
	1"	42-143501000			1"	42-SMA100000		
	1-1/4"	42-143501200			1-1/4"	42-SMA125000		
1-1/2"	42-143501500		1-1/2"		42-SMA150000			
PVC MALE ADAPTER (MIPTXINS) 	2"	42-143502000		2"	42-SMA200000			
	1/2"	42-143600500		3"	42-SMA300000			
	3/4"	42-143600700		4"	42-SMA400000			
	1"	42-143601000		1" W/EYELET	42-SMAEYE100			
	1-1/4"	42-143601200		1"X6-1/2" W/EYELET	42-SMAEYE165			
	1-1/2"	42-143601500						
	2"	42-143602000						
	2-1/2"	42-143602500						
3"	42-143603000							
4"	42-143604000							

TITAN INDUSTRIES, INC.
a world of products for the world of water

*Prices are subject to change without notice.
Returns are subject to a restock fee.
Special Orders are non-returnable.*

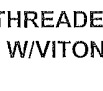
PVC VALVES

Item	Size	Part No.	List Price	Item	Size	Part No.	List Price
TRUE UNION SOCKET BALL VALVE 	3"	28-182203000		SOCKET GATE VALVE 	1"	28-201201000	
	4"	28-182204000			1-1/4"	28-201201200	
	W/EPDM O-RING SEAL				2"	28-201202000	
			W/BUNA-N O-RING SEAL				
TRUE UNION 2000 THREAD BALL VALVE	2"	28-3621020SR		COMPACT BALL VALVE THREADED 	1/2" 3/4" 1" 1-1/4" 1-1/2" 2"	28-212100500 28-212100700 28-212101000 28-212101200 28-212101500 28-212102000	
TRUE UNION 2000 SOCKET BALL VALVE	2"	28-3622020000			W/EPDM O-RING SEAL		
TRUE UNION BALL CHECK VALVE	1"	28-223901000		COMPACT BALL VALVE THREADED W/VITON 	1/2" O-RING SEAL 3/4" O-RING SEAL 1" 1-1/4" 1-1/2" 2"	28-213100500 28-213100700 28-213101000 28-213101200 28-213101500 28-213102000	
TRUE UNION BALL VALVE W/EPDM	1/2"	28-232900500		SOCKET COMPACT BALL VALVE	1-1/4"	28-212201200	
	3/4"	28-232900700			W/EPDM O-RING SEAL		
	1"	28-232901000		WHITE SINGLE ENTRY BALL VALVE W/BUNA-N 	1/2" 3/4" 1" 1-1/4" 1-1/2" 2" 3" 4"	28-2411005W0 28-2411007W0 28-2411010W0 28-2411012W0 28-2411015W0 28-2411020W0 28-2411030W0 28-2411040W0	
	1-1/4"	28-232901200		GRAY SINGLE ENTRY BALL VALVE W/BUNA-N	1/2" 3/4" 1" 1-1/4" 1-1/2" 2" 3" 4"	28-2411005G0 28-2411007G0 28-2411010G0 28-2411012G0 28-2411015G0 28-2411020G0 28-2411030G0 28-2411040G0	
	1-1/2"	28-232901500		SOCKET SINGLE ENTRY BALL VALVE	2" GRAY 2" WHITE 4" WHITE	28-2412020G0 28-2412020W0 28-2412040W0	
	2"	28-232902000					
TRUE UNION BALL VALVE W/VITON	2-1/2" THRD	28-232102500					
	3" THRD	28-232103000					
	4" THRD	28-232104000					
	1/2"	28-233900500					
	3/4"	28-233900700					
	1"	28-233901000					
BUTTERFLY VALVE	6"	28-251311060					
	W/BUNA-N O-RING						
FOOT VALVE SCREEN	1"	28-FVS010000					

TITAN INDUSTRIES, INC.
a world of products for the world of water

Prices are subject to change without notice.

Returns are subject to a restock fee.

Special Orders are non-returnable.

PVC VALVES

Item	Size	Part No.	List Price	Item	Size	Part No.	List Price
SOCKET UTILITY BALL VALVE 	1/2"	28-262200500					
	3/4"	28-262200700					
	1"	28-262201000					
	1-1/4"	28-262201200					
	1-1/2"	28-262201500					
	2"	28-262202000					
	3"	28-262203000					
	4"	28-262204000					
THREADED UTILITY BALL VALVE	1/2"	28-262100500					
	3/4"	28-262100700					
	1"	28-262101000					
	1-1/4"	28-262101200					
	1-1/2"	28-262101500					
	2"	28-262102000					

TITAN INDUSTRIES, INC.
a world of products for the world of water

*Prices are subject to change without notice.
Returns are subject to a restock fee.
Special Orders are non-returnable.*

FUSION FITTINGS

Item	Size	Part No.	List Price	Item	Size	Part No.	List Price
SDR11 BUTT FLANGE ADAPTER	1"	15-11FABF001		SDR11 BUTT TEE	1"	15-11BTE1000	
	1-1/4"	15-11FABF012			1-1/4"	15-11BTE1250	
	1-1/2"	15-11FABF015			1-1/2"	15-11BTE1500	
	2"	15-11FABF020			2"	15-11BTE2000	
	3"	15-11FABF040			3"	15-11BTE3000	
	4"	15-11FABF040			4"	15-11BTE4000	
	6"	15-11FABF060		6"	15-11BTE6000		
MALE IRON CARBON STEEL X SDR11 POLY BUTT ADAPTER	1"	15-11MI101P0		SDR11 BUTT CROSS	1"	15-11CRS1000	
	1-1/4"	15-11MI1212P			1-1/4"	15-11CRS1250	
	1-1/2"	15-11MI1515P			1-1/2"	15-11CRS1500	
	2"	15-11MI202P0			2"	15-11CRS2000	
	3"	15-11MI303P0			3"	15-11CRS3000	
	4"	15-11MI404P0			4"	15-11CRS4000	
	6"	15-11MI606P0		6"	15-11CRS6000		
SDR11 BUTT WYE	2"	15-11WYE2000		SDR11 BUTT REDUCING COUPLER	2" X 1"	15-11RC02010	
	3"	15-11WYE3000			2" X 1-1/4"	15-11RC20125	
	4"	15-11WYE4000			3" X 2"	15-11RC30200	
	6"	15-11WYE6000			4" X 2"	15-11RC40200	
SDR11 BUTT COUPLER	1"	15-11BC10000		4" X 3"	15-11RC04030		
	1-1/4"	15-11BC12500		6" X 4"	15-11RC60400		
	1-1/2"	15-11BC15000		12" X 8"	15-11RC12080		
	2"	15-11BC20000					
	3"	15-11BC30000					
	4"	15-11BC40000					
	6"	15-11BC60000					
SDR11 BUTT FUSION 45° ELBOW	1"	15-11BE45100		SDR11 BUTT REDUCING TEE	2" X 2" X 1"	15-11BTER021	
	1-1/4"	15-11BE45125					
	1-1/2"	15-11BE45150		SDR11 SOCKET CAP	3/4"	15-11SCAP007	
	2"	15-11BE45200					
	3"	15-11BE45300		SDR11 SOCKET COUPLER	3/4"	15-11SCOP007	
	4"	15-11BE45400					
	6"	15-11BE45600		SDR11 SOCKET FUSION 90° ELL	1"	15-11SE90100	
SDR11 BUTT 90° ELBOW	1"	15-11BE90100					
	1-1/4"	15-11BE90125		SDR11 SOCKET TEE	3/4"	15-11ST00700	
	1-1/2"	15-11BE90150					
	2"	15-11BE90200		SDR11 SOCKET CAP	1-1/4" X 3/4"	15-11ST01207	
	3"	15-11BE90300					
	4"	15-11BE90400		SDR11 SOCKET CAP	1/4" X 1-1/4" X	15-11ST01207	
	6"	15-11BE90600					
SDR11 BUTT END CAP	1"	15-11BTCP010		304SS MALE X SDR11 POLY BUTT ADAPTER	1-1/2"X1-1/2"	15-11MS1515P	
	1-1/4"	15-11BTCP012					
	1-1/2"	15-11BTCP015					
	2"	15-11BTCP020					
	3"	15-11BTCP030					
	4"	15-11BTCP040					
	6"	15-11BTCP060					
	8"	15-11BTCP080					
	10"	15-11BTCP100					
	12"	15-11BTCP120					

TITAN INDUSTRIES, INC.
a world of products for the world of water

*Prices are subject to change without notice.
Returns are subject to a restock fee.
Special Orders are non-returnable.*

FUSION FITTINGS

Item	Size	Part No.	List Price	Item	Size	Part No.	List Price
SDR7 BUTT FLANGE ADAPTER	1"	15-07FABF001		SDR7 BUTT TEE	1"	15-07BTE1000	
	1-1/4"	15-07FABF012			1-1/4"	15-07BTE1250	
	1-1/2"	15-07FABF015			1-1/2"	15-07BTE1500	
	2"	15-07FABF020			2"	15-07BTE2000	
	3"	15-07FABF040			3"	15-07BTE3000	
	4"	15-07FABF040			4"	15-07BTE4000	
	6"	15-07FABF060		6"	15-07BTE6000		
MALE IRON CARBON STEEL X SDR7 POLY BUTT ADAPTER	1"	15-07MI101P0		ANODELESS POLY RISER	1"	15-ANODELR10	
	1-1/4"	15-07MI1212P			1-1/4"	15-ANODELR12	
	1-1/2"	15-07MI1515P			2"	15-ANODELR20	
	2"	15-07MI202P0					
	3"	15-07MI303P0					
	4"	15-07MI404P0					
	6"	15-07MI606P0					
SDR7 BUTT WYE	2"	15-07WYE2000					
	3"	15-07WYE3000					
	4"	15-07WYE4000					
	6"	15-07WYE6000					
SDR7 BUTT COUPLER	1"	15-07BC10000					
	1-1/4"	15-07BC12500					
	1-1/2"	15-07BC15000					
	2"	15-07BC20000					
	3"	15-07BC30000					
	4"	15-07BC40000					
	6"	15-07BC60000					
SDR7 BUTT FUSION 45° ELBOW	1"	15-07BE45100					
	1-1/4"	15-07BE45125					
	1-1/2"	15-07BE45150					
	2"	15-07BE45200					
	3"	15-07BE45300					
	4"	15-07BE45400					
	6"	15-07BE45600					
SDR7 BUTT 90° ELBOW	1"	15-07BE90100					
	1-1/4"	15-07BE90125					
	1-1/2"	15-07BE90150					
	2"	15-07BE90200					
	3"	15-07BE90300					
	4"	15-07BE90400					
	6"	15-07BE90600					
SDR7 BUTT END CAP	1"	15-07BTCP010					
	1-1/4"	15-07BTCP012					
	1-1/2"	15-07BTCP015					
	2"	15-07BTCP020					
	3"	15-07BTCP030					
	4"	15-07BTCP040					
	6"	15-07BTCP060					
	8"	15-07BTCP080					
	10"	15-07BTCP100					
	12"	15-07BTCP120					

TITAN INDUSTRIES, INC.
a world of products for the world of water

*Prices are subject to change without notice.
Returns are subject to a restock fee.
Special Orders are non-returnable.*

DUCTILE FITTINGS & ACCESSORIES

Item	Size	Part No.	List Price	Item	Size	Part No.	List Price
MJ GATE VALVE	4"	49-MJGATBA04		DUCTILE	4"	50-DI22MJ040	
	6"	49-MJGATVA06		MJ	6"	50-DI22MJ060	
	8"	49-MJGATBA08		22-1/2°	8"	50-DI22MJ080	
	10"	49-MJGATVA10		ELBOW	10"	50-DI22MJ100	
				W/ACC KIT	12"	50-DI22MJ120	
DUCTILE FLANGED GATE VALVE	2-1/2"	50-GVLV025DI		DUCTILE	6"	50-DICPLR060	
	4"	50-GVLV040DI		MJ	8"	50-DICPLR080	
	6"	50-GVLV060DI		COUPLER	10"	50-DICPLR100	
	8"	50-GVLV080DI		LONG	12"	50-DICPLR120	
COMP FLANGE GATE VALVE	4"	50-GVLVCF040		DUCTILE	6"	50-DICROSS06	
	6"	50-GVLVCF060		MJ	8"	50-DICROSS08	
	8"	50-GVLVCF080		CROSS			
				W/ACC KIT			
GLAND STEM FOR 100 F GATE VALVE	8"	49-PRT100F08		DUCTILE	6" X 4"	50-DIRED6040	
	10"	49-PRT100F10		REDUCER	8" X 4"	50-DIRED8040	
				W/ACC KIT			
CAST IRON VALVE BOX	3'	49-56D106000		DUCTILE	3"	49-MJACS1003	
	5'	49-56D121000		MJ	4"	49-MJACS1004	
C.I. VALVE BOX EXTENSION		49-664S00000		ACCESSORY	6"	49-MJACS1006	
				SET	8"	49-MJACS1008	
VALVE BOX W/RISER PIPE & GRAVEL SHIELD	6"	49-145660000		MJ	3"	49-MJACST003	
				TRANSITION	4"	49-MJACST004	
				ACCESSORY	6"	49-MJACST006	
				KIT	8"	49-MJACST008	
					10"	49-MJACST006	
					12"	49-MJACST008	
VALVE WRENCH	6"	49-56C192000		BOLT	2"	49-GSNAP0200	
				PACK	3"	49-GSNAP0300	
DUCTILE MJ TEE	4"	49-MJTEE0400			4"	49-GSNAP0400	
	6"	49-MJTEE0600			5"	49-GSNAP0500	
W/ACC	8"	49-MJTEE0800			6"	49-GSNAP0600	
KIT	10"	49-MJTEE1000			8"	49-GSNAP0800	
	12"	49-MJTEE1200			10"	49-GSNAP1000	
					12"	49-GSNAP1200	
DUCTILE FLANGED TEE	4"	50-DITEE0400		FIRE	5-1/4" BONNET	50-FIRE525BN	
	4" X 2" MJ THRD	50-DITEE0402		HYDRANT	5' 6" 4" 3W	50-FIRE5643W	
	8"	50-DITEE0800			5' 6" 6" 3W	50-FIRE5663W	
	8" X 4"	50-DITEE0804		C-900	4"	50-040DIPC90	
	8" X 6"	50-DITEE0806		IRON PIPE	6"	50-060DIPC90	
DUCTILE MJ 90° ELBOW	4"	50-DI90MJ040			12"	50-120DIPC90	
	6"	50-DI90MJ060			24"	50-240C90000	
	8"	50-DI90MJ080					
	10"	50-DI90MJ100					
	12"	50-DI90MJ120					
DUCTILE MJ 45° ELBOW	4"	50-DI45MJ040					
	6"	50-DI45MJ060					
	8"	50-DI45MJ080					
	10"	50-DI45MJ100					
	12"	50-DI45MJ120					

CALL FOR QTY DISCOUNT

Prices are subject to change without notice.

Returns are subject to a restock fee.

Special Orders are non-returnable.

TITAN INDUSTRIES, INC.
a world of products for the world of water

DUCTILE FITTINGS & ACCESSORIES

Item	Size	Part No.	List Price	Item	Size	Part No.	List Price
WELD TEE	6"	49-WDTEE6000		DETECTABLE GREEN TAPE	3" X 1000'	49-03GDT0000	
	8"	49-WDTEE6000		DETECTABLE BLUE TAPE	6" X 1000'	49-06GDT0000	
90° WELD ELBOW	6"	50-WE90MJ060		DETECTABLE BLUE TAPE	3" X 1000'	49-056K02200	
	8"	50-WE90MJ060					
45° WELD ELBOW	6"	49-WE45MJ060					
	8"	49-WE45MJ060					
WELD ON COMPRESSION	6" X 4"	49-WCMPR6040					
WELD FLANGE	2"	49-FLNGWD020					
	3"	49-FLNGWS030					
	4"	49-FLNGWD040					
	6"	49-FLNGWD060					
	2" STEEL	49-FLNGWDS02					
	8" STEEL	49-FLNGWD080					
	10" STEEL	49-FLNGWD100					
THREADED FLANGE	2"	49-FLNGTH020					
	3"	49-FLNGTH030					
	4"	49-FLNGTH040					
	6"	49-FLNGTH060					
	8"	49-FLNGTH080					
	10"	49-FLNGTH100					
FULL FACE FLANGE	8"	49-FLNGFF080					
	10"	49-FLNGFF100					
IPS FLANGE	8-5/8"	49-FLNGIPS08					
PLASTIC FLANGE	8"W/PIP INSERT	49-FLNGPL080					
	10"W/PIP INSERT	49-FLNGPL100					
FLANGE GASKET	3"	49-FLNGSK030					
	4"	49-FLNGSK040					
	6"	49-FLNGSK060					
	8"	49-FLNGSK080					
	10"	49-FLNGSK100					
CAST IRON GATE VALVE	4" FLANGED	48-115F11000					
	4" RING-TITE	48-100RT1100					
	4" THREADED	48-100S11000					

TITAN INDUSTRIES, INC.
a world of products for the world of water

*Prices are subject to change without notice.
Returns are subject to a restock fee.
Special Orders are non-returnable.*

NOTES

CALL US TODAY!

PO Box 308
East Hwy 30
Paxton, Nebraska 69155
800-658-4086
308-239-4281
308-239-4474 (fax)

11555 S. Highway 283
Dodge City, Kansas 67801
800-658-4078
620-225-6201
620-225-1171 (fax)











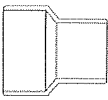
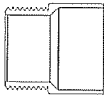
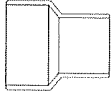

1203 S.E. Grand Blvd.
Oklahoma, City, Oklahoma 73129
800-749-8659
405-677-1290
405-677-1296 (fax)

112 Grant - Aurora Industrial Park
Aurora, Nebraska 68818
800-255-4188
402-694-4188
402-694-4511 (fax)

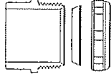
1912 West Harry
Wichita, Kansas 67213
866-323-9111
316-262-9111
316-262-9119 (fax)

TITAN INDUSTRIES, INC.
a world of products for the world of water

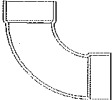

DWV SCHEDULE 40 PVC FITTINGS

Item	Size	Part No.	List Price	Item	Size	Part No.	List Price
SLIP COUPLER 	1-1/2"	24-D10001500		CLEANOUT PLUG W/ RAISED NUT (MIPT) 	1-1/2"	24-D10601500	
	2"	24-D10002000			2"	24-D10602000	
	3"	24-D10003000			3"	24-D10603000	
	4"	24-D10004000			4"	24-D10604000	
	6"	24-D10006000			6"	24-D10606000	
FEMALE ADAPTER (SLIPXFIPT) 	1-1/2"	24-D10101500		FLUSH BUSHING (SP X SLIP) 	2" X 1-1/2"	24-D10725100	
	2"	24-D10102000			3" X 2"	24-D10733800	
	3"	24-D10103000			4" X 2"	24-D10742000	
	4"	24-D10104000			6" X 4"	24-D10753200	
REDUCING SLIP COUPLER 	2" X 1-1/2"	24-D10225100		MALE ADAPTER (SLIPXMIPT) 	2"	24-D10902000	
	3" X 1-1/2"	24-D10233700			3"	24-D10903000	
	3" X 2"	24-D10233800			4"	24-D10904000	
	4" X 2"	24-D10242000			1-1/2" X 1-1/4"	24-D10921200	
	4" X 3"	24-D10242200		SLIP ADAPTER COUPLER 	MALE TRAP ADAPTER W/PLASTIC NUT (SPXSJ) 	1-1/2"	24-D11301500
2"	24-D11302000		2"			24-D11302000	
1-1/2" X 1-1/4"	24-D11321200		1-1/2" X 1-1/4"			24-D11321200	
FEMALE TRAP ADAPTER W/PLASTIC NUT (SPXSJ) 	1-1/2"	24-D10401500		REPAIR SLIP COUPLER 	1-1/2"	24-D13001500	
	2"	24-D10402000			2"	24-D13002000	
	1-1/2" X 1-1/4"	24-D10421200			3"	24-D13003000	
					4"	24-D13004000	
CLEANOUT ADAPTER (SPXFIPT) 	1-1/2"	24-D10501500		TEST CAP INSERT 	1-1/2"	24-D13101500	
	2"	24-D10502000			2"	24-D13102000	
	3"	24-D10503000			3"	24-D13103000	
	4"	24-D10504000			4"	24-D13104000	
	6"	24-D10506000		90° SLIP ELBOW 	1-1/4"	24-D30001200	
1-1/2"	24-D11201500		1-1/2"		24-D30001500		
2"	24-D11202000		2"		24-D30002000		
3"	24-D11203000		3"		24-D30003000		
CLEAN-OUT ADAPTER W/PLUG 	4"	24-D11204000		4"	24-D30004000		
	6"	24-D11206000		6"	24-D30006000		

TITAN INDUSTRIES, INC.
a world of products for the world of water

Prices are subject to change without notice.
Returns are subject to a restock fee.
Special Orders are non-returnable.

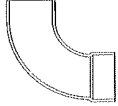
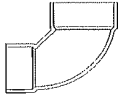
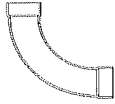
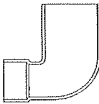
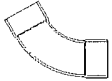
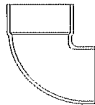
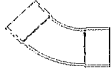
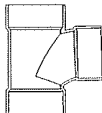

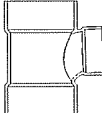
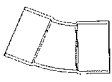
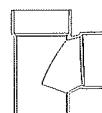
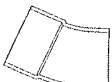
DWV SCHEDULE 40 PVC FITTINGS

Item	Size	Part No.	List Price	Item	Size	Part No.	List Price
90° STREET ELBOW (SLIP X SP) 	1-1/4"	24-D30201200		REDUCING CLOSET BEND (SLIPXSLIP) 	4"X3"	24-D32942200	
	1-1/2"	24-D30201500					
	2"	24-D30202000					
	3"	24-D30203000					
	4"	24-D30204000					
6"	24-D30206000						
LONG SWEEP 90° SLIP ELBOW 	1-1/2"	24-D30401500		REDUCING CLOSET BEND (SLIP X SP) 	3" X 4"	24-D33034100	
	2"	24-D30402000					
	3"	24-D30403000					
	4"	24-D30404000					
	6"	24-D30406000					
60° SLIP ELBOW 	1-1/2"	24-D31901500		90° VENT ST. ELBOW (SLIP X SP) 	1-1/2"	24-D33301500	
	2"	24-D31902000			2"	24-D33302000	
	3"	24-D31903000			3"	24-D33303000	
	4"	24-D31904000			4"	24-D33304000	
45° SLIP ELBOW 	1-1/4"	24-D32101200		SANITARY SLIP TEE 	1-1/4"	24-D40001200	
	1-1/2"	24-D32101500			1-1/2"	24-D40001500	
	2"	24-D32102000			2"	24-D40002000	
	3"	24-D32103000			3"	24-D40003000	
	4"	24-D32104000			4"	24-D40004000	
6"	24-D32106000	6"	24-D40006000				
45° STREET ELBOW (SLIPXSP) 	1-1/4"	24-D32301200		SANITARY REDUCING SLIP TEE 	2"X1-1/2"X1-1/2"	24-D40124100	
	1-1/2"	24-D32301500			2"X1-1/2"X2"	24-D40124200	
	2"	24-D32302000			2"X2"X1-1/2"	24-D40125100	
	3"	24-D32303000			3"X3"X1-1/2"	24-D40133700	
	4"	24-D32304000			3"X3"X2"	24-D40133800	
6"	24-D32306000	4"X4"X2"	24-D40142000				
22-1/2° SLIP ELBOW 	1-1/2"	24-D32401500		SANITARY ST. TEE (SLIP X SP) 	4"X4"X3"	24-D40142200	
	2"	24-D32402000			6"X6"X4"	24-D40153200	
	3"	24-D32403000			1-1/2"	24-D40301500	
	4"	24-D32404000			2"	24-D40302000	
	6"	24-D32406000			3"	24-D40303000	
22-1/2° ST. ELBOW (SPXSLIP) 	1-1/2"	24-D32601500			4"	24-D40304000	
	2"	24-D32602000					
	3"	24-D32603000					
	4"	24-D32604000					

TITAN INDUSTRIES, INC.
a world of products for the world of water

*Prices are subject to change without notice.
Returns are subject to a restock fee.
Special Orders are non-returnable.*

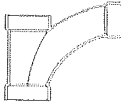
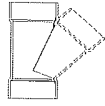
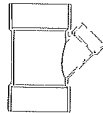
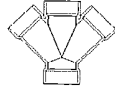
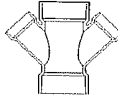



DWV SCHEDULE 40 PVC FITTINGS

Item	Size	Part No.	List Price	Item	Size	Part No.	List Price	
SANITARY TEE, STREET REDUCING (SLIP X SP)	2"X1-1/2"X1-1/2"	24-D40424100			2"X1-1/2"X1-1/2"	24-D50224100		
	2"X1-1/2"X2"	24-D40424200			2"X2"X1-1/2"	24-D50225100		
DOUBLE SANITARY SLIP TEE	1-1/2"	24-D42801500				3"X3"X1-1/2"		24-D50233700
	2"	24-D42802000				3"X3"X2"		24-D50233800
	3"	24-D42803000				4"X4"X2"		24-D50242000
	4"	24-D42804000				4"X4"X3"		24-D50242200
DOUBLE SANITARY RED TEE	3"X3"X	24-D42933700				1-1/2"X1-1/2"		24-D60125100
	1-1/2"X1-1/2"	24-D42933800		3"X3"X1-1/2"		24-D60133700		
	3"X3"X2"X2"	24-D42294220		3"X3"X2"		24-D60133800		
	4"X4"X3"X3"			4"X4"X2"		24-D60142000		
VENT SLIP TEE	1-1/2"	24-D44101500			4"X4"X3"	24-D60142200		
	2"	24-D44102000			6"X6"X4"	24-D60153200		
	4"	24-D44104000			DOUBLE REDUCING SLIP WYE	2"X2"X	24-D61225200	
	6"	24-D44106000				1-1/2"X1-1/2"	24-D61233700	
CLEANOUT TEE W/ C/O PLUG	1-1/2"	24-D44301500			3"X3"X	24-D61233800		
	2"	24-D44302000			1-1/2"X1-1/2"	24-D61242200		
	4"	24-D44304000			3"X3"X2"X2"	24-D61253200		
	6"	24-D44306000			4"X4"X3"X3"			
2-WAY SLIP CLEANOUT	3"	24-D44803000			6"X6"X4"X4"			
	4"	24-D44804000			1-1/2"	24-D70001500		
45° COMBO SLIP WYE W/ LONG TURN	1-1/2"	24-D50101500			2"	24-D70002000		
	2"	24-D50102000			3"	24-D70003000		
	3"	24-D50103000			4"	24-D70004000		
	4"	24-D50104000			SLIP P-TRAP LOW PROFILE	1-1/2"	24-D70601500	
		2"	24-D70602100					

TITAN INDUSTRIES, INC.
a world of products for the world of water

Prices are subject to change without notice.
 Returns are subject to a restock fee.
 Special Orders are non-returnable.

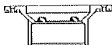
DWV SCHEDULE 40 PVC FITTINGS

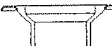
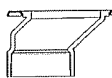
Item	Size	Part No.	List Price	Item	Size	Part No.	List Price	
SLIP P-TRAP UNION W/ PLASTIC NUT 	1-1/2"	24-D70801600		COMBO CLEANOUT TEST PLUG	1-1/2"	24-AGS152000		
	2"	24-D70802100			2"	24-AGS202000		
SLIP CLOSET FLANGE 	4"X4"	24-D80004000			TECHNO-CAP	3"	24-AGS302000	
	4"X3"	24-D80042200				4"	24-AGS402000	
CLOSET FLANGE W/KO SPIGOT 	4" X 3	24-D81042200		1-1/2"		24-AGTC10000		
				2"		24-AGTC20000		
SLIP CLOSET FLANGE ADJUSTABLE W/METAL RING 	4"X4"	24-D81104000		3"	24-AGTC30000			
	4"X3"	24-D81142200		4"	24-AGTC40000			
SPIG CLOSET FLANGE ADJUSTABLE W/METAL RING 	4"X4"	24-D81204000						
	4"X3"	24-D81242200						
OFFSET CLOSET FLANGE ADJUSTABLE W/METAL RING 	4"X3"OFFSET	24-D82342200						

TITAN INDUSTRIES, INC.
a world of products for the world of water

Prices are subject to change without notice.
Returns are subject to a restock fee.
Special Orders are non-returnable.

DWV COUPLERS & CAPS

Item	Size	Part No.	List Price	Item	Size	Part No.	List Price	
SCH40 SLIP TEE	10"	27-370110000		SCH40 SLIP COUPLER	10"	27-372910000		
	12"	27-370112000			12"	27-372912000		
	16"	27-370116000			14"	27-372914000		
	16" X 10"	27-370176000			16"	27-372916000		
			18"		27-372918000			
SCH40 SLIP SADDLE	6" X 4"	27-370353210		SCH40 REDUCING SLIP COUPLER	8" X 4"	27-372958200		
	8" X 4"	27-370358210			8" X 6"	27-372958500		
	8" X 6"	27-370358510			10" X 4"	27-372962400		
	10" X 6"	27-370362610			10" X 6"	27-372962600		
12" X 6"	27-370366610	10" X 8"	27-372962800					
			12" X 8"		27-372966800			
SCH40 90° SLIP ELBOW	10"	27-370610000			12" X 8"	27-372966800		
	12"	27-370612000			12" X 10"	27-372967000		
	16"	27-370616000			14" X 8"	27-372969900		
	18"	27-370618000			14" X 12"	27-372970200		
SCH40 22-1/2° SLIP ELBOW	12"	27-371612000			SCH40 SLIP CAP	10"		27-374710000
	16"	27-371616000		12"		27-374712000		
				14"		27-374714000		
				16"		27-374716000		
				18"		27-374718010		
			24"	27-374724010				
SCH40 45° SLIP ELBOW	8"	27-371708000		CLEANOUT PLUG	8" (MIPT) W/RAISED NUT	27-374808060		
	10"	27-371710000						
	12"	27-371712000						
SCH40 45° SLIP ELBOW	8"	27-371708000		SCH40 SLIP WYE	10"	27-377510000		
	10"	27-371710000						
	12"	27-371712000						
SCH40 MALE ADAPTER	10"	27-371910016		REDUCING SLIP WYE	8"X8"X4"	27-377558200		
SCH40 REPAIR COUPLER	6"	27-372806000		CLEAN-OUT ADAPTER	SCH 40 (SP X FIPT)			
	8"	27-372808000			8"	27-377808000		
	W/O CENTER STOP				12"	27-377812000		
		SCH 80 (SLIP X FIPT)						
		8"	27-391908015					
		10"	27-391910015					

TITAN INDUSTRIES, INC.
a world of products for the world of water

*Prices are subject to change without notice.
Returns are subject to a restock fee.
Special Orders are non-returnable.*

DWV COUPLERS & CAPS

Item	Size	Part No.	List Price	Item	Size	Part No.	List Price
FIPT THREAD PLUG	12"	27-378012000					
SCH80 90° SLIP ELBOW	12"	27-390612000					
SCH80 45° SLIP ELBOW	12"	27-391712000					
	16"	27-391716000					
SCH80 SLIP COUPLER	10"	27-392910000					
	12"	27-392912000					
	14"	27-392914000					
	16"	27-392916000					
SCH80 REDUCING SLIP COUPLER	10" X 6"	27-392962600					
	12" X 4"	27-393266410					

TITAN INDUSTRIES, INC.
a world of products for the world of water

Prices are subject to change without notice.
Returns are subject to a restock fee.
Special Orders are non-returnable.

SEWER & DRAIN FITTINGS

Item	Size	Part No.	List Price	Item	Size	Part No.	List Price
SDR35 STRAIGHT TEE	3"	31-P10200000		SDR35 1/4 BEND	3"	31-P20200000	
	4"	31-P10400000			4"	31-P20400000	
	6"	31-P10600000			6"	31-P20600000	
	8"	31-P10800000			8"	31-P20800000	
	6"X4"	31-P11600000		SDR35 1/4 BEND SPIGOT	6"	31-P22600000	
	8"X4"	31-P10840000			8"	31-P22800000	
8"X6"	31-P10860000	SDR35 1/4 BEND LONG TURN	3"	31-P25500000			
SDR35 THREADED PLUG	4"		31-P11540000	4"	31-P25600000		
	6"		31-P11560000	6"	31-P25700000		
	8"	31-P11580000	8"	31-P25800000			
SDR35 DWV BUSHING	3"X1-1/2"	31-P12020000		SDR35 ADAPTER SLEEVE	4"X4"	31-P12080000	
	3"X2"	31-P12030000			6"X6"	31-P12090000	
	4"X1-1/2"	31-P12040000		SDR35 MALE ADAPTER	3"	31-P13030000	
	4"X2"	31-P12050000			4"	31-P13040000	
	4"X3"	31-P12110000			SDR35 FEMALE ADAPTER	3"	31-P14030000
	4"X4"	31-P12130000				4"	31-P14040000
	6"X4"	31-P12140000				6"	31-P14060000
6"X6"	31-P12150000	8"	31-P14080000				
SDR35 REDUCING BUSHING	6"X4"	31-P12160000		SDR35 FITTING CLEANOUT	3"	31-P15030000	
	8"X6"	31-P12180000			4"	31-P15040000	
SDR35 SLIP CAP	3"	31-P16030000			6"	31-P15060000	
	4"	31-P16040000			8"	31-P15080000	
	6"	31-P16060000		SDR35 1/16 BEND	3"	31-P17030000	
	8"	31-P16080000			4"	31-P17040000	
	10"	31-P16100000			6"	31-P17060000	
SDR35 1/16 BEND	4"	31-P17080000		SDR35 1/16 BEND SPIGOT	4"	31-P17140000	
	6"	31-P17060000			6"	31-P17160000	
	8"	31-P17080000			8"	31-P17180000	
	8"	31-P17080000					

TITAN INDUSTRIES, INC.
a world of products for the world of water

Prices are subject to change without notice.

Returns are subject to a restock fee.

Special Orders are non-returnable.

SEWER & DRAIN FITTINGS

Item	Size	Part No.	List Price	Item	Size	Part No.	List Price
SDR35 SANITARY TEE	3"	31-P15500000		SDR35 SADDLE WYE	4" ON 6"	31-P23064000	
	4"	31-P15600000			4" ON 8"	31-P23084000	
	6"	31-P15700000			6" ON 8"	31-P23086000	
	6"X4"	31-P15740000					
	8"	31-P15800000					
	8"X4"	31-P15840000					
	8"X6"	31-P15860000					
SDR35 TEE CROSS				SDR35 1/4 BEND			
	4"	31-P17900000			3"	31-P27200000	
SDR35 CLOSET FLANGE				SDR35 LONG TURN SPIGOT			
	3"	31-P18030000			4"	31-P27400000	
	4"	31-P18040000			6"	31-P27700000	
					8"	31-P27800000	
SDR35 DOWNSPOUT ADAPTER				SDR35 1/8 BEND SPIGOT			
	2"X3"X3"	31-P19030000			3"	31-P40200000	
	2"X3"X4"	31-P19040000			4"	31-P40400000	
	3"X4"X3"	31-P19050000			6"	31-P40600000	
	3"X4"X4"	31-P19060000			8"	31-P40800000	
SDR35 DOWNSPOUT ADP FLUSH				SDR35 SADDLE TEE W/LOC RING			
	2"X3"X3"	31-P19230000			4" ON 6"	31-P41064000	
	2"X3"X4"	31-P19240000			4" ON 8"	31-P41084000	
	3"X4"X4"	31-P19260000			6" ON 8"	31-P41086000	
	4"X6"X6"	31-P19280000					
SDR35 DSP ADP FLUSH X CR SP				SDR35 SADDLE WYE W/LOC RING			
	2"X3"X4"	31-P19440000			4" ON 6"	31-P43064000	
	3"X4"X4"	31-P19460000			4" ON 8"	31-P43084000	
	4"X6"X6"	31-P19480000			6" ON 8"	31-P43086000	
SDR35 SADDLE TEE				SDR35 COUPLER (HXH)			
	4" ON 6"	31-P21064000			3"	31-P60200000	
	4" ON 8"	31-P21084000			4"	31-P60400000	
	6" ON 8"	31-P21086000			6"	31-P60600000	
					8"	31-P60800000	
					10"	31-P60100000	
					12"	31-P60120000	
					15"	31-P60150000	

TITAN INDUSTRIES, INC.
a world of products for the world of water

*Prices are subject to change without notice.
Returns are subject to a restock fee.
Special Orders are non-returnable.*

SEWER & DRAIN FITTINGS

Item	Size	Part No.	List Price	Item	Size	Part No.	List Price
SDR35 REDUCING COUPLER	3"X2"	31-P65300000		SDR35 CLAY SPIGOT ADPT	4"	31-P85400000	
	4"X2"	31-P65600000					
	4"X3"	31-P65400000					
	6"X4"	31-P66100000					
	8"X4"	31-P60840000					
	8"X6"	31-P60860000					
	10"X4"	31-P60140000					
	10"X8"	31-P60106000					
SDR35 45° WYE	10"	31-P30100000		SDR35 FIBER HUB ADPT	4"	31-P87500000	
	10"X4"	31-P30104000					
	3"	31-P30200000					
	4"	31-P30400000		PRINSCO EDTERNAL END CAP	8" 10"	31-PEC080000 31-PEC100000	
	6"	31-P30600000					
	8"	31-P30800000					
	8"X4"	31-P30840000					
	8"X6"	31-P30860000					
6"X4"	31-P31600000						
6"X4"(DOUBLE)	31-P36640000						
SDR35 1/8 BEND	3"	31-P50200000		PRINSCO STEP-DOWN TEE	8"X8"	31-PTE080000	
	4"	31-P50400000					
	6"	31-P50600000					
	8"	31-P50800000					
	10"	31-P50100000					
SDR35 X DWV COUPLER	3"X2"	31-P65200000		PRINSCO END CAP W/ 4" OUTLET	8"X4"	31-PCP080040	
	4"X3"	31-P65500000					
	4"X4"	31-P65700000					
SDR35 CLAY HUB ADPT	4"	31-P75400000		PRINSCO END CAP W/4" SV QUIK-TITE	10'	31-PCP100040	
SDR35 CI HUB ADPT	4"	31-P80400000					

TITAN INDUSTRIES, INC.
a world of products for the world of water

Prices are subject to change without notice.

Returns are subject to a restock fee.

Special Orders are non-returnable.

GASKETED SEWER & DRAIN FITTINGS

Item	Size	Part No.	List Price	Item	Size	Part No.	List Price
SDR35 STRAIGHT TEE	4"	32-G10400000		SDR35 1/4 BEND SPIGOT	4"	32-G22400000	
	6"	32-G10600000			6"	32-G22600000	
	6"X4	32-G10640000			8"	32-G22800000	
	8"	32-G10800000					
	8"X4"	32-G10840000					
	8"X6"	32-G10860000					
	12"	32-G10120000					
SDR35 SPIGOT PLUG	4"	32-G11640000		SDR35 1/4 BEND LONG TURN	4"	32-G25600000	
	6"	32-G11660000			6"	32-G25700000	
	8"	32-G11680000			8"	32-G25800000	
			10"		32-G25100000		
			15"		32-G25150000		
SDR35 TEMPORARY PLUG	4"	32-G11840000		SDR35 1/4 BEND LONG TURN SPIGOT	4"	32-G27400000	
	6"	32-G11860000			6"	32-G27700000	
					8"	32-G27800000	
SDR35 PERMANENT SPIGOT PLUG	10"	32-G11910000		SDR35 1/8 BEND SPIGOT	4"	32-G40400000	
	12"	32-G11912000			6"	32-G40600000	
					8"	32-G40800000	
SDR35 1/16 BEND	4"	32-G17040000		SDR35 1/8 BEND	4"	32-G50400000	
	6"	32-G17060000			6"	32-G50600000	
	8"	32-G17080000			8"	32-G50800000	
			10"		32-G51000000		
SDR35 1/16 BEND SPIGOT	4"	32-G17140000		SDR35 STRAIGHT TEE SPIGOT	4"	32-G12400000	
	6"	32-G17160000			6"	32-G12600000	
	8"	32-G17180000			6"X4"	32-G12640000	
			8"		32-G12800000		
			8"X4"		32-G12840000		
			8"X6"	32-G12860000			
SDR35 1/4 BEND	4"	32-G20400000		SDR35 SANITARY TEE	4"	32-G15600000	
	6"	32-G20600000			6"	32-G15700000	
	8"	32-G20800000			6"X4"	32-G15740000	
			8"		32-G15800000		
			8"X4"		32-G15840000		
			8"X6"		32-G15860000		

Prices are subject to change without notice.

Returns are subject to a restock fee.

Special Orders are non-returnable.

TITAN INDUSTRIES, INC.
a world of products for the world of water

GASKETED SEWER & DRAIN FITTINGS

Item	Size	Part No.	List Price	Item	Size	Part No.	List Price
SDR35 CAP	4"	32-G16040000		SDR35 REPAIR COUPLER	4"	32-G62400000	
	6"	32-G16060000			6"	32-G62600000	
	8"	32-G16080000			8"	32-G62800000	
SDR35 1/8 BEND COMBO WYE	6"	32-G16560000		SDR35 DWV COUPLER	4"X4"	32-G65700000	
	6"X4"	32-G16564000			6"X4"	32-G65800000	
					6"X6"	32-G65900000	
SDR35 SANITARY TEE SPIGOT	4"	32-G17400000		SDR35 HUB ADAPTER WELDXGAS	4"X4"	32-G64400000	
	6"	32-G17700000			6"X6"	32-G64600000	
	6"X4"	32-G17740000			6"X4"	32-G64640000	
	8"	32-G17800000			8"X8"	32-G64800000	
	8"X4"	32-G17840000					
	8"X6"	32-G17860000					
SDR35 45° WYE	4"	32-G30400000		SDR35 HUB ADAPTER WELD SPIG X GASKET	4"X4"	32-G90400000	
	6"	32-G30600000			6"X4"	32-G90600000	
	6"X4"	32-G30640000			6"X6"	32-G90800000	
	8"	32-G30800000					
	8"X4"	32-G30840000					
	8"X6"	32-G30860000					
	10"X4"	32-G30104000					
SDR35 45° WYE SPIGOT	4"	32-G32400000					
	6"	32-G32600000					
	6"X4"	32-G32640000					
	8"	32-G32800000					
	8"X4"	32-G32840000					
	8"X6"	32-G32860000					
SDR35 COUPLER	4"	32-G60400000					
	6"	32-G60600000					
	8"	32-G60800000					
	10"	32-G61000000					
SDR35 INCREASER	6"X4"	32-G60640000					
	8"X4"	32-G60840000					
	8"X6"	32-G60860000					

TITAN INDUSTRIES, INC.
a world of products for the world of water

*Prices are subject to change without notice.
Returns are subject to a restock fee.
Special Orders are non-returnable.*

SEPTIC TANKS, LEACHFIELDS, CISTERNS & PUMPS

Item	Size	Part No.	List Price	Item	Size	Part No.	List Price
SINGLE COMPARTMENT SEPTIC TANK	300 GAL	40-STANK0300		BELOW GROUND CISTERNS	325 GAL	40-CISTR0325	
	500 GAL	40-STANK0500			525 GAL	40-CISTR0525	
	750 GAL	40-STANK0750			1200 GAL	40-CISTR1200	
	1000 GAL	40-STANK1000			1700 GAL	40-CISTR1700	
	1050 GAL	40-STANK1050					
	1250 GAL	40-STANK1250					
	1500 GAL	40-STANK1500		ABOVE GROUND STORAGE TANKS	PLEASE CALL FOR PRICES, SIZES AND AVAILABILITY		
DOUBLE COMPARTMENT SEPTIC TANK	750 GAL	40-DTANK0750		SEWAGE BASINS & ACCESSORIES			
	1050 GAL	40-DTANK1050		18" X 22"		03-ZHSB18220	
	1250 GAL	40-DTANK1250		W/SLOTTED COVER			
	1500 GAL	40-DTANK1500		18" X 30"		31-ZSF30HSGT	
SEPTIC TANK LID		40-SEPTICLID		W/SPLIT COVER			
TANK GASKET		40-TANKGASKT		2" X 2"		31-ZSF114000	
MANHOLE EXTENTIONS	12" H X 24" D	40-MANEXTENS		SPLIT COVER ONLY			
	12" H X 24" D	40-MANEXTE12		1-1/4"-1-1/2"		03-ZSUMPCHCK	
HANCOR DISTRIBUTION BOX		40-SEPDISBOX		CHECK VALVE			
				1-1/2" CHECK VALVE		03-Z57028002	
INFILTRATOR CHAMBERS	WIDE	40-INFILTRLG		1-1/2" MIPT CHECK W/RUBBER BOOT		03-Z66005BLA	
	NARROW	40-INFILTRSM		2" COMP CHECK VALVE		03-Z15002000	
INFILTRATOR OPEN ENDS	WIDE	40-INFENDSLG		2" CHECK W/PIPE HOSE CONNECTION		31-Z2GP00000	
	NARROW	40-INFENDSSM		1/2-1HP 115/230V RFSN-9 REMOTE FLOAT SWITCH		03-599117000	
INFILTRATOR CLOSED ENDS	WIDE	40-INCLENDLG		115 VOLT LITTLE GIANT PUMPS			
	NARROW	40-INCLENDSM		1/6HP 5-MSP WATER WIZARD		03-505000000	
120 VOLT SEWAGE / SUMP PUMPS				1/4HP 5.5-ASP EFFLUENT PUMP		03-505700000	
	4/10 HP	03-BSEL40000		1/3HP WRS-6 DRAINOSAUR		03-506055000	
	RESIDENTAL SEWAGE			1/3HP WRSC-6 DRAINOSAUR		03-506065000	
	1/3 HP PEDISTAL SUMP PUMP	03-BTU330000		1/3HP 6-CIA BIG JOHN		03-506158000	
	4/10 HP CAST IRON SEWAGE	03-CSE400000		1/3HP 6-CIA-RFS BIG JOHN		03-506171000	
	6/10 HP CAST IRON SEWAGE	03-CSE600000		1/3HP 6E-CIA-SFS ELIMINATOR		03-506700000	
				4/10HP 9S-CIA-RFS DOMINATOR		03-509500000	
				1/2HP 10S-CIA-RFS DOMINATOR		03-511500000	









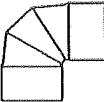

Prices are subject to change without notice.

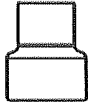
Returns are subject to a restock fee.

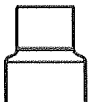
Special Orders are non-returnable.

TITAN INDUSTRIES, INC.
a world of products for the world of water

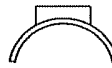

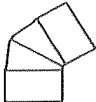
LOWHEAD PIP FITTINGS

Item	Size	Part No.	List Price	Item	Size	Part No.	List Price
COUPLER 	6"	34-28010002		90° ELBOW 	6"	34-280100812	
	8"	34-280100003			8"	34-280100813	
	10"	34-280100004			10"	34-280100814	
	12"	34-280100005			12"	34-280100815	
	15"	34-280100006			15"	34-280100816	
	18"	34-280100007			18"	34-280100817	
20"	34-280100008	20"	34-280100818				
11-1/4° ELBOW 	6"	34-280100114		REDUCER COUPLER 	8" X 6"	34-280100928	
	8"	34-280100115			10" X 8"	34-280100931	
	10"	34-280100116			12" X 10"	34-280100935	
	12"	34-280100117			15" X 12"	34-280100940	
	15"	34-280100118			18" X 15"	34-280100946	
	18"	34-280100119			20" X 18"	34-280100953	
15° ELBOW 	6"	34-280100234		PIP X IPS REDUCER 	6" X 4"	34-280101536	
	8"	34-280100235			8" X 6"	34-280101537	
	10"	34-280100236			10" X 8"	34-280101538	
	12"	34-280100237			12" X 10"	34-280101539	
	15"	34-280100238			15" X 12"	34-280101540	
	18"	34-280100239					
20"	34-280100240						
22-1/2° ELBOW 	6"	34-280100354		IPS X PIP ADAPTER 	6"	34-280101649	
	8"	34-280100355			8"	34-280101650	
	10"	34-280100356			10"	34-280101651	
	12"	34-280100357			12"	34-280101652	
	15"	34-280100358					
	18"	34-280100359					
20"	34-280100360						
30° ELBOW 	6"	34-280100474		SADDLE 	6" X 2"	34-280101789	
	8"	34-280100475			10" X 2"	34-280101791	
	10"	34-280100476			15" X 2"	34-280101792	
	12"	34-280100477			18" X 2"	34-280101794	
	15"	34-280100478			6" X 3"	34-280101797	
	18"	34-280100479			8" X 3"	34-280101798	
20"	34-280100480	10" X 3"	34-280101799				
45° ELBOW 	6"	34-280100592			12" X 3"	34-280101800	
	8"	34-280100593			10" X 2"	34-280101886	
	10"	34-280100594			12" X 6"	34-280101908	
	12"	34-280100595			15" X 6"	34-280101909	
	15"	34-280100596			18" X 6"	34-280101910	
	18"	34-280100597			10" X 8"	34-280101912	
20"	34-280100598	12" X 8"	34-280101913				
60° ELBOW 	6"	34-280100704		15" X 8"	34-280101914		
	8"	34-280100704		18" X 8"	34-280101915		
	10"	34-280100704		12" X 10"	34-280101917		
	12"	34-280100704		15" X 10"	34-280101918		
				18" X 10"	34-280101919		
				15" X 12"	34-280101921		
				18" X 12"	34-280101922		

TITAN INDUSTRIES, INC.
a world of products for the world of water

*Prices are subject to change without notice.
Returns are subject to a restock fee.
Special Orders are non-returnable.*

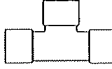





LOWHEAD PIP FITTINGS

Item	Size	Part No.	List Price	Item	Size	Part No.	List Price
TEE 	6" X 2"	34-280102499		SURFACE REDUCER CONT.	12" X 4"	34-280102034	
	6" X 3"	34-280102500			12" X 6"	34-280102035	
	6" X 4"	34-280102501			12" X 8"	34-280102036	
	6" X 6"	34-280102502			15" X 2"	34-280102048	
	8" X 2"	34-280102503			15" X 3"	34-280102050	
	8" X 4"	34-280102505			15" X 4"	34-280102051	
	8" X 6"	34-280102506			15" X 6"	34-280102052	
	8" X 8"	34-280102507			15" X 8"	34-280102053	
	10" X 2"	34-280102508			15" X 10"	34-280102054	
	10" X 4"	34-280102510			18" X 2"	34-280102067	
	10" X 6"	34-280102511			18" X 3"	34-280102069	
	10" X 8"	34-280102512			18" X 4"	34-280102070	
	10" X 10"	34-280102513			18" X 6"	34-280102071	
	12" X 2"	34-280102514			18" X 8"	34-280102072	
	12" X 3"	34-280102515			18" X 10"	34-280102073	
	12" X 6"	34-280102517			18" X 12"	34-280102074	
	12" X 8"	34-280102518					
	12" X 10"	34-280102519					
	12" X 12"	34-280102520					
	15" X 2"	34-280102521					
	15" X 3"	34-280102522					
	15" X 4"	34-280102523					
	15" X 6"	34-280102524					
	15" X 8"	34-280102525					
	15" X 10"	34-280102526					
	15" X 12"	34-280102527					
	15" X 15"	34-280102528					
	6" X 2"	34-280110249					
	8" CROSS	34-280110329					
	8" X 3"	34-280158531					
12" X 4"	34-280166431						
10" X 3"	34-281623311						
CAP 	6"	34-280107540					
	8"	34-280107541					
	10"	34-280107542					
	12"	34-280107543					
	15"	34-280107545					
	18"	34-280107547					
	20"	34-280107549					
SURFACE REDUCER	6" X 2"	34-280102013					
	6" X 3"	34-280102015					
	8" X 2"	34-280102018					
	8" X 3"	34-280102020					
	8" X 4"	34-280102021					
	8" X 6"	34-280102022					
	10" X 2"	34-280102024					
	10" X 3"	34-280102026					
	10" X 4"	34-280102027					
	10" X 6"	34-280102028					
	12" X 2"	34-280102031					
	12" X 3"	34-280102033					

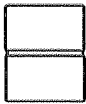
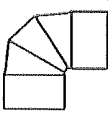
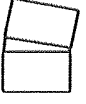
TITAN INDUSTRIES, INC.
a world of products for the world of water

*Prices are subject to change without notice.
Returns are subject to a restock fee.
Special Orders are non-returnable.*

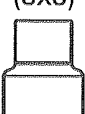

80# PIP SOLVENT WELD FITTINGS

Item	Size	Part No.	List Price	Item	Size	Part No.	List Price
COUPLER (SXS) 	6"	35-290100002		90° ELBOW (SWXSW) 	6"	35-290100812	
	8"	35-290100003			8"	35-290100813	
	10"	35-290100004			10"	35-290100814	
	12"	35-290100005			12"	35-290100815	
	14"	35-290100001			15"	35-290100816	
	15"	35-290100006			18"	35-290100817	
	18"	35-290100007					
	24"	35-290100010					
11-1/4° ELBOW (SWXSW) 	6"	35-290100114		TEE (SXSXS) 	6" X 2"	35-290102499	
	8"	35-290100115			6" X 3"	35-290102500	
	10"	35-290100116			6" X 4"	35-290102501	
	12"	35-290100117			6" X 6"	35-290102502	
	15"	35-290100118			8" X 2"	35-290102503	
	18"	35-290100119			8" X 3"	35-290102504	
					8" X 4"	35-290102505	
15° ELBOW (SWXSW) 	6"	35-290100234			8" X 6"	35-290102506	
	8"	35-290100235			8" X 8"	35-290102507	
	10"	35-290100236			10" X 2"	35-290102508	
	12"	35-290100237			10" X 3"	35-290102509	
	15"	35-290100238			10" X 4"	35-290102510	
	18"	35-290100239			10" X 6"	35-290102511	
22-1/2° ELBOW (SWXSW) 	6"	35-290100354			10" X 8"	35-290102512	
	8"	35-290100355			10" X 10"	35-290102513	
	10"	35-290100356			12" X 2"	35-290102514	
	12"	35-290100357			12" X 3"	35-290102515	
	15"	35-290100358			12" X 4"	35-290102516	
	18"	35-290100359			12" X 6"	35-290102517	
30° ELBOW (SWXSW) 	6"	35-290100474			12" X 8"	35-290102518	
	8"	35-290100475			12" X 10"	35-290102519	
	10"	35-290100476			12" X 12"	35-290102520	
	12"	35-290100477			15" X 2"	35-290102521	
	15"	35-290100478			15" X 3"	35-290102522	
	18"	35-290100479		15" X 4"	35-290102523		
45° ELBOW (SWXSW) 	6"	35-290100592		15" X 6"	35-290102524		
	8"	35-290100593		15" X 8"	35-290102525		
	10"	35-290100594		15" X 10"	35-290102526		
	12"	35-290100595		15" X 12"	35-290102527		
	15"	35-290100596		15" X 15"	35-290102528		
	18"	35-290100597		18" X 2"	35-290102529		
60° ELBOW (SWXSW) 	6"	35-290100702		18" X 3"	35-290102530		
	8"	35-290100703		18" X 4"	35-290102531		
	10"	35-290100704		18" X 6"	35-290102532		
	12"	35-290100705		18" X 8"	35-290102533		
	15"	35-290100706		18" X 10"	35-290102534		
	18"	35-290100707		18" X 12"	35-290102535		
				18" X 15"	35-290102536		
				18" X 18"	35-290102537		
				REDUCER COUPLER (SXS) 	8" X 6"	35-292958500	
			10" X 8"		35-292962800		
			12" X 10"		35-292967000		
			15" X 12"		35-292973200		

TITAN INDUSTRIES, INC.
a world of products for the world of water

Prices are subject to change without notice.
 Returns are subject to a restock fee.
 Special Orders are non-returnable.

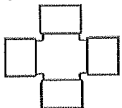
80# PIP SOLVENT WELD FITTINGS

Item	Size	Part No.	List Price	Item	Size	Part No.	List Price
CROSS (SXSXSXS) 	6" X 4"	35-290103285					
	6"	35-290103286					
	8"	35-290103291					
	10"	35-290103297					
	12"	35-290103304					
SLIP CAP (HEAT & AIR) 	12"	35-553001000					
	14"	35-553002000					
	15"	35-553003000					
	16"	35-553004000					







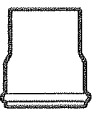

Prices are subject to change without notice.

Returns are subject to a restock fee.

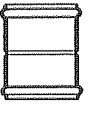
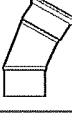
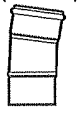
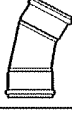
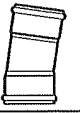
Special Orders are non-returnable.

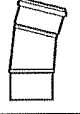
TITAN INDUSTRIES, INC.
a world of products for the world of water

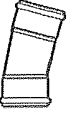
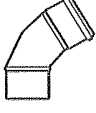
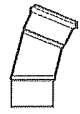
80# PIP GASKETED FITTINGS

Item	Size	Part No.	List Price	Item	Size	Part No.	List Price
COUPLER (GXSP) 	6"	35-290100068		22-1/2° ELBOW (GXG) 	6"	35-290100450	
	8"	35-290100069			8"	35-290100451	
	10"	35-290100070			10"	35-290100452	
	12"	35-290100071			12"	35-290100453	
	15"	35-290100072			15"	35-290100454	
	18"	35-290100073			18"	35-290100455	
COUPLER (GXG) 	6"	35-290100090		30° ELBOW (GXSP) 	6"	35-290100546	
	8"	35-290100091			8"	35-290100547	
	10"	35-290100092			10"	35-290100548	
	12"	35-290100093			12"	35-290100549	
	15"	35-290100094			15"	35-290100550	
	18"	35-290100095			18"	35-290100551	
11-1/4° ELBOW (GXSP) 	6"	35-290100186		30° ELBOW (GXSP) 	6"	35-290100570	
	8"	35-290100187			8"	35-290100571	
	10"	35-290100188			10"	35-290100572	
	12"	35-290100189			12"	35-290100573	
	15"	35-290100190			15"	35-290100574	
	18"	35-290100191			18"	35-290100575	
11-1/4° ELBOW (GXG) 	6"	35-290100210		45° ELBOW (GXSP) 	6"	35-290100658	
	8"	35-290100211			8"	35-290100659	
	10"	35-290100212			10"	35-290100660	
	12"	35-290100213			12"	35-290100661	
	15"	35-290100214			15"	35-290100662	
	18"	35-290100215			18"	35-290100663	
15° ELBOW (GXSP) 	6"	35-290100306		45° ELBOW (GXG) 	6"	35-290100680	
	8"	35-290100307			8"	35-290100681	
	10"	35-290100308			10"	35-290100682	
	12"	35-290100309			12"	35-290100683	
	15"	35-290100310			15"	35-290100684	
	18"	35-290100311			18"	35-290100685	
15° ELBOW (GXG) 	6"	35-290100330		60° ELBOW (GXSP) 	6"	35-290100768	
	8"	35-290100331			8"	35-290100769	
	10"	35-290100332			10"	35-290100770	
	12"	35-290100333			12"	35-290100771	
	15"	35-290100334			15"	35-290100772	
	18"	35-290100335			18"	35-290100773	
22-1/2° ELBOW (GXSP) 	6"	35-290100426		60° ELBOW (GXG) 	6"	35-290100790	
	8"	35-290100427			8"	35-290100791	
	10"	35-290100428			10"	35-290100792	
	12"	35-290100429			12"	35-290100793	
	15"	35-290100430			15"	35-290100794	
	18"	35-290100431			18"	35-290100795	

Prices are subject to change without notice.

Returns are subject to a restock fee.

Special Orders are non-returnable.





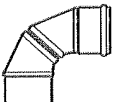
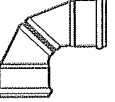
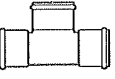

TITAN INDUSTRIES, INC.
a world of products for the world of water

80# PIP GASKETED FITTINGS

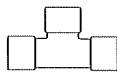
Item	Size	Part No.	List Price	Item	Size	Part No.	List Price
90° ELBOW (GXSP) 	6"	35-290100878					
	8"	35-290100879					
	10"	35-290100880					
	12"	35-290100881					
	15"	35-290100882					
	18"	35-290100883					
90° ELBOW (GXG) 	6"	35-290100900					
	8"	35-290100901					
	10"	35-290100902					
	12"	35-290100903					
	15"	35-290100904					
	18"	35-290100905					
TEE (GXGXG) 	6"X6"X6"	35-290103174					
	8"X8"X8"	35-290103179					
	10"X10"X10"	35-290103185					
	12"X12"X12"	35-290103192					
	15"X15"X15"	35-290103200					

*Prices are subject to change without notice.
 Returns are subject to a restock fee.
 Special Orders are non-returnable.*

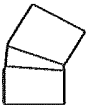
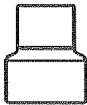

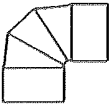
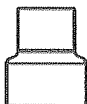
100# PIP SOLVENT WELD FITTINGS

Item	Size	Part No.	List Price	Item	Size	Part No.	List Price
COUPLER (SXS) 	6"	36-30010002		TEE (SXSXS) 	6" X 2"	36-300102499	
	8"	36-30010003			6" X 3"	36-300102500	
	10"	36-30010004			6" X 4"	36-300102501	
	12"	36-30010005			6" X 6"	36-300102502	
	15"	36-30010006			8" X 2"	36-300102503	
	18"	36-30010007			8" X 3"	36-300102504	
	21"	36-30010009			8" X 4"	36-300102505	
24"	36-30010010		8" X 6"		36-300102506		
11-1/4° ELBOW (SXS) 	6"	36-300100114			8" X 8"	36-300102507	
	8"	36-300100115			10" X 2"	36-300102508	
	10"	36-300100116			10" X 3"	36-300102509	
	12"	36-300100117			10" X 4"	36-300102510	
	15"	36-300100118			10" X 6"	36-300102511	
	18"	36-300100119			10" X 8"	36-300102512	
15° ELBOW (SXS) 	6"	36-300100234			10" X 10"	36-300102513	
	8"	36-300100235			12" X 2"	36-300102514	
	10"	36-300100236			12" X 3"	36-300102515	
	12"	36-300100237			12" X 4"	36-300102516	
	15"	36-300100238			12" X 6"	36-300102517	
	18"	36-300100239		12" X 8"	36-300102518		
22-1/2° ELBOW (SXS) 	6"	36-300100354		12" X 10"	36-300102519		
	8"	36-300100355		12" X 12"	36-300102520		
	10"	36-300100356		15" X 2"	36-300102521		
	12"	36-300100357		15" X 3"	36-300102522		
	15"	36-300100358		15" X 4"	36-300102523		
	18"	36-300100359		15" X 6"	36-300102524		
30° ELBOW (SXS) 	6"	36-300100474		15" X 8"	36-300102525		
	8"	36-300100475		15" X 10"	36-300102526		
	10"	36-300100476		15" X 12"	36-300102527		
	12"	36-300100477		15" X 15"	36-300102528		
	15"	36-300100478		REDUCER COUPLING (SXS) 	8" X 6"	36-300100928	
	18"	36-300100479			10" X 6"	36-300100930	
45° ELBOW (SXS) 	6"	36-300100592			10" X 8"	36-300100931	
	8"	36-300100593			12" X 8"	36-300100932	
	10"	36-300100594			12" X 10"	36-300100935	
	12"	36-300100595			15" X 12"	36-300100940	
	15"	36-300100596		18" X 15"	36-300100946		
	18"	36-300100597		21" X 18"	36-300100960		
90° ELBOW (SXS) 	6"	36-300100812		PIP X IPS REDUCER (SXS) 	8" x 4"	36-300101534	
	8"	36-300100813			12" X 8"	36-300101535	
	10"	36-300100814			6" X 4"	36-300101536	
	12"	36-300100815			8" X 6"	36-300101537	
	15"	36-300100816			10" X 8"	36-300101538	
	18"	36-300100817			12" X 10"	36-300101539	
				15" X 12"	36-300101540		
				IPS X PIP ADAPTER (SXS)	6"	36-300101649	
			8"		36-300101650		
			10"		36-300101651		
			12"		36-300101652		

TITAN INDUSTRIES, INC.
a world of products for the world of water

*Prices are subject to change without notice.
Returns are subject to a restock fee.
Special Orders are non-returnable.*

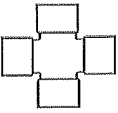
100# PIP SOLVENT WELD FITTINGS

Item	Size	Part No.	List Price	Item	Size	Part No.	List Price
CROSS SXSXSXS 	6" X 6"	36-300103286		160# IPS SLIP 90° ELBOW	12"	36-340100815	
	8" X 8"	36-300103291					
	10" X 10"	36-300103297					
	12" X 3"	36-300103299					
	12" X 12"	36-300103304					
	15" X 15"	36-300103321					
CAP (SLIP) 	6"	36-300107540		MULTI-STEP REDUCER	8"X3" (BxB)	36-300100927	
	8"	36-300107541					
	10"	36-300107542					
	12"	36-300107543					
	15"	36-300107545					
	16"	36-300107546					
	18"	36-300107547					
20"	36-300107549						
				PIP X IPS SADDLE	12" X 3"	36-293966310	
				SADDLE SLIP	8" X 8"	36-293908010	
				SADDLE	10" X 8"	36-300101817	
				REPAIR COUPLER	12" W/O CENTER STOP (G X G)	36-302812000	









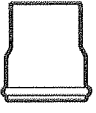

Prices are subject to change without notice.

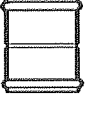
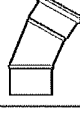
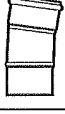
Returns are subject to a restock fee.

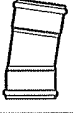
Special Orders are non-returnable.

TITAN INDUSTRIES, INC.
a world of products for the world of water

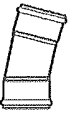
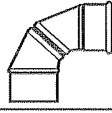
100# PIP GASKETED FITTINGS

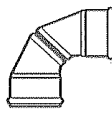
Item	Size	Part No.	List Price	Item	Size	Part No.	List Price
COUPLER (GXSP) 	6"	36-30010068		22-1/2° ELBOW (GXG) 	6"	36-300100450	
	8"	36-30010069			8"	36-300100451	
	10"	36-30010070			10"	36-300100452	
	12"	36-30010071			12"	36-300100453	
	15"	36-30010072			15"	36-300100454	
	18"	36-30010073			18"	36-300100455	
	21"	36-30010075					
COUPLER (GXG) 	6"	36-300100090		30° ELBOW (GXSP) 	6"	36-300100546	
	8"	36-300100091			8"	36-300100547	
	10"	36-300100092			10"	36-300100548	
	12"	36-300100093			12"	36-300100549	
	15"	36-300100094			15"	36-300100550	
	18"	36-300100095			18"	36-300100551	
	21"	36-300100097					
11-1/4° ELBOW (GXSP) 	6"	36-300100186		30° ELBOW (GXG) 	6"	36-300100570	
	8"	36-300100187			8"	36-300100571	
	10"	36-300100188			10"	36-300100572	
	12"	36-300100189			12"	36-300100573	
	15"	36-300100190			15"	36-300100574	
	18"	36-300100191			18"	36-300100575	
11-1/4° ELBOW (GXG) 	6"	36-300100210		45° ELBOW (GXSP) 	6"	36-300100658	
	8"	36-300100211			8"	36-300100659	
	10"	36-300100212			10"	36-300100660	
	12"	36-300100213			12"	36-300100661	
	15"	36-300100214			15"	36-300100662	
	18"	36-300100215			18"	36-300100663	
15° ELBOW (GXSP) 	6"	36-300100306		45° ELBOW (GXG) 	6"	36-300100680	
	8"	36-300100307			8"	36-300100681	
	10"	36-300100308			10"	36-300100682	
	12"	36-300100309			12"	36-300100683	
	15"	36-300100310			15"	36-300100684	
	18"	36-300100311			18"	36-300100685	
15° ELBOW (GXG) 	6"	36-300100330		90° ELBOW (GXSP) 	6"	36-300100878	
	8"	36-300100331			8"	36-300100879	
	10"	36-300100332			10"	36-300100880	
	12"	36-300100333			12"	36-300100881	
	15"	36-300100334			15"	36-300100882	
	18"	36-300100335			18"	36-300100883	
22-1/2° ELBOW (GXSP) 	6"	36-300100426		90° ELBOW (GXG) 	6"	36-300100900	
	8"	36-300100427			8"	36-300100901	
	10"	36-300100428			10"	36-300100902	
	12"	36-300100429			12"	36-300100903	
	15"	36-300100430			15"	36-300100904	
	18"	36-300100431			18"	36-300100905	



TITAN INDUSTRIES, INC.
a world of products for the world of water

Prices are subject to change without notice.

Returns are subject to a restock fee.

Special Orders are non-returnable.

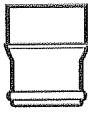
100# PIP GASKETED FITTINGS

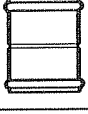
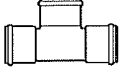
Item	Size	Part No.	List Price	Item	Size	Part No.	List Price
REDUCER COUPLING (GXSP) 	6" X 4"	36-300101310					
	8" X 6"	36-300101312					
	10" X 8"	36-300101315					
	12" X 10"	36-300101319					
	15" X 12"	36-300101324					
	18" X 15"	36-300101330					
REDUCER COUPLING (SPXG) 	6" X 4"	36-300101383					
	8" X 6"	36-300101385					
	10" X 8"	36-300101388					
	12" X 10"	36-300101392					
	15" X 12"	36-300101397					
IPS X PIP ADAPTER (GXG) 	6" X 6"	36-300101747					
	8" X 8"	36-300101748					
	10" X 10"	36-300101749					
	12" X 12"	36-300101750					
GASKETED TEE 	8"X8"X8"	36-300103179					
	10"X10"X10"	36-300103185					
	12"X12"X12"	36-300103192					

TITAN INDUSTRIES, INC.
a world of products for the world of water

*Prices are subject to change without notice.
Returns are subject to a restock fee.
Special Orders are non-returnable.*

IRRIGATION ACCESSORIES

Item	Size	Part No.	List Price	Item	Size	Part No.	List Price
MILLER	2"	37-DC1220IPS		LITTLE GIANT	6"	37-DC060PIP0	
IPS BOLTED	3"	37-DC1203IPS		PIP RICE	8"	37-DC080PIP0	
COUPLER	4"	37-DC1204IPS		BOLTED	10"	37-DC100PIP0	
12" PVC BODY				COUPLER	12"	37-DC120PIP0	
				12" BODY	14"	37-DC140PIP0	
				FIBER ENDS	15"	37-DC150PIP0	
NACO IPS	6"	37-DC060IPS0					
125# 12" PVC	8"	37-DC080IPS0		NACO PIP	6"	37-DC060PIP0	
BODY	10"	37-DC100IPS0		100# 12" PVC	8"	37-DC080PIP0	
FIBER ENDS	12"	37-DC120IPS0		BODY	10"	37-DC100PIP0	
				FIBER ENDS	12"	37-DC120PIP0	
NACO IPS	6"	37-DC3428060		BOLTED	14"	37-DC140PIP0	
160# 12" PVC	8"	37-DC3428080		COUPLER	15"	37-DC150PIP0	
BODY FIBER	10"	37DC3428100					
ENDS	12"	37DC3428120					
IPS BOLTED	4"	37-DCW040IPS		PIP BOLTED	6"	37-DCW060PIP	
WEDGE-TITE	5"	37-DCW050IPS		WEDGE-TITE	8"	37-DCW080PIP	
COUPLER	6"	37-DCW060IPS		COUPLER	10"	37-DCW100PIP	
6" BODY	8"	37-DCW080100		6" BODY	12"	37-DCW120PIP	
	10"	37-DCW100IPS					
	12"	37-DCW120IPS					
IPS BOLTED	4"	37-DCE040IPS		PIP BOLTED	4"	37-DCE040PIP	
WEDGE-TITE	5"	37-DCE050IPS		WEDGE-TITE	6"	37-DCE060PIP	
COUPLER	6"	37-DCE060IPS		COUPLER	8"	37-DCE080PIP	
10" BODY	8"	37-DCE080IPS		10" BODY	10"	37-DCE100PIP	
	10"	37-DCE100IPS			12"	37-DCE120PIP	
	12"	37-DCE120IPS			15"	37-DCE150PIP	
GHEEN IPS	4"	37-DCIPSS040		GHEEN OD	4"	37-DCODSS040	
6" BARREL	6"	37-DCIPSS060		6" BARREL	6"	37-DCODSS060	
DRESSER	8"	37-DCIPSS080		DRESSER	8"	37-DCODSS080	
COUPLER	10"	37-DCIPSS100		COUPLER	10"	37-DCODSS100	
GHEEN IPS	6"	37-DCIPSL040		GHEEN OD	6"	37-DCODSL060	
10" BARREL	8"	37-DCIPSL080		10" BARREL	8"	37-DCODSL080	
COUPLER	10"	37-DCIPSL100		COUPLER	10"	37-DCODSL100	
IPS STEEL	6"	37-DCS060IPS		PIP STEEL	6"	37-DCS060PIP	
CAST IRON	8"	37-DCS080IPS		CAST IRON	8"	37-DCS080PIP	
BOLTED	10"	37-DCS100IPS		BOLTED	10"	37-DCS100PIP	
COUPLER	12"	37-DCS120IPS		COUPLER	12"	37-DCS120PIP	
FRESNO	4"	37-DC120A040		BOLT SET	6"	37-BLTSETP06	
STEEL BODY	5"	37-DC120A050		FOR PVC	8"	37-BLTSETP08	
STEEL ENDS	6"	37-DC120A060		FLANGE	10"	37-BLTSETP10	
BOLTED	8"	37-DC120A080					
TRANSITION	10"	37-DC120A100		8" PIP FLANGE PACK		37-FLNPK08PI	
COUPLERS	12"	37-DC120A120					
FRESNO	6"	37-DC120C06P		PIP	6"	37-BASEIN060	
PVC BODY	8"	37-DC120C08P		INSERT	8"	37-BASEIN080	
STEEL ENDS	10"	37-DC120C10P		ADAPTER	12"	37-BASEIN120	
TRANSITON	12"	37-DC120C12P					
COUPLERS	15"	37-DC120C15P					

TITAN INDUSTRIES, INC.
a world of products for the world of water

*Prices are subject to change without notice.
Returns are subject to a restock fee.
Special Orders are non-returnable.*

IRRIGATION ACCESSORIES

Item	Size	Part No.	List Price	Item	Size	Part No.	List Price
AIR VENT	1"	37-AVP100000		BLACK	6" X 4"	37-CONBL0604	
MODEL	2"	37-AVP200000		CONCENTRIC	8" X 6"	37-CONBL0806	
AVP-1	3"	37-AVP300000		WELD-ON	10" X 8"	37-CONBL1008	
				CONE	12" X 10"	37-CONBL1210	
MODEL	1-1/2"	37-AV1500000		WELD-ON	8" X 10"	37-WDLRD8010	
AV-150	2"	37-AV2000000		REDUCER			
	3"	37-AV3000000					
	4"	37-AV4000000					
MODEL	2"	37-AVCR10102		BLACK	4"	37-RNGLKM040	
CR-101	3"	37-AVCR10103		WELD-ON	5"	37-RNGLKM050	
	4"	37-AVCR10104		MALE	6"	37-RNGLKM060	
				RINGLOCK	8"	37-RNGLKM080	
MODEL	1"	37-AVV100000			10"	37-RNGLKM100	
CRP-8	2"	37-AVV200000			12"	37-RNGLKM120	
	3"	37-AVV300000					
MODEL	2"	37-AVVC20000		WELD-ON	6"	37-WLDCLR060	
CRP-9				COLLAR	8"	37-WLDCLR080	
PRESSURE	2" AA-6A	37-AA6A20000		BLACK	4"	37-WLDTBL040	
RELIEF	3" AA-60A	37-AA60B3000		WELD-ON	6"	37-WLDTBL060	
VALVE	4" AA-60A	37-AA60B4000		TEE	8"	37-WLDTBL080	
					10"	37-WLDTBL100	
PIP EPOXY	6"	37-ESC060PIP		BLACK	4"	37-WLDNP0404	
WELD-ON	8"	37-ESC080PIP		HALF	6"	37-WLDNP0604	
STARTER	10"	37-ESC100PIP		NIPPLE	6" X 12" LONG	37-WLDNP0612	
COUPLER	12"	37-ESC120PIP					
	15"	37-ESC150PIP					
IPS EPOXY	4"	37-ESC040IPS		DRAW	4"	37-DB0400000	
WELD-ON	6"	37-ESC060IPS		BANDS	6"	37-DB0600000	
COUPLER	8"	37-ESC080IPS			8"	37-DB0800000	
	10"	37-ESC100IPS			10"	37-DB1000000	
	12"	37-ESC120IPS			12"	37-DB1200000	
	15"	37-ESC150IPS			14"	37-DB1400000	
	18"	37-ESC180IPS					
PIERCE	2"	37-SWOCFEM02		STEEL	6"	37-WGBAND060	
BLACK STEEL	4"	37-SWOCFEM04		WATERGATE	8"	37-WGBAND080	
FEMALE	6"	37-SWOCFEM06		BAND FOR PVC			
WELD ON	8"	37-SWOCFEM08					
STARTER	10"	37-SWOCFEM10		RINGLOCK	4"	43-212300800	
	12"	37-SWOCFEM12		CLAMP	6"	43-212300200	
					8"	43-212300300	
BLK FEMALE	4"	37-WLDCL40N4			10"	43-212300400	
STARTER WITH HALF NIPPLE					12"	43-212300500	
PIERCE	4"	37-SWOCMAL04		FLANGED	6"	OMGIRRFLEL060	
BLACK STEEL	6"	37-SWOCMAL06		STEEL	8"	OMGIRRFLEL080	
MALE	8"	37-SWOCMAL08		90 ELLBOW	10"	OMGIRRFLEL100	
WELD ON	10"	37-SWOCMAL10		IRRIGATION	6"	OMGIRRWYE0600	
STARTER	12"	37-SWOCMAL12		STEEL	8"	OMGIRRWYE0800	
				WYE	10"	OMGIRRWYE1000	
				IRRIGATION	8"	OMGIRRZDRP080	
				Z-DROP	10"	OMGIRRZDRP100	

Prices are subject to change without notice.

Returns are subject to a restock fee.

Special Orders are non-returnable.

TITAN INDUSTRIES, INC.
a world of products for the world of water

IRRIGATION ACCESSORIES

Item	Size	Part No.	List Price	Item	Size	Part No.	List Price	
GHEEN FABRICATED IRRIGATION	6" 8" 10"	OMGIRRFVLV060 OMGIRRFVLV080 OMGIRRFVLV100		VALVE STUBS				
VALVE FLANGED OR COUPLED				4" CAST IRON				37-VALSTB040
				8" X 9" GALV. CLAMP-LOCK				37-CLVSTUB08
PIERCE BUTTERFLY LINE VALVE PLAIN END GALV	4" 6" 8" 10"	37-BFLYPE004 37-BFLYPE006 37-BFLYPE008 37-BFLYPE010		GALV. VALVE OPENING ELBOW BAND & LATCH STYLE	4" X 4" 6" X 6" 8" X 8" 10" X 10"	37-VOELL0404 37-VOELL0606 37-VOELL0808 37-VOELL1010		
PIERCE BUTTERFLY LINE VALVE CIRCLE LOCK	4" 6" 8" 10"	37-BFLYCL004 37-BFLYCL006 37-BFLYCL008 37-BFLYCL010		GALV HOSE BARB	4" FEMALE	37-HSBRBGF04		
VBE2-W BUTTERFLY VALVE LEVER OPERATED	4" 6" 8" 10" 12"	37-BFLYWF004 37-BFLYWF006 37-BFLYWF008 37-BFLYWLO10 37-BFLYWLO12		BLACK HOSE BARB	4" MALE 6" MALE 10" MALE	37-HSBRBBM04 37-HSBRBBM06 37-HSBRBBM10		
VBE2-W BUTTERFLY VALVE W/GEAR & HANDWHEEL	4" 6" 8" 10" 12"	37-BFLYWF004 37-BFLYWF006 37-BFLYWFG08 37-BFLYWF010 37-BFLYWF012		ALUMINUM END PLUG	8" 10"	37-AEP080000 37-AEP100000		
BUTTERFLY VALVE EXTENTION	48" 72" 96"	37-BFLYWFE4 37-BFLYWFE6 37-BFLYWFE8		ALUMINUM KROY COUPLER	6" 8" 10"	37-AKC060000 37-AKC080000 37-AKC100000		
CAST IRON BUTTERFLY VALVE WITH DUCTILE DISC	3" 4" 6" 8"	37-BFYB3RLO3 37-BFYB3RLO4 37-BFYB3RW06 37-BFYB3RLO8		BAND & LATCH	4" 6" 8" 10"	37-BANLAT040 37-BANLAT060 37-BLB080000 37-BLB100000		
TYPE 4 SUNSHINE ACME ALFALFA VALVE	6" 8" 10" 12"	37-ALFV06000 37-ALFV08000 37-ALFV10000 37-AFLV12000		DAM GATES				37-DAMGATES0
COMPLETE COVER FOR TYPE 4 VALVE	8" 10" 12"	37-ALFL08000 37-ALFL10000 37-ALFL12000		KEY HOLE GATES				37-KEYGATES0
FLOW METERS	4" FLANGED 6" 8"	37-FLFLWMT04 37-FLWMET060 37-FLWMET080		PIPE JOINT LUBRICANT	QUART GALLON	37-LUBEQT000 37-LUBEGAL00		
MW500 SERIES PROPELLER METER	4"	37-FLMWMET04		ALUMINUM SWING CHECK	8" 10"	37-SWCK080AL 37-SWCK100AL		

TITAN INDUSTRIES, INC.
a world of products for the world of water

*Prices are subject to change without notice.
Returns are subject to a restock fee.
Special Orders are non-returnable.*

SURFACE FITTINGS

Item	Size	Part No.	List Price	Item	Size	Part No.	List Price
FIELD TEE GXGXSP	6"	38-250106022		COUPLER BXS	6"	38-252406013	
	8"	38-250108022			8"	38-252408130	
	10"	38-250110022			10"	38-252410013	
	12"	38-250112022			12"	38-252412013	
LINE TEE GXSXG	6"	38-250106023		INCREASER GXS	8" X 6"	38-253258523	
	8"	38-250108023			10" X 8"	38-253262823	
	10"	38-250110023			12" X 10"	38-253267023	
	12"	38-250112023					
22-1/2° ELBOW GXS	6"	38-251206023		REDUCER SXG	8" X 6"	38-253258532	
	8"	38-251208023			10" X 8"	38-253262832	
	10"	38-251210023			12" X 10"	38-253267032	
	12"	38-251212023					
45° ELBOW GXS	6"	38-251406023		BUTTERFLY VALVE GXS	6"	38-254206023	
	8"	38-251408023			8"	38-254208023	
	10"	38-251410023			10"	38-254210023	
	12"	38-251412023			12"	38-254212023	
90° ELBOW GXS	6"	38-251606023		END CAP SW	6"	38-254706010	
	8"	38-251608023			8"	38-254708010	
	10"	38-251610023			12"	38-254712010	
	12"	38-251612023					
COUPLER BXB	6"	38-252406010		END CAP GXCAP	6"	38-254706020	
	8"	38-252408010			8"	38-254708020	
	10"	38-252410010			10"	38-254710020	
	12"	38-252412010			12"	38-254712020	
COUPLER BXG	6"	38-252406012		END PLUG	6"	38-254806030	
	8"	38-252408012			8"	38-254808030	
	10"	38-252410012			10"	38-254810030	
	12"	38-252412012			12"	38-254812030	
SQUARE HEAD GASKET- SURFACE	12"	38-301400070		STARTER COUPLER GXS	6" X 3'	38-259006023	
			8" X 3'		38-259008023		
			10" X 3'		38-259010023		
			12" X 3'		38-259012023		

TITAN INDUSTRIES, INC.
a world of products for the world of water

*Prices are subject to change without notice.
Returns are subject to a restock fee.
Special Orders are non-returnable.*

JCM CLAMPS

Item	Size	Part No.	List Price	Item	Size	Part No.	List Price	
UNIVERSAL CLAMP	1/2" X 3"	43-101008430		S STEEL UNIVERSAL CLAMP	4" X 12"	43-131048012		
	1-1/4" X 6"	43-101016660			COUPLER	4" X 15"	43-131048015	
STANDARD RANGE 101 JCM UNIVERSAL CLAMP COUPLER	1-1/2" X 6"	43-101019060		6" X 12"		43-131066312		
	4" X 12"	43-101048012		6" X 12"		43-131069012		
	4" X 18"	43-101048018		6" X 15"		43-131069015		
	4" X 30"	43-101048030		8" X 12"		43-131080012		
	6" X 7-1/2"	43-101060070		8" X 15"		43-131080015		
	6" X 12"	43-101069012		8" X 12"		43-131090512		
	8" X 6"	43-101080060		10" X 12"		43-131107512		
	8" X 7-1/2"	43-101080070		12" X 15"		43-131127512		
	8" X 12"	43-101080012						
	8" X 6"	43-101086360						
	8" X 12"	43-101090512						
	8" X 15"	43-101090515						
	10" X 7-1/2"	43-101100070						
10" X 18"	43-101111018							
12" X 7-1/2"	43-101120070							
12" X 18"	43-101127518							
105 COLLAR LEAK CLAMP	4" X 6"	43-105045060		FLANGED COUPLER ADAPTER	4" 6" W/SET SCREWS	43-301048000 43-301069000		
	6" X 6"	43-105061460						
	8" X 6"	43-105081660						
	8" X 7"	43-105508637						
	10" X 6"	43-105102060						
	12" X 6"	43-105122460						
110 PATCH CLAMP GALV. BOLTS	1/2" X 3"	43-110008430		#418 THRD TAPPING SLEEVE	14"X4"OUTLET	43-418153018		
	1/2" X 6"	43-110008460		PLEASE CALL FOR OTHER SIZES PRICES AND AVAILABILITY				
	3/4" X 3"	43-110010530						
	3/4" X 6"	43-110010560						
	1" X 3"	43-110013230						
	1" X 6"	43-110013260						
	1-1/4" X 3"	43-110016630						
	1-1/4" X 6"	43-110016660						
	1-1/2" X 3"	43-110019030						
	1-1/2" X 6"	43-110019060						
	2" X 3"	43-110023830						
	2" X 6"	43-110023860						
	2" X 9"	43-110023890						
	2" X 12"	43-110023812						
	4" X 12"	43-110045012						
WRAP AROUND CLAMP	1" X 3"	43-101013230						
	2" X 9"	43-115028990						
BELL JOINT LEAK CLAMP	6"	43-106066300						
SS DOUBLE BAND CLAMP	12" X 18"	43-102132018						
	14" X 18"	43-132153018						

TITAN INDUSTRIES, INC.
a world of products for the world of water

*Prices are subject to change without notice.
Returns are subject to a restock fee.
Special Orders are non-returnable.*

PAC-N-VAC - WELL PACKER SYSTEM

Item	Size	Part No.	List Price	
16" Well/10" Column Pipe		PNV160C10TC	5,130.00	Custom Packers can be built to suit your unique needs. The following are necessary for custom placement. - Current Production - Best Recorded Production - Last Work-Over - Total Depth - Depth of Pump - Screen Information - Engine/Motor Information - Irrigation Method - Preferred Well Service Company Contact Information - Downhole Video Available?
16" Well/8" Column Pipe		PNV160C08TC	4,990.00	
16" Well/6" Column Pipe		PNV160C06TC	4,870.00	
12" Well/8" Column Pipe		PNV120C08TC	4,740.00	
12" Well/6" Column Pipe		PNV120C06TC	4,620.00	
12" Well/4" Column Pipe		PNV120C04TC	4,540.00	
10" Well/6" Column Pipe		PNV100C06TC	4,440.00	
10" Well/4" Column Pipe		PNV100C04TC	4,360.00	
8" Well/4" Column Pipe		PNV080C04TC	4,340.00	
Prices for all packers are for units installed on 10' column pipe, threaded both ends (including one coupler).				

PUMPING IRRIGATION WATER GETS EASIER IF YOU KEEP THE AIR OUT OF YOUR PUMP.

PAC-N-VAC offers a simple solution to stop surface air from entering water wells.

1. AERATION Lowers Pump Efficiency.
Pac-N-Vac Packers STOP THE EASY AIR from getting down to your pump.
2. Target Your Pump Efficiency Curves.
Pac-N-Vac Packers use natural forces to increase water flow through the screen.
3. Increasing Water Inflow to Your Pump Requires More Water Pressure Outside the Screen, and a Vacuum inside the Well.

Put both forces to work in your wells with the Pac-N-Vac Packers.
More water with reduced costs makes happy customers for your company.

Pac-N-Vac Irrigation Well Packers are self-inflated.
They expand when the well is pumping and shrink when the well is off.

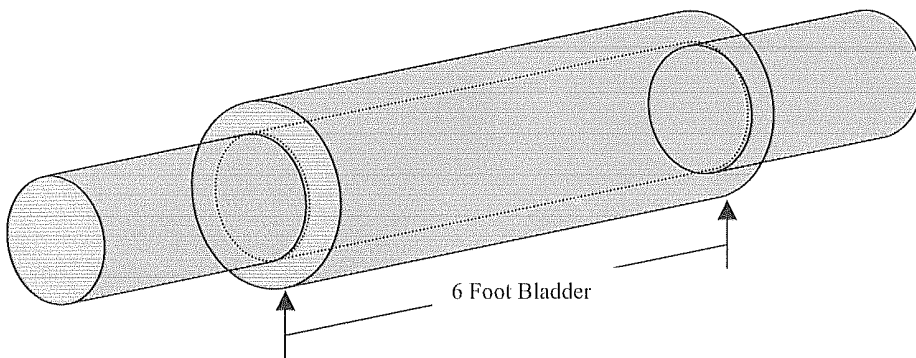

Prices are subject to change without notice.

Returns are subject to a restock fee.

Special Orders are non-returnable.

TITAN INDUSTRIES, INC.
a world of products for the world of water

PIP PIPE SPECIFICATIONS

PART NO.	Size & SDR/Schedule	PSI	Wall	O.D.	I.D.	Wt./Ft.
PIP040C10020G	4" SDR 41	100	.101	4.13	3.928	.86
PIP060C02220G	6" Low Head	22	.070	6.14	6.000	.96
PIP060C05020G	6" SDR 81	50	.076	6.14	5.988	1.10
PIP060C08020G	6" SDR 51	80	.120	6.14	5.900	1.49
PIP060C10020G	6" SDR 41	100	.150	6.14	5.840	1.85
PIP060C12520G	6" SDR 32.5	125	.189	6.14	5.762	2.33
PIP060C02220G	8" Low Head	22	.080	8.16	8.000	1.38
PIP080C05020G	8" SDR 81	50	.101	8.16	7.958	1.77
PIP080C08020G	8" SDR 51	80	.160	8.16	7.840	2.64
PIP080C10020G	8" SDR 41	100	.199	8.16	7.762	3.27
PIP080C12520G	8" SDR 32.5	125	.251	8.16	7.658	4.20
PIP100C02220G	10" Low Head	22	.100	10.20	10.000	2.15
PIP100C05020G	10" SDR 81	50	.126	10.20	9.948	2.75
PIP100C08020G	10" SDR 51	80	.200	10.20	9.800	4.13
PIP100C10020G	10" SDR 41	100	.249	10.20	9.702	5.11
PIP100C12520G	10" SDR 32.5	125	.314	10.20	9.572	6.40
PIP120C02220G	12" Low Head	22	.120	12.24	12.000	3.10
PIP120C05020G	12" SDR 81	50	.151	12.24	11.938	3.94
PIP120C08020G	12" SDR 51	80	.240	12.24	11.760	6.03
PIP120C10020G	12" SDR 41	100	.299	12.24	11.642	7.47
PIP120C12520G	12" SDR 32.5	125	.377	12.24	11.486	9.44
PIP140C02220G	14" Low Head	22	.140	14.28	14.000	4.22
PIP140C05020G	14" SDR 81	50	.177	14.28	13.926	5.32
PIP140C08020G	14" SDR 51	80	.280	14.28	13.720	7.94
PIP150C02220G	15" Low Head	22	.150	15.30	15.000	4.84
PIP150C05020G	15" SDR 81	50	.189	15.30	14.922	6.08
PIP150C12520G	15" SDR 51	80	.300	15.30	14.700	9.44
PIP150C10020G	15" SDR 41	100	.375	15.30	14.550	11.67
PIP150C12520G	15" SDR 32.5	125	.471	15.30	14.358	15.00
PIP180C08020G	18" SDR 51	80	.367	18.701	17.967	14.14
PIP180C10020G	18" SDR 41	100	.456	18.701	17.789	17.73
PIP180C12520G	18" SDR 32.5	125	.575	18.701	17.551	22.13
PIP210C08020G	21" SDR 51	80	.432	22.047	21.183	19.89
PIP210C10020G	21" SDR 41	100	.538	22.047	20.971	24.65
PIP210C12520G	21" SDR 32.5	125	.678	22.047	20.691	30.76
PIP240C08020G	24" SDR 51	80	.486	24.803	23.831	25.28
PIP240C10020G	24" SDR 41	100	.605	24.803	23.593	31.31
PIP240C12520G	24" SDR 32.5	125	.763	24.803	23.277	39.33
PIP270C08020G	27" SDR 51	80	.548	27.953	26.857	32.66
PIP270C10020G	27" SDR 41	100	.682	27.953	26.589	39.85
PIP270C12520G	27" SDR 32.5	125	.860	27.953	26.233	46.49
PLEASE CALL FOR PRICING & AVAILABILITY.						

TITAN INDUSTRIES, INC.
a world of products for the world of water

Prices are subject to change without notice.

Returns are subject to a restock fee.

Special Orders are non-returnable.

SURFACE TUBE SPECIFICATIONS

HEAVY-WALL SURFACE TUBE						
PART NO.	Size	PSI	Wall	O.D.	I.D.	Wt./Ft.
PIP060SURHEVY	6"	< 20	.120	6.00	5.76	1.50
PIP080SURHEVY	8"	< 20	.120	8.00	7.76	2.00
PIP100SURHEVY	10"	< 20	.120	10.00	9.76	2.50
PIP120SURHEVY	12"	< 20	.120	12.00	11.76	3.00
LIGHT-WALL SURFACE TUBE						
PIP060SURLITE	6"	< 20	.090	6.00	5.82	1.25
PIP080SURLITE	8"	< 20	.090	8.00	7.82	1.60
PIP100SURLITE	10"	< 20	.090	10.00	9.82	2.10
GATED HEAVY & LIGHT SURFACE TUBE						
PIP060SURHEVG	6" HEAVY GATED	HEAVY & LIGHT-WALL SURFACE TUBE IS AVAILABLE IN PLAIN OR GATED. STANDARD GATE SPACINGS ARE 20", 30", 36" & 40"				
PIP060SURLITG	6" LITE GATED					
PIP080SURHEVG	8" HEAVY GATED					
PIP080SURLITG	8" LITE GATED					
PIP100SURHEVG	10" HEAVY GATED					
PIP100SURLITG	10" LITE GATED					
PIP100SURHEVG	12" HEAVY GATED					
<p>HEAVY & LIGHT-WALL COME IN STANDARD LENGTHS OF 30'.</p> <p>PLEASE CALL FOR PRICING & AVAILABILITY.</p>						

SPRINKLERS & ACCESSORIES

DESCRIPTION	PART No.	List Price
HUNTER ROTOR HEADS		
4" POP-UP ROTOR HEAD ADJUSTABLE ARC	44-PGM04A000	
4" POP-UP ROTOR HEAD ADJUSTABLE ARC NO CHECK VALVE	44-PGPADJ000	
4" POP-UP ROTOR HEAD LOW-ANGLE ADJUST. ARC NO CHECK VALVE	44-PGPADJLA0	
4" POP-UP ROTOR HEAD FULL CIRCLE NO CHECK VALVE	44-PGP360000	
4" POP-UP ROTOR HEAD W/PLASTIC RISER NO CHECK VALVE	44-I20ADJ000	
4" POP-UP ROTOR HEAD W/PLASTIC RISER & CHECK VALVE	44-I20ADV000	
4" POP-UP ROTOR HEAD W/SS RISER & CHECK VALVE	44-I20ADS000	
3-1/2" POP-UP ROTOR HEAD W/PLASTIC RISER & CHECK VALVE	44-I25ADV000	
3-1/2" POP-UP ROTOR HEAD W/SS RISER & CHECK VALVE	44-I25ADS000	
PGP STANDARD RED NOZZLE TREE	44-PGPSTDRED	
PGP LOW ANGLE GRAY NOZZLE TREE	44-LAGRAYNOZ	
HUNTER SPRAY HEADS		
2" POP-UP SPRAY HEAD 10' RADIUS ADJUSTABLE ARC	44-PS0210A00	
2" POP-UP SPRAY HEAD 12' RADIUS ADJUSTABLE ARC	44-PS0212A00	
2" POP-UP SPRAY HEAD 15' RADIUS ADJUSTABLE ARC	44-PS0215A00	
2" POP-UP SPRAY HEAD 5' X 30' SIDE STRIP	44-PS025SS00	
4" POP-UP SPRAY HEAD 10' RADIUS ADJUSTABLE ARC	44-PS0410A00	
4" POP-UP SPRAY HEAD 12' RADIUS ADJUSTABLE ARC	44-PS0412A00	
4" POP-UP SPRAY HEAD 15' RADIUS ADJUSTABLE ARC	44-PS0415A00	
4" POP-UP SPRAY HEAD 5' X 30' SIDE STRIP	44-PS045SS00	
HUNTER VALVES & CONTROLLERS		
1" PLASTIC GLOBE ELECTRIC VALVE W/O FLOW CONTROL S X S	44-SRV100GS0	
6-STATION INDOOR CONTROLLER	44-SRC600I00	
9-STATION INDOOR CONTROLLER	44-SRC900I00	
8-STATION OUTDOOR CONTROLLER W/PLASTIC CABINET	44-ICC800PL0	
4-STATION MODULE	44-ICM400000	
8-STATION MODULE	44-ICM800000	
MIN-CLIK RAIN SENSOR	44-MINI-CLIK	
RAIN BIRD SPRAY HEADS & NOZZLES		
1802 2" POP-UP SPRAY HEAD 4" LENGTH	44-180200000	
1803 3" POP-UP SPRAY HEAD 4-7/8" LENGTH	44-180300000	
1804 4" POP-UP SPRAY HEAD 6" LENGTH	44-180400000	
1806 6" POP-UP SPRAY HEAD 9-3/8" LENGTH	44-180600000	
1812 12" POP-UP SPRAY HEAD 16" LENGTH	44-181200000	
R8F NOZZLE (FULL - 360°)	44-R8F000000	
R8H NOZZLE (1/2 ARC - 180°)	44-R8H000000	
R8Q NOZZLE (1/4 ARC - 90°)	44-R8Q000000	
R8T NOZZLE (1/3 ARC - 120°)	44-R8T000000	
R10F NOZZLE (FULL - 360°)	44-R10F00000	
R10H NOZZLE (1/2 ARC - 180°)	44-R10H00000	
R10Q NOZZLE (1/4 ARC - 90°)	44-R10Q00000	
R10T NOZZLE (1/3 ARC - 120°)	44-R10T00000	
R12F NOZZLE (FULL - 360°)	44-R12F00000	
R12TQ NOZZLE (3/4 ARC - 270°)	44-R12TQ0000	
R12TT NOZZLE (2/3 ARC - 240°)	44-R12TT0000	
R12H NOZZLE (1/2 ARC - 180°)	44-R12H00000	
R12T NOZZLE (1/3 ARC - 120°)	44-R12T00000	
R12Q NOZZLE (1/4 ARC - 90°)	44-R12Q00000	
R15F NOZZLE (FULL - 360°)	44-R15F00000	
R15TQ NOZZLE (3/4 ARC - 270°)	44-R15TQ0000	
R15TT NOZZLE (2/3 ARC - 240°)	44-R15TT0000	

TITAN INDUSTRIES, INC.

a world of products for the world of water

Prices are subject to change without notice.

Returns are subject to a restock fee.

Special Orders are non-returnable.

SPRINKLERS & ACCESSORIES

DESCRIPTION	PART No.	List Price
RAIN BIRD SPRAY HEADS & NOZZLES		
R15H NOZZLE (1/2 ARC - 180°)	44-R15H00000	
R15T NOZZLE (1/3 ARC - 120°)	44-R15T00000	
R15Q NOZZLE (1/4 ARC - 90°)	44-R15Q00000	
R15EST NOZZLE (4' X 15' END STRIP)	44-R15EST000	
R15CST NOZZLE (4' X 30' CENTER STRIP)	44-R15CST000	
R15SST NOZZLE (4' X 30' SIDE STRIP)	44-R15SST000	
R15SQ NOZZLE (23' X 23' SQUARE PATTERN)	44-R15SQ0000	
R9SST NOZZLE (9' X 18' SIDE STRIP)	44-R9SST0000	
R4VAN NOZZLE (VARIABLE ARC)	44-R4VAN0000	
R6VAN NOZZLE (VARIABLE ARC)	44-R6VAN0000	
R8VAN NOZZLE (VARIABLE ARC)	44-R8VAN0000	
R10VAN NOZZLE (VARIABLE ARC)	44-R10VAN000	
R12VAN NOZZLE (VARIABLE ARC)	44-R12VAN000	
R15VAN NOZZLE (VARIABLE ARC)	44-R15VAN000	
R18VAN NOZZLE (VARIABLE ARC)	44-R18VAN000	
PA8S PLASTIC SHRUB ADAPTER	44-PA8S00000	
1800EXT 6" RISER EXTENSION	44-1800EXT00	
RAIN BIRD ROTOR HEADS		
5004FC FULL CIRCLE	44-5004FC000	
5004PC PART CIRCLE	44-5004PC000	
R50 1.5 ROTOR HEAD W/RAIN CURTAIN NOZZLE	44-R50RC1500	
R50 2.0 ROTOR HEAD W/RAIN CURTAIN NOZZLE	44-R50RC2000	
R50 3.0 ROTOR HEAD W/RAIN CURTAIN NOZZLE	44-R50RC3000	
MAXI-PAW 3" POP-UP IMPACT SPRINKLER	44-2045A0800	
MAXI-BIRD IMPACT SPRINKLER	44-2045PJ080	
POP-A-WAY WRENCH FOR 15111	44-410450000	
MINI/MAXI PAW WRENCH	44-420640000	
RAIN BIRD VALVES		
100DV 1" ELECTRIC VALVE FT X FT	44-100DV0000	
100DVSS 1" ELECTRIC VALVE S X S	44-100DVSS00	
RAIN BIRD CONTROLLERS		
RC4BI 4 STATION INDOOR MECH CONTROLLER	44-RC4BI0000	
RC7BI 7 STATION INDOOR MECH CONTROLLER	44-RC7BI0000	
ESP4SI 4 STATION INDOOR CONTROLLER	44-ESP4SI000	
ESP6SI 6 STATION INDOOR CONTROLLER	44-ESP6SI000	
ESP8SI 8 STATION INDOOR CONTROLLER	44-ESP8SI000	
ESP12LXI 12 STATION INDOOR CONTROLLER	44-ESP12LXI0	
ESP16LXI 16 STATION INDOOR CONTROLLER	44-ESP16LXI0	
ESP4 4 STATION OUTDOOR CONTROLLER	44-ESP400000	
ESP6 6 STATION OUTDOOR CONTROLLER	44-ESP600000	
ESP8 8 STATION OUTDOOR CONTROLLER	44-ESP800000	
ESP12LX 12 STATION OUTDOOR CONTROLLER	44-ESP12LX00	
ESP16LX 16 STATION OUTDOOR CONTROLLER	44-ESP16LX00	
EASYRAIN SINGLE VALVE BATTERY CONTROLLER	44-EASYRAIN0	
RAIN BIRD ACCESSORIES		
1/2 SWING PIPE MALE ADAPTER	44-SBA050000	
3/4 SWING PIPE MALE ADAPTER	44-SBA075000	
SWING PIPE COUPLING	44-SBCPLG000	
1/2 SWING PIPE MALE 90° ELL	44-SBE050000	

TITAN INDUSTRIES, INC.
a world of products for the world of water

Prices are subject to change without notice.

Returns are subject to a restock fee.

Special Orders are non-returnable.

SPRINKLERS & ACCESSORIES

DESCRIPTION	PART No.	List Price
RAIN BIRD ACCESSORIES CONT.		
3/4 SWING PIPE MALE 90° ELL	44-SBE075000	
1/2 SWING PIPE FEMALE 90° ELL	44-SBFE05000	
SWING PIPE TEE	44-SBTEE0000	
IRRITROL 1/2" SUPER BLUE FLEX PIPE	44-EHD129501	
TORO SPRAY HEADS & NOZZLES		
570Z-3P POP-UP SPRAY HEAD	44-893977000	
570Z-4P POP-UP SPRAY HEAD	44-893978000	
570Z-12P SI POP-UP SPRAY HEAD	44-893982000	
15F-PC NOZZLE (FULL - 360°)	44-891401000	
15TQ-PC NOZZLE (3/4 ARC - 270°)	44-891404000	
15TT-PC NOZZLE (2/3 ARC - 240°)	44-891407000	
15H-PC NOZZLE (1/2 ARC- 180°)	44-891410000	
15T-PC NOZZLE (1/3 ARC- 120°)	44-891413000	
15Q-PC NOZZLE (1/4 ARC - 90°)	44-891416000	
12F-PC NOZZLE (FULL - 360°)	44-891419000	
12TQ-PC NOZZLE (3/4 ARC - 270°)	44-891422000	
12TT-PC NOZZLE (2/3 ARC - 240°)	44-891425000	
12H-PC NOZZLE (1/2 ARC - 180°)	44-891428000	
12T-PC NOZZLE (1/3 ARC - 120°)	44-891431000	
12Q-PC NOZZLE (1/4 ARC - 90°)	44-891434000	
10F-PC NOZZLE (FULL - 360°)	44-891437000	
10TQ-PC NOZZLE (3/4 ARC - 270°)	44-891440000	
10TT-PC NOZZLE (2/3 ARC - 240°)	44-891443000	
10H-PC NOZZLE (1/2 ARC - 180°)	44-891446000	
10T-PC NOZZLE (1/3 ARC - 120°)	44-891449000	
10Q-PC NOZZLE (1/4 ARC - 90°)	44-891452000	
8F-PC NOZZLE (FULL - 360°)	44-145500000	
8TQ-PC NOZZLE (3/4 ARC - 270°)	44-891458000	
8TT-PC NOZZLE (2/3 ARC - 240°)	44-891461000	
8H-PC NOZZLE (1/2 ARC - 180°)	44-891464000	
8T-PC NOZZLE (1/3 ARC- 120°)	44-891467000	
8Q-PC NOZZLE (1/4 ARC - 90°)	44-891470000	
4CST-PC NOZZLE (4' X 30' CENTER STRIP)	44-891497000	
4EST-PC NOZZLE (4' X 15' END STRIP)	44-891500000	
4SST-PC NOZZLE (4' X 30' SIDE STRIP)	44-891503000	
9SST-PC NOZZLE (9' X 18' SIDE STRIP)	44-891506000	
4S-SST-PC NOZZLE (4' X 18' SIDE STRIP)	44-891509000	
2S-SST-PC NOZZLE (2' X 6' SIDE STRIP)	44-891512000	
TVAN-8 NOZZLE (VARIABLE ARC)	44-TVAN80000	
TVAN-10 NOZZLE (VARIABLE ARC)	44-TVAN10000	
TVAN-12 NOZZLE (VARIABLE ARC)	44-TVAN12000	
TVAN-15 NOZZLE (VARIABLE ARC)	44-TVAN15000	
TVAN-17 NOZZLE (VARIABLE ARC)	44-TVAN17000	
TORO ROTOR HEADS		
S700PC ROTOR HEAD L/NOZZLE	44-358911000	
S700F ROTOR HEAD L/NOZZLE	44-358910000	
1.5 GPM STD ANGLE NOZZLE S700	44-890893L00	
2.0 GPM STD ANGLE NOZZLE S700	44-890894L00	
3.0 GPM STD ANGLE NOZZLE S700	44-890895L00	
4.5 GPM STD ANGLE NOZZLE S700	44-890896L00	

TITAN INDUSTRIES, INC.
a world of products for the world of water

Prices are subject to change without notice.

Returns are subject to a restock fee.

Special Orders are non-returnable.

SPRINKLERS & ACCESSORIES

DESCRIPTION	PART No.	List Price
TORO ROTOR HEADS CONT.		
6.0 GPM STD ANGLE NOZZLE S700	44-890897L00	
1.5 GPM LOW ANGLE NOZZLE S700	44-891093L00	
2.0 GPM LOW ANGLE NOZZLE S700	44-891095L00	
3.0 GPM LOW ANGLE NOZZLE S700	44-891097L00	
4.5 GPM LOW ANGLE NOZZLE S700	44-891099L00	
6.0 GPM LOW ANGLE NOZZLE S700	44-891101L00	
TORO ACCESSORIES		
570S TORO SHRUB ADAPTER	44-968070000	
6" RISER EXTENSION 570-6X	44-352636000	
6" STATIONARY RISER 570-SR-6	44-352631000	
18" STATIONARY RISER 570SR-18	44-570SR1800	
1/2X3/4X6 POLY CUT OFF RISER 850-49	44-850490000	
IRRITROL VALVES & REPAIR KITS		
1" ELECTRIC GLOBE RESIDENTIAL VALVE S X S	44-2400S0000	
1" ELECTRIC GLOBE RESIDENTIAL VALVE NPT X NPT	44-2400T0000	
1" ELECTRIC ANGLE RESIDENTIAL VALVE NPT X NPT	44-2600T0000	
1-1/2" ELECTRIC GLOBE/ANGLE COMMERCIAL VALVE NPT X NPT	44-216B00000	
2" ELECTRIC GLOBE/ANGLE COMMERCIAL VALVE NPT X NPT	44-217B00000	
24V AC, .4 AMP INRUSH, .2 AMP SOLENOID	44-R81124VAC	
1" VALVE REPAIR KIT 100 SERIES	44-SPK100100	
1-1/2" VALVE REPAIR KIT 100 SERIES	44-SPK100150	
2" VALVE REPAIR KIT 100 SERIES	44-SPK100200	
IRRITROL CONTROLLERS		
RD600INT 6 STATION INDOOR CONTROLLER	44-RD600INT0	
RD900INT 9 STATION INDOOR CONTROLLER	44-RD900INT0	
RD1200INT 12 STATION INDOOR CONTROLLER	44-RD1200INT	
RD600EXT 6 STATION OUTDOOR CONTROLLER	44-RD600EXT0	
RD900EXT 9 STATION OUTDOOR CONTROLLER	44-RD900EXT0	
RD1200EXT 12 STATION OUTDOOR CONTROLLER	44-RD1200EXT	
SR-1 PUMP START RELAY	44-SR1000000	
SADDLES		
3/4" X 1/2" BRASS SADDLE TEE FOR POLY	44-HBST03412	
1" X 1/2" BRASS SADDLE TEE FOR POLY	44-HBST10012	
1" X 3/4" BRASS SADDLE TEE FOR POLY	44-HBST10034	
1-1/4" X 3/4" BRASS SADDLE TEE FOR POLY	44-HBST11434	
1-1/2" X 3/4" BRASS SADDLE TEE FOR POLY	44-HBST11234	
2" X 3/4" BRASS SADDLE TEE FOR POLY	44-HBST20034	
3/4X1/2 DAWN SADDLE TEE	21-DT3/4X12	
1X1/2 DAWN SADDLE TEE	21-DST1X1/20	
1-1/4X1/2 DAWN SADDLE TEE	21-DST11/4X1	
1-1/4X3/4 DAWN SADDLE TEE	21-DST11/4X3	
1" X 1/2" BS SERIES BLAZING SADDLE FOR POLY	44-BS7000000	
SPRINKLER FITTINGS		
1/2" X 4" RISER EXTENSION FPT X MPT	44-RECO1/240	
3/4" X 4" RISER EXTENSION FPT X MPT	44-RECO3/440	
1" INSERT POLY X SWING/FUNNY PIPE ADAPTER	44-100SW0000	
1" VALVE MANIFOLD TEE S X S	44-HMT100G00	

TITAN INDUSTRIES, INC.
a world of products for the world of water

*Prices are subject to change without notice.
Returns are subject to a restock fee.
Special Orders are non-returnable.*

SPRINKLERS & ACCESSORIES

DESCRIPTION	PART No.	List Price
SPRINKLER FITTINGS CONT.		
3/4" POLY-STRETCH COUPLER	44-PSC070000	
1" POLY-STRETCH COUPLER	44-PSC100000	
1-1/4" POLY-STRETCH COUPLER	44-PSC120000	
1-1/2" POLY-STRETCH COUPLER	44-PSC150000	
SPRINKLER DRAINS		
1/2" MPT THREADED DRAIN	44-HP2000000	
3/4" MPT THREADED DRAIN	44-HP3000000	
1/2" MPT MAIN DRAIN	44-HP4000000	
SPRIKLER ELECTRIC ACCESSORIES		
3M INSULATION DISPLACEMENT CONNECTOR #22-#16 AWG	44-SSP316000	
SNAPLOCK GEL-FILLED SMALL WIRE CONNECTOR	44-LV9000000	
KING BLUE WIRE NUTS	44-KNGBLUNTS	
1HP-115V, 2HP-230V 24V PUMP START RELAY	44-PSR123240	
2HP-115V, 5HP-230V 24V PUMP START RELAY	44-PSR575240	
SPRINKLER TOOLS AND CUTTERS		
1/2" FIPT OUTLET CORING TOOL	44-HC4500000	
3/4" FIPT OUTLET CORING TOOL	44-HC5500000	
STUB WRENCH/NIPPLE EXTRACTOR TOOL	44-SW500C000	
9/16" NUT DRIVER	44-ND3750000	
DAWN SS YELLOW KWIK CUTTER FOR MEDIUM PIPE	57-KYT135SS0	
DAWN SS KWIK CUTTER FOR LARGEST PIPE	57-KSS200000	
DAWN SS KWIK CUTTER BLADE	57-KSSB20000	
DAWN SS KWIK CUTTER BLADE FOR SMALL PIPE	57-KBT100SS0	
DAWN SS KWIK CUTTER BLADE FOR MEDIUM PIPE	57-KBT135SS0	
36" CABLE SAW W/LOOP HANDLE	57-KCS36L000	
SPRINKLER MARKERS		
BLUE FLAG 4" X 5" W/21" WIRE STAFF	57-451WBLUE0	
GREEN FLAG 4" X 5" W/21" WIRE STAFF	57-451WGREEN	
FLUORESCENT LIME FLAG 4" X 5" W/21" WIRE STAFF	57-451WFLIME	
FLUORESCENT ORANGE FLAG 4" X 5" W/21" WIRE STAFF	57-451WFORAN	
FLUORESCENT PINK FLAG 4" X 5" W/21" WIRE STAFF	57-451WFPIK	
RED FLAG 4" X 5" W/21" WIRE STAFF	57-451WRED00	
WHITE FLAG 4" X 5" W/21" WIRE STAFF	57-451WWHITE	
VALVE BOXES		
6" ROUND VALVE BOX WITH COVER	44-107BCH000	
10" ROUND VALVE BOX WITH COVER	44-111BC0000	
10" X 15" RECTANGULAR VALVE BOX W/COVER	44-D100SG000	
12" X 17" STD RECTANGULAR VALVE BOX W/COVER	44-113BC0000	
12" X 20" JUMBO RECTANGULAR VALVE BOX W/COVER	44-117BC0000	
CARSON VALVE BOXES		
6" ROUND VALVE BOX WITH COVER	44-708940000	
6" ROUND VALVE BOX COVER ONLY	44-708400000	
10" ROUND VALVE BOX WITH COVER	44-910104000	
10" ROUND VALVE BOX COVER ONLY	44-910400000	
12" X 17" STANDARD RECTANGULAR VALVE BOX WITH COVER	44-141912000	

Prices are subject to change without notice.

Returns are subject to a restock fee.

Special Orders are non-returnable.

TITAN INDUSTRIES, INC.

a world of products for the world of water

SPRINKLERS & ACCESSORIES

DESCRIPTION	PART No.	List Price
CARSON VALVE BOXES CONT.		
12" X 17" STANDARD RECTANGULAR VALVE BOX 6" EXTENSION	44-14196X000	
12" X 17" STANDARD RECTANGULAR VALVE BOX COVER ONLY	44-141940000	
15" X 21" JUMBO RECTANGULAR VALVE BOX WITH COVER	44-122012000	
15" X 21" JUMBO RECTANGULAR VALVE BOX 6" EXTENSION	44-12206X000	
15" X 21" JUMBO RECTANGULAR VALVE BOX COVER ONLY	44-122040000	
PLASTIC WELL SEALS		
4X1X1-1/4 PLASTIC WELL SEAL	47-WSP041012	
5XBLANK PLASTIC WELL SEAL	47-WSP050000	
6XBLANK PLASTIC WELL SEAL	47-WSP060000	
6X1-1/2 PLASTIC WELL SEAL	47-WSP060015	

TITAN INDUSTRIES, INC.
a world of products for the world of water

*Prices are subject to change without notice.
 Returns are subject to a restock fee.
 Special Orders are non-returnable.*

DRIP TUBING & SPRINKLER ACCESSORIES

Item	Size	Part No.	List Price	Item	Size	Part No.	List Price
DRIP TUBING ROLLS	1/2" X 500'	37-SDT050500		DRIP LINE HOLE PUNCH		37-SPRHOLPUN	
	1/2" X 1000'	37-SDT051000					
	3/4" X 500'	37-SDT070500		EMITTERS 1 GPH	TLA	37-SPRTLAEMT	
	3/4" X 1000'	37-SDT071000			ISO FLO	37-SPRISOFLE	
	1" X 500'	37-SDT100500			SUPER FLO	37-SPRSUFLEM	
DRIP LINE COUPLER	1/2"	37-SPRCPL005		DRIP LINE FILTER	3/4" 13 GPM	37-SPRFILT07	
	3/4"	37-SPRCPL007					
	1"	37-SPRCPL010		PRESSURE REGULATOR	15 PSI	37-SPRPRSRG1	
DRIP LINE END PLUG	1/2"	37-SPREND005			30 PSI	37-SPRPRSRG3	
	3/4"	37-SPREND007		PRESSURE BREAKER ASSEMBLY	765-1" BV	37-SPRPREBRE	
	1"	37-SPREND010					
DRIP LINE 90°	1/2"	37-SPRELB005		BACKFLOW PREVENTER	1"	37-SPRBCKFVA	
	3/4"	37-SPRELB007					
	1"	37-SPRELB010		PRESSURE VACUUM BREAKER	2"	37-SPRBKVL20	
DRIP LINE TEE	1/2"	37-SPRTEE005		SUNFLOWER RICHEL VALVE	1" 150 PSI	37-SPRSFV010	
	3/4"	37-SPRTEE007					
	1"	37-SPRTEE010		SOLENOID VALVE 24 VOLT	1" 2400T	37-SPRSOLVL1	
INSERT COUPLER	1/2"	37-SPRICOP05			2"	37-SPRSOLEVL	
	3/4"	37-SPRICOP07		RAIN DIAL INDOOR CONTROL	6 STATION	37-SPRRD6000	
	1"	37-SPRICOP10					
INSERT X MALE PLASTIC ADAPTER	1/4"	37-SPRINML02		RAIN DIAL OUTDOOR CONTROL	9 STATION	37-SPRRD9000	
	1/2"	37-SPRINML05			9 STATION	37-SPRRD9000	
	3/4"	37-SPRINML07		RAT GUARD		37-RATGUD080	
	1"	37-SPRINML10					
MALE HOSE ADAPTER TUBE X INS.	1/2"	37-SPRHOSADM					
FEMALE HOSE ADAPTER TUBEX INS.	1/2"	37-SPRHOSADF					
DRIP TUBE ADAPTER FIPT X GARDEN HOSE		37-SPRADAPTR					
MALE/FEMALE QUICK CONNECT	3/4"	37-SPRMFCONN					
FHT X MHT BALL VALVE	3/4"	37-SPRBV07FM					
PLASTIC HEX BUSHING	1/2" X 1/4"	37-SPRHX0502					

TITAN INDUSTRIES, INC.
a world of products for the world of water

Prices are subject to change without notice.
 Returns are subject to a restock fee.
 Special Orders are non-returnable.

NOTES

CALL US TODAY!

PO Box 308
East Hwy 30
Paxton, Nebraska 69155
800-658-4086
308-239-4281
308-239-4474 (fax)

11555 S. Highway 283
Dodge City, Kansas 67801
800-658-4078
620-225-6201
620-225-1171 (fax)

1203 S.E. Grand Blvd.
Oklahoma, City, Oklahoma 73129
800-749-8659
405-677-1290
405-677-1296 (fax)

112 Grant - Aurora Industrial Park
Aurora, Nebraska 68818
800-255-4188
402-694-4188
402-694-4511 (fax)

1912 West Harry
Wichita, Kansas 67213
866-323-9111
316-262-9111
316-262-9119 (fax)

TITAN INDUSTRIES, INC.
a world of products for the world of water

PLUMBING PRODUCTS

Item	Size	Part No.	List Price	Item	Size	Part No.	List Price
THRIFT DRAIN CLEANER	1# 2# 6#	39-THRIFT001 39-THRIFT002 39-THRIFT006		32 OZ CLEAR CUTTING OIL		39-CUTOIL32Z	
WHAM DRAIN CLEANER	32OZ	39-WHAM20110		PRINSCO JOINT TAPE		39-JOINTTAPE	
RECTORSEAL				RIVETS	1/4"	39-RIVET0020	
PINT 5		39-RECTRS5PT		HOLDRITE PIPE SUPPORTS			
QUART 5		39-RECTRS5QT		50 IN POLYBAG		39-BRACKPIPE	
1/2 PINT T PLUS 2		39-RECTRTPHP		DWV J-HOOK			
PINT T-PLUS 2		39-RECTRTPQT		1/2" X 7" (25 IN POLYBAG)		39-JHOK05X70	
QUART T PLUS 2		39-RECTRTPQT		2" X 7" (25 IN POLYBAG)		39-JHOK20X70	
PIPE DOPE W/TEFLON				3" X 7" (25 IN POLYBAG)		39-JHOK30X70	
8OZ REAL TUFF TEFLON PASTE		39-RTFF15620		4" X 7" (25 IN POLYBAG)		39-JHOK40X70	
8 OZ		39-PIPDOP08Z		HANGER STRAP			
16 OZ		39-PIPDOP16Z		3/4"X10" 28 GA GALV		39-HANSTR071	
PIPE JOINT COMPOUND PINT		39-PIPEJOIN		3/4" X 50" PLASTIC		39-HANSTR075	
TEFLON TAPE				FULL PIPE CLAMP			
PINK TFE TEFLON TAPE		39-TEFLONTAP		1/2" W/BARBED NAIL		39-FLPIPCL05	
3/4"X 260" TEFLON TAPE		39-TEFLONTP7		3/4" W/BARBED NAIL		39-FLPIPCL07	
1/2" X 520" THREAD SEAL		39-TEFLTHR05		HALF PIPE CLAMP			
1/2" TAPE PACK		39-TEFLONTP5		1/2" W/BARBED NAIL		39-HFPIPCL05	
SILICONE CAULK				3/4" W/BARBED NAIL		39-HFPIPCL07	
10.3 OZ CARTRIDGE-WHITE		39-SILCAU10Z		1" W/BARBED NAIL		39-HFPIPCL10	
CAULK				COPPER TUBE STRAP			
6 OZ TUB-N-TILE CAULK		39-TUBTILCAU		1/2"		39-CUTUSTR05	
SEALANTS				OMEGA CLAMP	1-1/2"	39-CLAOME105	
6 OZ TUB-N-TILE SEALANT		39-TUBTILSEA		FLEX FLASH	1-1/4" - 1-1/5"	39-FLEXFL102	
THREAD SEALANTS					2"	39-FLESFL200	
16OZ MEGALOC		39-MEGA15808			3"	39-FLEXFL300	
4OZ PRO-POXY 20		39-POXY25515			4"	39-FLEXFL400	
PLUMBER'S PUTTY				ALUMINUM NO-CALK ROOF FLASHING	1-1/4" - 1-1/2"	16-FLSH12920	
14 OZ		39-PUTT31166			2"	16-FLSH12933	
3LB TUB		39-PLUMPUT3#			3"	16-FLSH12946	
5LB TUB		39-PUTT31174			4"	16-FLSH12959	
LUBRICANT				STUD GUARDS			
32 OZ FOR RUBBER GASKETS		39-LUBGASK32		1-1/2" X 3" 16 GA SELF-NAILING		39-STUGU1053	
ALCONOX	4# ALCONOX	39-4LBALCONX		PEX SINK SUPPLY RISER	12" 20" 30" 36"	16-RISS34310 16-RISS34312 16-RISS34313 16-RISS34314	
16 OZ HAND CLEANER		39-HANDCLE16		PEX TOILET SUPPLY RISER	12" 20"	16-RIST34315 16-RIST34317	
HERCULES FOR HANDS TOWEL		39-TWLS45333					

Titan Industries, Inc.
a world of products for the world of water

Prices are subject to change without notice.
Returns are subject to a restock fee.
Special Orders are non-returnable.

PLUMBING PRODUCTS

Item	Size	Part No.	List Price	Item	Size	Part No.	List Price
ABS IN-LINE VENT				SOLDER			
		39-ABSINLVEN		1LB SILVER LEAD FREE		39-SOLD1#SIL	
PVC CLOSET FLANGE				ABRASIVE SANDCLOTH			
3" OR 4" W/TESTCAP		39-CLSTFLNPV		1-1/2" X 10 YDS 120 GRIT		39-SSNDCLT15	
4" PVC TWIST-N-SET		39-FLNG43651		1-1/2"X5YDS 180 OPEN MESH		39-MESHCLT15	
4" REPLACEMENT W/SCREWS		39-FLNG43539		BRUSH			
BRASS CLOSET FLANGE				1/2" ACID BRUSHES		39-BRSH30711	
1-1/8" DEEP 200Z		16-961321000		1/2" ID FITTING BRUSH-CARDED		39-IDFITBR05	
CAST IRON FLANGE				3/4" ID FITTING BRUSH		39-IDFITBR07	
4" REPLACEMENT		39-FLNCIREPL		1" ID FITTING BRUSH		39-IDFITBR10	
4" TWIST-N-SET		39-FLNCITWIS		CHERNE TEST BALL PLUG			
TOILET BOLTS		39-TOILBOLTS					
BOWL RING W/SLEEVE							
URETHANE REINFORCED WAX		39-WAXBWRNSL					
TOILET WAX RINGS							
URINAL RING		39-WXR311870					
JOHNI-RING GASKET		39-WAXR90210		ECONO-GRIP PLUG		1-1/2"	57-JPLUG15EC
JOHNI-RING W/HORN		39-WAXR90220				2"	57-JPLUG20EC
JUMBO JOHNI-RING W/HORN		39-WAXR90241				3"	57-JPLUG30EC
TOILET BOLTS						4"	57-JPLUG40CH
1/4X2-1/4 JOHNI-BOLTS		39-JBLT90104				6"	57-JPLUG60CH
5/16X2-1/4 JOHNI-BOLTS		39-JBLT90124		EXTENTION INFLATION HOSE			
GENERAL PURPOSE DRAIN							
2" OR 3" PVC		39-GENPURDRA					
SHOWER BASE DRAIN							
2" NO-CAULK		39-NOCLKSHWD		CLOG BUSTER DRAIN FLUSHER		1-1/2" - 3"	16-CLG303135
CONE FOR LAVATORY SUPPLY						4" - 6"	16-CLG303143
3/8"		16-311500000		GAS LINE MANOMETER			
BRASS DROP EAR ELBOW							
1/2" SWT X FIP		16-441170000		GAS TEST GAUGE & BODY		3/4" 30#	57-TSG019698
BRASS SHOWER ARM LOCK						3/4" 100#	57-TSG019718
1/2"		16-912185000		ANTI-SIPHON FROST PROOF SILCOCK FIPT X MIPT			
CC X FIPT DIELECTRIC UNION							
1/2" X 3/4"		16-973112000					
3/4"		16-973111000					
1"		16-973116000		ANTI-SIPHON FROST PROOF SILCOCK SWEAT X MIPT		1/2"X3/4"X6"	48-H425BFP06
CC X MIP DIELECTRIC UNION						1/2"X3/4"X8"	48-H425BFP08
3/4"		16-973115000				1/2"X3/4"X10"	48-H425BFP10
TINNING FLUX						1/2"X3/4"X12"	48-H425BFP12
8 OZ WATER SOLUBLE		39-TINFLUX8Z		Prices are subject to change without notice.			
8OZ #5 PASTE FLUX		39-FLUX30014					

TITAN INDUSTRIES, INC.
a world of products for the world of water

*Prices are subject to change without notice.
Returns are subject to a restock fee.
Special Orders are non-returnable.*

PLUMBING PRODUCTS

Item	Size	Part No.	List Price	Item	Size	Part No.	List Price
COMPRESSION SUPPLY STOPS				2" WASHER BOX WITH 1/4 TURN VALVES			
1/2" IPS X 3/8" STRAIGHT		16-930501000		CENTER OUTLET MIP		16-BXW389340	
5/8" X 3/8" STRAIGHT		16-930505000		DUAL OUTLET SWT		16-BXW386730	
1/2" IPS X 3/8" ANGLE		16-930551000		DUAL OUTLET PEX		16-BXW386740	
5/8" X 3/8" ANGLE		16-930552000		DOUBLE OUTLET NO VALVE		39-WASOUT200	
COMPRESSION ICE MAKER VALVE				ICE MAKER BOX WITH 1/4 TURN VALVES			
5/8" X 1/4"		16-930566000		SWT		16-BXI386810	
BRASS COMPRESSION NEEDLE VALVE				PEX		16-BXI386840	
1/4"		48-BNV002000		ICE MAKER BOX NO VALVES		39-ICEOUTBOX	
3/8"		48-BNV003000					
WATER SUPPLY KIT							
		39-WATERSUPP					
MASTER FLUSH							
1/4" - 4"		39-MASTFLO24					
4" - 7"		39-MASTFL407					
5" - 9"		39-MASTFL509					

TITAN INDUSTRIES, INC.
a world of products for the world of water

*Prices are subject to change without notice.
 Returns are subject to a restock fee.
 Special Orders are non-returnable.*

COPPER TUBE & FITTINGS

Item	Size	Part No.	List Price	Item	Size	Part No.	List Price
TYPE K SOFT COPPER COILS	1/2" X 60'	17-C0TKSC050		COPPER REDUCING COUPLING C X C	1/2" X 1/4"	17-CFCR05020	
	1/2" X 100'	17-C0TKSC050			1/2" X 3/8"	17-CFCR05070	
	3/4" X 60'	17-C0TKSC070			3/4" X 1/2"	17-CFCR07050	
	3/4" X 100'	17-C0TKSC070			1" X 1/2"	17-CFCR10050	
	1" X 60'	17-C0TKSC100			1" X 3/4"	17-CFCR10070	
	1" X 100'	17-C0TKSC100			1-1/4" X 1/2"	17-CFCR12050	
					1-1/4" X 3/4"	17-CFCR12070	
TYPE L SOFT COPPER COILS	1/2" X 60'	17-C0TLSC050			1-1/4" X 1"	17-CFCR12100	
	1/2" X 100'	17-C0TLSC050			1-1/2" X 1/2"	17-CFCR15050	
	3/4" X 60'	17-C0TLSC070			1-1/2" X 3/4"	17-CFCR15070	
	3/4" X 100'	17-C0TLSC070			1-1/2" X 1"	17-CFCR15100	
	1" X 60'	17-C0TLSC100			1-1/2" X 1-1/4"	17-CFCR15120	
	1" X 100'	17-C0TLSC100			2" X 3/4"	17-CFCR20070	
					2" X 1"	17-CFCR20100	
TYPE L HARD COPPER 20' LENGTHS	1/2"	17-C0TL05000			2" X 1-1/4"	17-CFCR20120	
	3/4"	17-C0TL07000			2" X 1-1/2"	17-CFCR20150	
	1"	17-C0TL10000					
	1-1/4"	17-C0TL12000					
	1-1/2"	17-C0TL15000					
	2"	17-C0TL20000					
TYPE M HARD COPPER 20' LENGTHS	1/2"	17-C0TM05000					
	3/4"	17-C0TM07000					
	1"	17-C0TM10000					
	1-1/4"	17-C0TM12000					
	1-1/2"	17-C0TM15000					
	2"	17-C0TM20000					
REFRIG. COPPER TUBING	1/4" OD X 50'	17-C0TREF020					
	3/8" OD X 50'	17-C0TREF080					
COPPER C X C COUPLER	1/4"	17-CFC020000					
	1/2"	17-CFC050000					
	3/4"	17-CFC070000					
	1"	17-CFC100000					
	1-1/4"	17-CFC120000					
	1-1/2"	17-CFC150000					
	2"	17-CFC200000					
COPPER C X C COUPLING WITH OUT STOP	1/2"	17-CFCX05000					
	3/4"	17-CFCX07000					
	1"	17-CFCX10000					
	1-1/4"	17-CFCX12000					
	1-1/2"	17-CFCX15000					
	2"	17-CFCX20000					

COPPER PRICES SUBJECT TO CHANGE WITH MARKET

TITAN INDUSTRIES, INC.
a world of products for the world of water



*Prices are subject to change without notice.
Returns are subject to a restock fee.
Special Orders are non-returnable.*

COPPER TUBE & FITTINGS

Item	Size	Part No.	List Price	Item	Size	Part No.	List Price			
EAR DROP 90°	1/2"	17-CFD900500		COPPER FEMALE ADAPTER C X FIPT	1/2" X 1/4"	17-CFAFR0502				
	3/4"	17-CFD900700			1/2"	17-CFAF05000				
COPPER REDUCING 90° ELBOW C X C	3/4" X 1/2"	17-CFE9R0705		3/4"	17-CFAF07000					
	1" X 3/4"	17-CFE9R1007		1"	17-CFAF10000					
COPPER TEE C X C X C	1/4"	17-CFT020000		COPPER MALE ADAPTER C X MIPT	1/2"	17-CFAM05000				
	1/2"	17-CFT050000			3/4"	17-CFAM07000				
	3/4"	17-CFT070000			1"	17-CFAM10000				
	1"	17-CFT100000			1-1/4"	17-CFAM12000				
	1-1/4"	17-CFT120000			1-1/2"	17-CFAM15000				
	1-1/2"	17-CFT150000			2"	17-CFAM20000				
COPPER REDUCING TEE C X C X C	1/2" X 1/2" X 3/4"	17-CFTR05070		COPPER ADAPTER FTG X FIP	1/2"	17-CFFAF0500				
	3/4" X 1/2" X 1/2"	17-CFTR07050			3/4"	17-CFFAF0700				
	3/4" X 1/2" X 3/4"	17-CFTR07057			COPPER ADAPTER FTG X MIP	1/2"		17-CFFAM0500		
	3/4" X 3/4" X 1"	17-CFTR07071				3/4"		17-CFFAM0700		
	3/4" X 3/4" X 1/2"	17-CFTR07075				COPPER FITTING REDUCER FTG X C		1/2" X 1/4"	17-CFFR05020	
	1" X 1/2" X 1/2"	17-CFTR10050						1/2" X 3/8"	17-CFFR05070	
	1" X 1/2" X 1"	17-CFTR10051						3/4" X 1/2"	17-CFFR07050	
	1" X 1/2" X 3/4"	17-CFTR10057						1" X 1/2"	17-CFFR10050	
	1" X 3/4" X 3/4"	17-CFTR10070						1" X 3/4"	17-CFFR10070	
	1" X 3/4" X 1"	17-CFTR10071						1-1/4" X 1/2"	17-CFFR12050	
	1" X 3/4" X 1/2"	17-CFTR10075						1-1/4" X 3/4"	17-CFFR12070	
	1" X 1" X 1/2"	17-CFTR10105						1-1/4" X 1"	17-CFFR12100	
	1" X 1" X 3/4"	17-CFTR10107						1-1/2" X 1/2"	17-CFFR15050	
	1-1/4" X 1" X 1"	17-CFTR12101						1-1/2" X 3/4"	17-CFFR15070	
	1-1/4" X 1-1/4" X 1"	17-CFTR12121						1-1/2" X 1"	17-CFFR15100	
	1-1/4" X 1-1/4" X 1/2"	17-CFTR12125						1-1/2" X 1-1/4"	17-CFFR15120	
	1-1/4" X 1-1/4" X 3/4"	17-CFTR12127						2" X 1/2"	17-CFFR20050	
	1-1/2" X 1-1/2" X 1"	17-CFTR15151						2" X 3/4"	17-CFFR20070	
	1-1/2" X 1-1/2" X 1/2"	17-CFTR15155						2" X 1"	17-CFFR20100	
	1-1/2" X 1-1/2" X 3/4"	17-CFTR15157						2" X 1-1/4"	17-CFFR20120	
	2" X 2" X 1"	17-CFTR20201						2" X 1-1/2"	17-CFFR20150	
	2" X 2" X 1/2"	17-CFTR20205						FITTING BRUSH	1/2"	17-CFB050000
	2" X 2" X 3/4"	17-CFTR20207							3/4"	17-CFB070000
	2" X 2" X 1-1/4"	17-CFTR20212							1"	17-CFB100000
	2" X 2" X 1-1/2"	17-CFTR20215							ABRASIVE OPEN MESH 17-COPENMESH	
									ABRASIVE SAND CLOTH 17-CSANDCLOT	
									SILVER SOLDER 17-CSILVERSO	
COPPER UNION C X C	1/2"	17-CFUN05000		HANGER			1/2"	17-CFH050000		
	3/4"	17-CFUN07000					3/4"	17-CFH070000		
	1"	17-CFUN10000			COPPER PRICES SUBJECT TO CHANGE WITH MARKET					
	1-1/4"	17-CFUN12000			<i>Prices are subject to change without notice.</i>					
	1-1/2"	17-CFUN15000			<i>Returns are subject to a restock fee.</i>					
	2"	17-CFUN20000			<i>Special Orders are non-returnable.</i>					
COPPER C X C TUBE CAP	1/2"	17-CFCP05000								
	3/4"	17-CFCP07000								
	1"	17-CFCP10000								
	1-1/4"	17-CFCP12000								
	1-1/2"	17-CFCP15000								
2"	17-CFCP20000									

TITAN INDUSTRIES, INC.
a world of products for the world of water

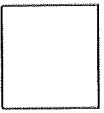
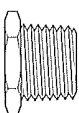
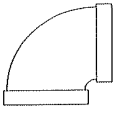
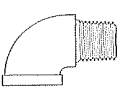
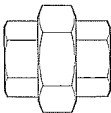
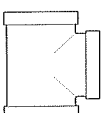
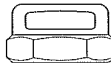
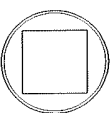
BRONZE FITTINGS

Item	Size	Part No.	List Price	Item	Size	Part No.	List Price	
	1/4"	14-10020ZCUP			1/4" X 1/8"	14-230201ZHX		
	3/8"	14-10030ZCUP			3/8" X 1/4"	14-230302ZHX		
	1/2"	14-10050ZCUP			1/2" X 1/4"	14-230502ZHX		
	3/4"	14-10070ZCUP			1/2" X 3/8"	14-230503ZHX		
	1"	14-10100ZCUP			3/4" X 1/4"	14-230702ZHX		
	1-1/4"	14-10120ZCUP			3/4" X 3/8"	14-230703ZHX		
	1-1/2"	14-10150ZCUP			3/4" X 1/2"	14-230705ZHX		
	2"	14-10200ZCUP			1" X 1/4"	14-231002ZHX		
	1/4"	14-1102090ZE			1" X 1/2"	14-231005ZHX		
	3/8"	14-1103090ZE			1" X 3/4"	14-231007ZHX		
	1/2"	14-1105090ZE			1-1/4" X 1/4"	14-231202ZHX		
	3/4"	14-1107090ZE			1-1/4" X 1/2"	14-231205ZHX		
	1"	14-1110090ZE			1-1/4" X 3/4"	14-231207ZHX		
	1-1/4"	14-1112090ZE			1-1/4" X 1"	14-231210ZHX		
	1-1/2"	14-1115090ZE			1-1/2" X 1"	14-231510ZHX		
2"	14-1120090ZE		1-1/2" X 1-1/4"	14-231512ZHX				
	1/8"	14-1301090ZS			1/2"	14-19050ZUNI		
	1/4"	14-1302090ZS			3/4"	14-19070ZUNI		
	3/8"	14-1303090ZS			1"	14-19100ZUNI		
	1/2"	14-1305090ZS			1-1/4"	14-19120ZUNI		
	3/4"	14-1307090ZS			1-1/2"	14-19150ZUNI		
	1"	14-1310090ZS			2"	14-19200ZUNI		
	1-1/4"	14-1312090ZS						
	1/4"	14-15020ZTEE				1/2"	14-20050ZCAP	
	3/8"	14-15030ZTEE				3/4"	14-20070ZCAP	
	1/2"	14-15050ZTEE						
	3/4"	14-15070ZTEE						
	1"	14-15100ZTEE						
	1-1/4"	14-15120ZTEE						
	1/8"	14-22010ZPLG				1/4" X CL	14-250200SNP	
	1/4"	14-22020ZPLG				1/4" X 1-1/2"	14-250215SNP	
	3/8"	14-22030ZPLG		1/4" X 2"		14-250220SNP		
	1/2"	14-22050ZPLG		1/4" X 2-1/2"		14-250225SNP		
	3/4"	14-22070ZPLG		1/4" X 3"		14-250230SNP		
	1"	14-22100ZPLG		1/4" X 3-1/2"		14-250235SNP		
	1-1/4"	14-22120ZPLG		1/4" X 4"		14-250240SNP		
	1-1/2"	14-22150ZPLG		1/4" X 5"		14-250250SNP		
2"	14-22200ZPLG		1/4" X 6"	14-250260SNP				
	3/4" X 1/2"	14-240705ZBL		3/8" X CL		14-250300SNP		
	1" X 3/4"	14-241007ZBL		3/8" X 2"		14-250320SNP		
	1-1/4" X 1"	14-241210ZBL		3/8" X 3"		14-250330SNP		
				1/2" X CL		14-250500SNP		
				1/2" X 1-1/2"		14-250515SNP		
				1/2" X 2"		14-250520SNP		
				1/2" X 2-1/2"	14-250525SNP			
				1/2" X 3"	14-250530SNP			
				1/2" X 3-1/2"	14-250535SNP			
				1/2" X 4"	14-250540SNP			
				1/2" X 4-1/2"	14-250545SNP			
				1/2" X 5"	14-250550SNP			
				1/2" X 5-1/2"	14-250555SNP			

TITAN INDUSTRIES, INC.
a world of products for the world of water

Prices are subject to change without notice.

Returns are subject to a restock fee.

Special Orders are non-returnable.

BRONZE FITTINGS

Item	Size	Part No.	List Price	Item	Size	Part No.	List Price
NIPPLE CONT. 	1/2" X 6"	14-250560SNP					
	3/4" X CL	14-250700SNP					
	3/4" X 1-1/2"	14-250715SNP					
	3/4" X 2"	14-250720SNP					
	3/4" X 2-1/2"	14-250725SNP					
	3/4" X 3"	14-250730SNP					
	3/4" X 3-1/2"	14-250735SNP					
	3/4" X 4"	14-250740SNP					
	3/4" X 4-1/2"	14-250745SNP					
	3/4" X 5"	14-250750SNP					
	3/4" X 5-1/2"	14-250755SNP					
	3/4" X 6"	14-250760SNP					
	1" X CL	14-251000SNP					
	1" X 2"	14-251020SNP					
	1" x 2-1/2"	14-251025SNP					
	1" X 3"	14-251030SNP					
	1" X 3-1/2"	14-251035SNP					
	1" X 4"	14-251040SNP					
	1" X 4-1/2"	14-251045SNP					
	1" X 5"	14-251050SNP					
	1" X 5-1/2"	14-251055SNP					
	1" X 6"	14-251060SNP					
	1-1/4" X CL	14-251200SNP					
	1-1/4" X 2"	14-251220SNP					
	1-1/4" X 2-1/2"	14-251225SNP					
	1-1/4" X 3"	14-251230SNP					
	1-1/4" X 3-1/2"	14-251235SNP					
	1-1/4" X 4"	14-251240SNP					
	1-1/4" X 4-1/2"	14-251245SNP					
	1-1/4" X 5"	14-251250SNP					
	1-1/4" X 5-1/2"	14-251255SNP					
	1-1/4" X 6"	14-251260SNP					
	1-1/2" X CL	14-251500SNP					
	1-1/2" X 2"	14-251520SNP					
	1-1/2" X 3"	14-251530SNP					
	1-1/2" X 4"	14-251540SNP					
	1-1/2" X 6"	14-251560SNP					
	2" X CL	14-252000SNP					
	2" X 2-1/2"	14-252025SNP					
	2" X 3"	14-252030SNP					
2" X 4"	14-252040SNP						
2" X 6"	14-252060SNP						

TITAN INDUSTRIES, INC.
a world of products for the world of water

*Prices are subject to change without notice.
Returns are subject to a restock fee.
Special Orders are non-returnable.*

BRASS COMPRESSION FITTINGS

Item	Size	Part No.	List Price	Item	Size	Part No.	List Price
BRASS FLARE X MPT 90° ELBOW	1/4" X 1/8"	14-1490201FL		BRASS COMPRESSION TEE	1/4"	14-18STE02CM	
	1/4" X 1/4"	14-1490202FL			3/8"	14-18STE03CM	
BRASS FLARE X MPT ADAPTER	1/4" X 1/8"	14-14M0201FL			5/8"	14-18STE06CM	
	1/4" X 1/4"	14-14M0202FL			7/8"	14-18STE08CM	
DELTRIN SLEEVE	1/4"	14-16DR02SLV		BRASS COMPRESSION REDUCING TEE	3/8" X 3/8" X 1/4"	14-18T0302CM	
	3/8"	14-16DR03SLV					
	5/8"	14-16DR06SLV		BRASS REDUCING COMPRESSION UNION	3/8" X 1/4"	14-18U0302CM	
			5/8" X 3/8"		14-18U0603CM		
BRASS INSERT	1/4"	14-16IN02SLV		BRASS COMPRESSION UNION ELBOW	1/4"	14-18UEL02CM	
	3/8"	14-16IN03SLV			3/8"	14-18UEL03CM	
BRASS COMPRESSION REDUCING ELBOW	5/8" X 3/8"	14-18E0602CM			5/8"	14-18UEL06CM	
					7/8"	14-18UEL08CM	
BRASS COMPRESSION FEMALE ADAPTER	1/4" X 1/2"	14-18F0205CM		BRASS COMPRESSION UNION	1/4"	14-18UNI02CM	
	3/8" X 1/2"	14-18F0305CM			3/8"	14-18UNI03CM	
	5/8" X 1/2"	14-18F0605CM			5/8"	14-18UNI06CM	
	5/8" X 3/4"	14-18F0607CM			7/8"	14-18UNI08CM	
	7/8" X 1/2"	14-18F0805CM		COMPRESSION UNION LIGHT PATTERN	1/4"	14-BCMPUNL02	
	7/8" X 3/4"	14-18F0807CM					
BRASS COMPRESSION MALE ADAPTER	1/4" X 1/8"	14-18M0201CM					
	1/4" X 1/4"	14-18M0202CM					
	1/4" X 1/2"	14-18M0205CM					
	3/8" X 1/2"	14-18M0305CM					
	5/8" X 1/2"	14-18M0605CM					
	5/8" X 3/4"	14-18M0607CM					
	7/8" X 3/4"	14-18M0807CM					
BRASS COMPRESSION MALE ELBOW	3/8" X 3/8"	14-18MEL03CM					
BRASS COMPRESSION NUT	1/4"	14-18NT020CM					
	3/8"	14-18NT030CM					
CHROME PLATED COMPRESSION NUT	3/8"	14-18NTC03CM					
BRASS COMPRESSION SLEEVE	1/4"	14-18SLV02CM					
	3/8"	14-18SLV03CM					

Prices are subject to change without notice.

Returns are subject to a restock fee.

Special Orders are non-returnable.

TITAN INDUSTRIES, INC.
a world of products for the world of water

RED & YELLOW BRASS FITTINGS

Item	Size	Part No.	List Price	Item	Size	Part No.	List Price
YELLOW BRASS MALE ADAPTER (PLASTIC TO MIP)	1/2"	14-IBMA05000		RED BRASS INSERT TEE	3/4"	14-RBDT07500	
	3/4"	14-IBMA07500			1"	14-RBDT10000	
	1"	14-IBMA10000			1-1/4"	14-RBDT12500	
	1-1/4"	14-IBMA12500		RED BRASS 90° INSERT ELBOW	3/4"	14-RBDE75000	
	1-1/2"	14-IBMA15000			1"	14-RBDE10000	
2"	14-IBMA20000		1-1/4"	14-RBDE12500			
YELLOW BRASS INSERT COUPLER	3/4"	14-IBCP07500		90° STREET ELBOW	1/8"	14-RBE001000	
	1"	14-IBCP10000		3/4"	14-RBE007000		
	1-1/4"	14-IBCP12500		90° ELBOW	3/4" HYDRANT	14-BE0790000	
	1-1/2"	14-IBCP15000			1" FIP	14-BE1090000	
2"	14-IBCP20000		2" YELLOW	14-BEM500000			
YELLOW BRASS INSERT X MALE SWEAT ADAPTER	3/4"	14-IBSA75000		BRASS DROP PIPE COUPLER	1"	14-BC1000000	
	1"	14-IBSA10000			1-1/4"	14-BC1250000	
	1-1/4"	14-IBSA125000			1-1/2"	14-BC1500000	
			2"		14-BC2000000		
RED BRASS MALE INSERT ADAPTER (PLASTIC TO MIP W/HEX)	1/2"	14-RBMA05000		GARDEN HOSE FITTINGS			
	3/4"	14-RBMA07500		3/4" X 1/2" BRASS GARDEN HOSE RIGID (MGH X MPT)	14-21MR0705G		
	1"	14-RBMA10000		3/4" X 3/8" BRASS GARDEN HOSE RIGID (MGH X MPT)	14-BMGH07080		
	1" X 3/4"	14-RBMA10750		3/4" X 3/4" X 1/2" BRASS GARDEN HOSE RIGID (MGH X MPT)	14-21MR0707G		
	1" X 1-1/4"	14-RBMA10250		3/4" BRASS RIGID GARDEN HOSE (MGH X MGH)	14-21MR07GAR		
	1-1/4"	14-RBMA12500		3/4" X 3/4" BRASS GARDEN HOSE RIGID (MGH X FPT)	14-21MS0707G		
1-1/4" X 1"	14-RBMA25100		3/4" BRASS GARDEN HOSE PLUG	14-21PLG07GR			
1-1/2"	14-RBMA15000		RED GARDEN HOSE WASHERS	14-21REDWSHG			
2"	14-RBMA20000		3/4" X 1/2" BRASS GARDEN HOSE SWIVEL (FGH X FPT)	14-21SF0705G			
RED BRASS FEMALE INSERT ADAPTER (PLASTIC TO FIP W/HEX)	3/4"	14-RBFA07500		3/4" X 3/4" BRASS GARDEN HOSE SWIVEL (FGH X FPT)	14-21SF0707G		
	1"	14-RBFA10000		3/4" X 3/4" BRASS GARDEN HOSE SWIVEL	14-21SWV07GR		
	1-1/4"	14-RBFA12500		3/4" X 3/4" X 3/4" BRASS GARDEN HOSE "Y" CONNECTOR	14-21Y0707GR		
	1-1/2"	14-RBFA15000		BRASS GARDEN HOSE CAP	14-BGHCAP000		
	2"	14-RBFA20000		1/4" RIGID MALE ADAPTER HOSE ID X MALE PIPE	14-BMHB02000		
RED BRASS COUPLING (PLASTIC TO PLASTIC W/HEX)	3/4"	14-RBCP07500		1/4" X 1/8" RIGID MALE ADAPTER HOSE ID X MALE	14-BMHB02010		
	3/4" X 1"	14-RBCP07510					
	1"	14-RBCP10000					
	1" X 1-1/4"	14-RBCP10250					
	1-1/4"	14-RBCP12500					
	1-1/2"	14-RBCP15000					
2"	14-RBCP20000						
2" EXTRA LONG	14-RBCP200XL						
REDUCING COUPLER	3/4" X 1/2"	14-RBRCP0705					
	1" X 3/4"	14-RBRCP1007					

TITAN INDUSTRIES, INC.
a world of products for the world of water

*Prices are subject to change without notice.
Returns are subject to a restock fee.
Special Orders are non-returnable.*

SCHEDULE 40 CPVC

Item	Size	Part No.	List Price	Item	Size	Part No.	List Price
CTS SLIP TEE	1/2"	30-410100500					
	3/4"	30-410100700					
	1"	30-410101000					
	2"	30-410102000					
REDUCING CTS SLIP TEE	3/4" X 3/4" X 1/2"	30-410110100					
CTS 90° SLIP ELBOW	1/2"	30-410600500					
	3/4"	30-410600700					
	1"	30-410601000					
CTS 90° SP X SLIP ELBOW	1/2"	30-410900500					
	3/4"	30-410900700					
CTS 45° SLIP ELBOW	1/2"	30-411700500					
	3/4"	30-411700700					
	1"	30-411701000					
CTS SLIP COUPLER	1/2"	30-412900500					
	3/4"	30-412900700					
	1"	30-412901000					
	2"	30-412902000					
CTS REDUCING SLIP COUPLER	3/4" X 1/2"	30-412910100					
CTS FEMALE ADAPTER	1/2"	30-413500500					
	3/4"	30-413500700					
	1"	30-413501000					
CST SS FEMALE ADAPTER	1/2"	30-4135005SR					
	3/4"	30-4135007SR					
CTS MALE ADAPTER	1/2"	30-413600500					
	3/4"	30-413600700					
	1"	30-413601000					
CTS REDUCER BUSHING	3/4" X 1/2" (SPIG X SLIP)	30-413710100					
TRANSITION COUPLER	3/4" IPS X CTS	30-414100700					
CTS SLIP CAP	1/2"	30-414700500					
	3/4"	30-414700700					
CTS SLIP BALL VALVE	1/2"	28-192200500					
	3/4"	28-192200700					

TITAN INDUSTRIES, INC.
a world of products for the world of water

Prices are subject to change without notice.

Returns are subject to a restock fee.

Special Orders are non-returnable.

SCHEDULE 80 CPVC

Item	Size	Part No.	List Price	Item	Size	Part No.	List Price
SLIP TEE SCH 80	1/2"	30-801005C00		MALE ADAPTER SCH 80	1/2"	30-836005C00	
	3/4"	30-801007C00			3/4"	30-836007C00	
	1"	30-801010C00			1"	30-836010C00	
	1-1/4"	30-801012C00			1-1/4"	30-836012C00	
	1-1/2"	30-801015C00			1-1/2"	30-836015C00	
	2"	30-801020C00			2"	30-836020C00	
	2-1/2"	30-801025C00			2-1/2"	30-836025C00	
	3"	30-801030C00			3"	30-836030C00	
4"	30-801040C00		4"	30-836040C00			
90° SLIP ELBOW SCH 80	1/2"	30-806005C00		REDUCER BUSHING SCH 80	1/2" X 3/8"	30-837073C00	
	3/4"	30-806007C00			3/4" X 1/2"	30-837101C00	
	1"	30-806010C00			1" X 1/2"	30-837130C00	
	1-1/4"	30-806012C00			1" X 3/4"	30-837131C00	
	1-1/2"	30-806015C00			2" X 1-1/2"	30-837251C00	
	2"	30-806020C00			1"X1/2"SPIGXFIPT	30-838130C00	
45° ELBOW (SOC) SCH 80	1/4"	30-817002C00		CAP (SOC) SCH 80	1/2"	30-847005C00	
	3/8"	30-817003C00			3/4"	30-847007C00	
	1/2"	30-817005C00			1"	30-847010C00	
	3/4"	30-817007C00			1-1/4"	30-847012C00	
	1"	30-817010C00			2"	30-847020C00	
	1-1/4"	30-817012C00			1-1/4" (FIPT)	30-848012C00	
	1-1/2"	30-817015C00					
	2"	30-817020C00					
4"	30-817040C00						
45° ELBOW (FIPTXFIPT) SCH 80	1/2"	30-819005C00		SLIP UNION W/VITON O-RING SEAL	1-1/2"	30-8057015C0	
	3/4"	30-819007C00			OLD STYLE 1-1/2"	30-857015C00	
	1"	30-819010C00					
	1-1/4"	30-819012C00					
	1-1/2"	30-819015C00					
	2"	30-819020C00					
4"	30-819040C00						
COUPLER (SOC) SCH 80	1/2"	30-829005C00		ADAPTER	2" MALEXSP	30-861020C00	
	3/4"	30-829007C00					
	1"	30-829010C00					
	1-1/4"	30-829012C00					
	1-1/2"	30-829015C00					
	2"	30-829020C00					
	2-1/2"	30-829025C00					
	10"	30-829100CF0					
FEMALE ADAPTER SCH 80	1/4"	30-835002C00					
	3/8"	30-835003C00					
	1/2"	30-835005C00					
	3/4"	30-835007C00					
	1"	30-835010C00					
	1-1/4"	30-835012C00					
	1-1/2"	30-835015C00					
	2"	30-835020C00					
	2-1/2"	30-835025C00					
	3"	30-835030C00					
4"	30-835040C00						

TITAN INDUSTRIES, INC.
a world of products for the world of water

*Prices are subject to change without notice.
Returns are subject to a restock fee.
Special Orders are non-returnable.*

KITEC K1 CONNECTORS

Item	Size	List Price
K1 ADAPTERS		
KITEC X MALE TREAD ADAPTER	3/8" K1 X 3/8" MPT	16-088078000
	3/8" K1 X 1/2" MPT	16-088072000
	1/2" K1 X 1/2" MPT	16-088080000
	1/2" K1 X 3/4" MPT	16-088492000
	5/8" K1 X 1/2" MPT	16-088121000
	5/8" K1 X 3/4" MPT	16-088081000
	3/4" K1 X 3/4" MPT	16-088122000
	3/4" K1 X 1" MPT	16-088082000
1" K1 X 1" MPT	16-088120000	
KITEC X MALE THREAD ADAPTER 302 SS FITTING	1/2" K1 X M THREAD	16-088241000
	3/4" K1 X M THREAD	16-088242000
KITEC X FEMALE THREAD ADAPTER	3/8" K1 X 1/2" FPT	16-088073000
	1/2" K1 X 1/2" FPT	16-088085000
	1/2" K1 X 3/4" FPT	16-088066000
	5/8" K1 X 1/2" FPT	16-088123000
	5/8" K1 X 3/4" FPT	16-088086000
	3/4" K1 X 3/4" FPT	16-088124000
	3/4" K1 X 1" FPT	16-088087000
1" K1 X 1" FPT	16-088127000	
KITEC X COPPER SOLDER SPIGOT ADAPTER	3/8" K1 X 3/8" COPPER	16-088079000
	3/8" K1 X 1/2" COPPER	16-088075000
	1/2" K1 X 1/2" COPPER	16-088138000
	1/2" K1 X 1/2" COPPER NICKEL PLTD	16-088246000
	5/8" K1 X 3/4" COPPER	16-088139000
	3/4" K1 X 3/4" COPPER	16-088221000
1" K1 X 1" COPPER	16-088222000	
KITEC X COPPER SOLDER SOCKET ADAPTER	3/8" K1 X 1/2" CU	16-088074000
	1/2" K1 X 1/2" CU	16-088135000
	1/2" K1 X 3/4" CU	16-088149000
	5/8" K1 X 3/4" CU	16-088136000
	3/4" K1 X 1/2" CU	16-088153000
	3/4" K1 X 3/4" CU	16-088148000
	3/4" K1 X 1" CU	16-088220000
1" K1 X 1" CU	16-088245000	
KITEC X COPPER COMPRESSION ADAPTER	3/8" K1 X 3/8" (1/2" OD) STRT	16-088077000
	1/2" KITEC X 1/4" (3/8" OD) CU STRAIGHT	16-088244000
	1/2" K1 X 1/4" (3/8" OD) CU ANGLE	16-088243000
	1/2" K1 X 1/4" (3/8" OD) CU STRAIGHT PLTD	16-088244000
	1/2" K1 X 1/4" (3/8" OD) CU ANGLE PLTD	16-088248000
	1/2" K1 X 1/2" (5/8" OD) CU	16-088258000
5/8" K1 X 3/4" (7/8" OD) CU	16-088257000	
3/4" K1 X 3/4" (7/8" OD) CU	16-088259000	
K1 ELBOWS		
KITEC X KITEC 90° ELBOW	1/2" K1 X K1	16-088095000
	5/8" K1 X K1	16-088096000
	3/4" K1 X K1	16-088097000
	1" K1 X K1	16-088098000

TITAN INDUSTRIES, INC.
a world of products for the world of water

*Prices are subject to change without notice.
Returns are subject to a restock fee.
Special Orders are non-returnable.*

KITEC K1 CONNECTORS

Item	Size	List Price
K1 ELBOWS CONT.		
KITEC X FEMALE THREAD 90° ELBOW	1/2" K1 X 1/2" FPT	16-088100000
	5/8" K1 X 3/4" FPT	16-088102000
	3/4" K1 X 1" FPT	16-088103000
KITEC X MALE THREAD 90° ELBOW	1/2" K1 X 3/8" MPT	16-088745000
	1/2" K1 X 1/2" MPT	16-088465000
	3/4" K1 X 3/4" MPT	16-088068000
KITEC X COPPER SOCKET THREAD 90° ELBOW	1/2" K1 X 1/2" CU SOCKET	16-088213000
	1/2" K1 X 3/4" CU SOCKET	16-088156000
	5/8" K1 X 3/4" CU SOCKET	16-088155000
	3/4" K1 X 3/4" CU SOCKET	16-088067000
KITEC X COPPER SPIGOT THREAD 90° ELBOW	1/2" K1 X 1/2" CU SPIGOT	16-088218000
	1/2" K1 X 3/4" CU SPIGOT	16-088150000
	5/8" K1 X 3/4" CU SPIGOT	16-088151000
	3/4" K1 X 3/4" CU SPIGOT	16-088157000
KITEC X FEMALE THREAD WING BACK (OR DROP- EAR) 90° ELBOW	1/2" K1 X 1/2" FPT DROP EAR	16-088209000
K1 TEES		
KITEC X KITEC X KITEC TEE	1/2" K1 X K1 X K1	16-088106000
	5/8" K1 X K1 X K1	16-088107000
	3/4" K1 X K1 X K1	16-088108000
	1" K1 X K1 X K1	16-088114000
KITEC X KITEC X KITEC REDUCING TEE	5/8" X 5/8" X 1/2" K1	16-088104000
	3/4" X 1/2" X 1/2" K1	16-088110000
	3/4" X 3/4" X 1/2" K1	16-088109000
	3/4" X 1/2" X 3/4" K1	16-088285000
	3/4" X 3/4" X 5/8" K1	16-088105000
	1" X 1/2" X 1/2" K1	16-088291000
	1" X 1" X 1/2" K1	16-088290000
	1" X 3/4" X 3/4" K1	16-088286000
	1" X 1" X 3/4" K1	16-088115000
KITEC X KITEC X FEMALE THREAD TEE	1/2" K1 X 1/2" K1 X 1/2" FPT	16-088111000
	5/8" K1 X 5/8" K1 X 3/4" FPT	16-088112000
	3/4" K1 X 3/4" K1 X 1" FPT	16-088113000
COPPER X COPPER X KITEC TEE	1/2" CU COMP X 1/2" CU COMP X 1/2" K1	16-088468000
PREFORMED COPPER ADAPTER		
STUB-OUT ELL	1/2" K1 SPUN CLOSED CU 3-1/2" X 20"	16-088174000
	1/2" K1 SPUN CLOSED CU 3-1/2" X 6"	16-088175000
	3/4" K1 SPUN CLOSED CU 4" X 8"	16-088175000
TUB VALVE SUPPLY	1/2" K1 X M SWEAT CU 4" X 3"	16-088177000
SWIVEL FAUCET	1/2" K1 X 1/2" FPT SWIVEL FAUCET CONNECTOR	16-088178000

TITAN INDUSTRIES, INC.
a world of products for the world of water

*Prices are subject to change without notice.
Returns are subject to a restock fee.
Special Orders are non-returnable.*

KITEC K1 CONNECTORS

Item	Size	List Price	
K1 COUPLINGS & CAPS			
KITEC X KITEC COUPLING	3/8" K1 X K1	16-088076000	
	1/2" K1 X K1	16-088090000	
	5/8" K1 X K1	16-088091000	
	3/4" K1 X K1	16-088092000	
	1" K1 X K1	16-088128000	
KITEC REDUCING COUPLING	5/8" X 1/2"	16-088125000	
	3/4" X 1/2"	16-088119000	
	3/4" X 5/8"	16-088126000	
	1" X 3/4"	16-088255000	
KITEC X CAP	1/2"	16-088116000	
	5/8"	16-088117000	
	3/4"	16-088118000	
	1"	16-088318000	
COPPER MANIFOLD 6' LONG X 24 OUTLETS SPIGOT	1" X 1/2"	16-088140000	
COPPER MANIFOLD 1" TRUNK C/W 3/4" COPPER PLAIN END SPUN CLOSED ONE END	3 OUTLETS C/W 3/8" KITEC ENDS	16-088802000	
	2 OUTLETS C/W 1/2" KITEC ENDS	16-088804000	
	12 OUTLETS C/W 1/2" KITEC ENDS	16-088327000	
	4 OUTLETS C/W DAHL VALVES, WITH 1/2" KITEC ENDS	16-088170000	
	5 OUTLETS C/W DAHL VALVES, WITH 1/2" KITEC ENDS	16-088179000	
K1 VALVES			
DAHL MINI BALL VALVE FOR KITEC	3/8" K1 X 1/2" CU SOCKET	16-088182000	
	1/2" K1 X 1/2" CU SOCKET	16-088141000	
	1/2" K1 X 1/2" MPT SOCKET	16-088142000	
	1/2" K1 X K1	16-088133000	
	1/2" K1 X 1/2" CU COMP	16-088132000	
	1/2" K1 X 1/2" CU SPIGOT	16-088830000	
	1/2" K1 X 1/4" CU COMP STRT PLTD	16-088145000	
	1/2" K1 X 1/4" (3/8" OD) CU COMP AGL PLTD	16-088146000	
	5/8" K1 X K1	16-088134000	
	5/8" K1 X 3/4" CU SOCKET	16-088143000	
	5/8" K1 X 3/4" MPT	16-088144000	
	COPPER BALANCING VALVE	1/2" K1 X 1/2" COPPER	16-088183000
		1/2" K1 X 1/2" MPT	16-088186000

TITAN INDUSTRIES, INC.
a world of products for the world of water

Prices are subject to change without notice.

Returns are subject to a restock fee.

Special Orders are non-returnable.

KITEC ACCESSORIES

Item	Size	List Price
ACCESSORIES		
BEVELLING TOOL	5 IN 1 BEVELLING TOOL	16-088347000
	FOR 3/8", 1/2", 5/8"	16-088320000
	FOR 1/2", 3/4", 1"	16-088321000
	FOR 1/2", 5/8", 3/4"	16-088130000
CUTTER		16-088210000
REPLACEMENT BLADE		16-088211000
PIPE HANGER	1/2" KITEC (3/8" IPS)	16-088300000
	5/8" (1/2" IPS)	16-088301000
	3/4" KITEC (3/4" IPS)	16-088302000
	1" KITEC (1" IPS)	16-088303000
HALF HANGER NAIL CLIP	1/2"	16-088304000
	3/4"	16-088306000
HEAT SHRINK REPAIR SLEEVE	4" FOR 3/8", 1/2", 5/8" FITTINGS	16-088323000
	4" FOR 3/4", 1" FITTINGS	16-088322000
PROTECTIVE SLEEVE	1/2", 5/8" KITEC	16-088206000
OUTSIDE BENDING SPRING	1/2"	16-088310000
	3/4"	16-088312000
REPLACEMENT PARTS		
BRASS SPLIT RING	1/2"	16-088203000
	5/8"	16-088204000
	3/4"	16-088205000
	1"	16-088180000
O-RING	3/8"	16-088216000
	1/2"	16-088200000
	5/8"	16-088201000
	3/4"	16-088202000
	1"	16-088199000

TITAN INDUSTRIES, INC.
a world of products for the world of water

*Prices are subject to change without notice.
Returns are subject to a restock fee.
Special Orders are non-returnable.*

KITEC K2 CONNECTORS

Item	Size	List Price
K2 ADAPTERS		
KITEC X MALE THREAD ADAPTER	1/2" K2 X 1/2" MPT	16-088525000
	1/2" K2 X 3/4" MPT	16-088595000
	5/8" K2 X 3/4" MPT	16-088526000
	3/4" K2 X 1/2" MPT	16-088596000
	3/4" K2 X 3/4" MPT	16-088516000
	3/4" K2 X 1" MPT	16-088517000
	1" K2 X 1" MPT	16-088518000
KITEC X FEMALE THREAD ADAPTER	1/2" K2 X 1/2" FPT	16-088519000
	1/2" K2 X 3/4" FPT	16-088597000
	5/8" K2 X 3/4" FPT	16-088527000
	3/4" K2 X 1/2" FPT	16-088598000
	3/4" K2 X 3/4" FPT	16-088520000
	3/4" K2 X 1" FPT	16-088521000
	1" K2 X 1" FPT	16-088522000
KITEC X COPPER SPIGOT ADAPTER	1/2" K2 X 1/2" COPPER	16-088530000
	1/2" K2 X 1/2" COPPER NICKEL PLTD	16-088523000
	5/8" K2 X 3/4" COPPER	16-088531000
	1/2" K2 X 3/4" COPPER	16-088559000
	3/4" K2 X 3/4" COPPER	16-088524000
	1" K2 X 1" COPPER	16-088560000
KITEC X COPPER SOCKET ADAPTER	1/2" K2 X 1/2" COPPER	16-088528000
	1/2" K2 X 3/4" COPPER	16-088564000
	5/8" K2 X 3/4" COPPER	16-088529000
	3/4" K2 X 1/2" COPPER	16-088599000
	3/4" K2 X 3/4" COPPER	16-088561000
	3/4" K2 X 1" COPPER	16-088562000
KITEC X COPPER SOCKET ADAPTER	1" K2 X 1" COPPER	16-088563000
	KITEC X COMPRESSION ADAPTER	
	1/2" K2 X 1/4" (3/8" OD) COPPER STRAIGHT	16-088532000
	1/2" K2 X 1/4" (3/8" OD) COPPER ANGLE	16-088580000
	1/2" K2 X 1/4" (3/8" OD) COPPER STRAIGHT PLTD	16-088585000
	1/2" K2 X 1/4" (3/8" OD) COPPER ANGLE PLTD	16-088586000
1/2" K2 X 1/2" COPPER STRAIGHT	16-088587000	
3/4" K2 X 3/4" COPPER STRAIGHT	16-088588000	
K2 ELBOWS		
KITEC X KITEC 90° ELBOW	1/2" K2 X K2	16-088535000
	5/8" K2 X K2	16-088536000
	3/4" K2 X K2 90°	16-088533000
	1" K2 X K2 90°	16-088534000
KITEC X MALE THREAD 90° ELBOW	1/2" K2 X 1/2" MPT	16-088590000
	1/2" K2 X 3/8" MPT	16-088592000
KITEC X COPPER SOCKET THREAD 90° ELBOW	1/2" K2 X 1/2" CU SOCKET	16-088537000
	1/2" K2 X 3/4" CU SOCKET	16-088589000
	5/8" K2 X 3/4" CU SOCKET	16-088538000
	3/4" K2 X 3/4" CU SOCKET	16-088539000

TITAN INDUSTRIES, INC.
a world of products for the world of water

*Prices are subject to change without notice.
Returns are subject to a restock fee.
Special Orders are non-returnable.*

KITEC K2 CONNECTORS

Item	Size	List Price
K2 ELBOWS CONT.		
KITEC X COPPER SPIGOT THREAD 90° ELBOW	1/2" K2 X 1/2" CU SPIGOT	16-088508000
KITEC X FEMALE THREAD WING BACK (OR DROP- EAR) 90° ELBOW	1/2" K2 X 1/2" FPT DROP EAR 3/4" K2 X 3/4" FPT DROP EAR	16-088543000 16-088544000
K2 TEES		
KITEC X KITEC X COPPER SOCKET TEE	1/2" K2 X 1/2" K2 X 1/2" CU 3/4" K2 X 3/4" K2 X 3/4" CU 1" K2 X 1" K2 X 1" CU	16-088579000 16-088644000 16-088646000
KITEC X KITEC X COPPER STUB-OUT (6")	1/2" K2 X 1/2" K2 X 1/2" CU 3/4" K2 X 3/4" K2 X 3/4" CU 1" K2 X 1" K2 X 1" CU	16-088662000 16-088663000 16-088664000
KITEC X KITEC X KITEC TEE	1/2" K2 X K2 X K2 5/8" K2 X K2 X K2 3/4" K2 X K2 X K2 1" K2 X K2 X K2	16-088510000 16-088511000 16-088565000 16-088569000
KITEC X KITEC X KITEC STRAIGHT REDUCING TEE	1/2" X 1/2" X 5/8" K2 1/2" X 1/2" X 3/4" K2 5/8" X 1/2" X 1/2" K2 5/8" X 1/2" X 5/8" K2 5/8" X 5/8" X 1/2" K2 3/4" X 1/2" X 1/2" K2 3/4" X 1/2" X 3/4" K2 3/4" X 3/4" X 1/2" K2 3/4" X 3/4" X 5/8" K2 3/4" X 3/4" X 1" K2 1" X 1/2" X 1/2" K2 1" X 1/2" X 3/4" K2 1" X 1/2" X 1" K2 1" X 3/4" X 1/2" K2 1" X 3/4" X 3/4" K2 1" X 3/4" X 1" K2 1" X 1" X 1/2" K2 1" X 1" X 3/4" K2	16-088512000 16-088572000 16-088513000 16-088514000 16-088515000 16-088566000 16-088571000 16-088567000 16-088568000 16-088573000 16-088593000 16-088581000 16-088582000 16-088583000 16-088574000 16-088499000 16-088576000 16-088570000
PREFORMED COPPER ADAPTER		
STUB-OUT	3/4" K2 SPUN CLOSED CU 4" X 8" ELL	16-088577000
SWIVEL CONNECTOR	1/2" K2 X 1/2" FPT SWIVEL 90° ELL 1/2" K2 X 1/2" FPT SWIVEL FAUCET CONN 1/2" K2 TOILET CONNECTOR	16-088591000 16-088540000 16-088541000
K2 COUPLINGS, CAPS		
KITEC X KITEC COUPLING	1/2" K2 X K2 5/8" K2 X K2 3/4" K2 X K2 1" K2 X K2	16-088500000 16-088501000 16-088503000 16-088504000

TITAN INDUSTRIES, INC.
a world of products for the world of water

*Prices are subject to change without notice.
Returns are subject to a restock fee.
Special Orders are non-returnable.*

KITEC K2 CONNECTORS

Item	Size	List Price
K2 COUPLINGS, CAPS CONT.		
KITEC REDUCING COUPLING	5/8" X 1/2" K2	16-088502000
	3/4" X 1/2" K2	16-088505000
	3/4" X 5/8" K2	16-088506000
	1" X 3/4" K2	16-088507000
KITEC X CAP (PLUG)	1/2" K2 X CAP	16-088545000
	5/8" K2 X CAP	16-088546000
	3/4" K2 X CAP	16-088547000
	1" K2 X CAP	16-088548000
PLASTIC TEST PLUG	1/2" K2 PLASTIC TEST PLUG	16-088378000
	3/4" K2 PLASTIC TEST PLUG	16-088379000
COPPER MANIFOLD 1" TRUNK C/W 3/4" K2 FITTING ONE END SPUN CLOSED ONE END	12 OUTLETS C/W 1/2" KITEC ENDS	16-088812000
COPPER MANIFOLD FLOW-THROUGH' 1" TRUNK C/W 3/4" K2 FITTING BOTH ENDS	3 OUTLETS C/W 1/2" KITEC ENDS	16-088820000
	6 OUTLETS C/W 1/2" KITEC ENDS	16-088823000
K2 VALVES		
DAHL MINI BALL VALVE FOR KITEC CRIMP ENDS	1/2" K2 X 1/4" OD FOR ICE MAKER	16-088619000
	1/2" K2 X 1/2" COPPER SOCKET	16-088620000
	1/2" K2 X 1/2" MPT	16-088621000
	1/2" K2 X 1/2" K2	16-088622000
	1/2" K2 X 1/2" COPPER COMP	16-088623000
	5/8" K2 X 5/8" K2	16-088626000
	5/8" K2 X 3/4" COPPER SOCKET	16-088627000
	5/8" K2 X 3/4" MPT	16-088628000
	3/4" K2 X 3/4" K2	16-088629000
	3/4" K2 X 3/4" COPPER SOCKET	16-088630000
KITEC X COPPER COMPRESSION ADAPTER	1/2" K2 X 1/4" (3/8 OD) COPPER COMP - STRT PLATED	16-088624000
	1/2" K2 X 1/4" (3/8 OD) COPPER COMP ANGLE PLATED	16-088625000
BALANCING VALVE	1/2" K2 X 1/2" COPPER SOCKET	16-088618000
	1/2" K2 X 1/2" MPT	16-088617000
CRIMP RING NICKEL PLATED SOFT COPPER	1/2" K2	16-088550000
	5/8" K2	16-088551000
	3/4" K2	16-088552000
	1" K2	16-088553000
CRIMP TOOL WITH GO-GAUGE	1/2" (15" LONG)	16-088554000
	1/2" (18" LONG)	16-088555000
	5/8"	16-088556000
	3/4"	16-088557000
	1"	16-088558000
	K2 GO GAUGE	16-088509000

TITAN INDUSTRIES, INC.
a world of products for the world of water

*Prices are subject to change without notice.
Returns are subject to a restock fee.
Special Orders are non-returnable.*

KITEC COMPOSITE PRESSURE PIPE

Item	Size	List Price per foot
ORANGE PEX-AL-PEX COMPOSITE PRESSURE PIPE	3/8" X 200'	16-011678000
	1/2" X 100'	16-011600000
	1/2" X 250'	16-011601000
	1/2" X 300'	16-011602000
	1/2" X 500'	16-011603000
	5/8" X 300'	16-011615000
	5/8" X 400'	16-011611000
	3/4" X 100'	16-011620000
	3/4" X 300'	16-011621000
	1" X 100'	16-011628000
1" X 500'	16-011632000	
BLUE PE-AL-PE COMPOSITE PRESSURE PIPE	1/2" X 100'	16-011645000
	1/2" X 250'	16-011646000
	1/2" X 500'	16-011647000
	5/8" X 400'	16-011650000
	3/4" X 100'	16-011655000
	3/4" X 300'	16-011656000
	1" X 100'	16-011660000
	1" X 500'	16-011662000

TITAN INDUSTRIES, INC.
a world of products for the world of water

*Prices are subject to change without notice.
 Returns are subject to a restock fee.
 Special Orders are non-returnable.*

NOTES

CALL US TODAY!

PO Box 308
East Hwy 30
Paxton, Nebraska 69155
800-658-4086
308-239-4281
308-239-4474 (fax)

11555 S. Highway 283
Dodge City, Kansas 67801
800-658-4078
620-225-6201
620-225-1171 (fax)

1203 S.E. Grand Blvd.
Oklahoma, City, Oklahoma 73129
800-749-8659
405-677-1290
405-677-1296 (fax)

112 Grant - Aurora Industrial Park
Aurora, Nebraska 68818
800-255-4188
402-694-4188
402-694-4511 (fax)

1912 West Harry
Wichita, Kansas 67213
866-323-9111
316-262-9111
316-262-9119 (fax)

TITAN INDUSTRIES, INC.
a world of products for the world of water

SUBMERSIBLE WIRE, STAKONS & HEAT SHRINKS

Item	Size	Part No.	List Price	Item	Size	Part No.	List Price	
TWISTED PVC W/GRD	14/3 SOLID	54-TW1430000		REPAIR SHRINK TUBE 100/PACK	3/4" X 4"	54-BHBK00740		
	14/2 SOLID	54-TW1420000			BULK BLACK HEAT SHRINK TUBE	3/8"X24"10-14	54-BHBK10143	
	12/3 SOLID	54-TW1230000		1/2" X 24" KIT 8		54-BHBLK8005		
	12/2 SOLID	54-TW1220000		3/4" X 24" KIT 4		54-BHBLK4007		
	10/3 SOLID	54-TW1030000		1" X 24" KIT 2		54-BHBLK2010		
	10/2 SOLID	54-TW1020000		BLACK HEAT SHRINK KIT		2W KIT 10-14	54-BHBSK10142	
	8/2 19STR	54-TW0820000				3W KIT 10-14	54-BHBSK10143	
	8/3 19STR	54-TW0830000				4W 10-14	54-BHBSK10144	
	6/3 19STR	54-TW0630000				2W KIT 8	54-BHBSK82000	
	4/3 19STR	54-TW0430000			3W KIT 8	54-BHBSK83000		
2/3 19STR	54-TW0230000		4W KIT 8		54-BHBSK84000			
			3W KIT 6		54-BHBSK63000			
			4W KIT 6		54-BHBSK64000			
			3W KIT 4		54-BHBSK43000			
			4W KIT 4		54-BHBSK44000			
			3W KIT 2	54-BHBSK23000				
			4W KIT 2	54-BHBSK24000				
FLAT PARALLEL PVC W/GRD	14/3 7STR	54-FP1430000		TUBING KIT	3/8" X 3" 4 EA STANDARD BLACK	54-BKTUB0083		
	14/2 7STR	54-FP1420000		EXTRA HEAVY TUBING SPLICE KIT	1/2" X 3" BLACK	54-BKTUB053H		
	12/3 19STR	54-FP1230000			CLEAR HEAT SHRINK KIT	3/8"X24"TUBING	54-CHBLK3802	
	12/2 19STR	54-FP1220000		2W 10-14		54-CHSK10142		
	10/3 19STR	54-FP1030000		3W #10-14		54-CHSK10143		
	10/2 19STR	54-FP1020000		4W #10-14		54-CHSK10144		
	8/3 19STR	54-FP0830000		2W #8		54-CHSK82000		
	8/2 19STR	54-FP0820000		3W #8		54-CHSK83000		
	6/3 19STR	54-FP0630000		4W #8		54-CHSK84000		
	4/3 19STR	54-FP0430000		4W EX HVY#8		54-CHSKXH840		
2/3 19STR	54-FP0230000		2W #6	54-CHSK62000				
			3W #6	54-CHSK63000				
			4W #6	54-CHSK64000				
			4W EX HVY#4	54-CHSKXH440				
FLAT JACKETED PVC W/GRD HEAVY DUTY THW	14/3 STR	54-FJ1430000		STA KONS CRIMP CONNECTORS BULK	#101214 100/BAG	ELCCRMP101400		
	14/2 STR	54-FJ1420000			#8 25/BAG	ELCCRMP8250		
	12/3 STR	54-FJ1230000			#6 12/BAG	ELCCRMP6120		
	12/2 STR	54-FJ1220000			#4 6/BAG	ELCCRMP4060		
	10/3 STR	54-FJ1030000			#2 6/BAG	ELCCRMP2060		
	10/2 STR	54-FJ1020000			GREEN- GROUND WIRE	14/1-SOLID	54-GR1410000	
8/3 STR	54-FJ0830000		12/1-19 STR	54-GR1210000				
8/2 STR	54-FJ0820000		10/1-19 STR	54-GR1010000				
6/3 STR	54-FJ0630000		8/1-19 STR	54-GR0810000				
4/3 STR	54-FJ0430000		6/1-19STR	54-GR0610000				
2/3 STR	54-FJ0230000							
FLAT JACKETED HEAVY DUTY W/GRD	1/0 3CON	54-FJHD10000		WIRE PRICES CHANGE OFTEN. PLEASE CALL FOR CURRENT PRICING.				
	2/0 3CON	54-FJHD20000		<i>Prices are subject to change without notice. Returns are subject to a restock fee. Special Orders are non-returnable.</i>				
CONDUCTOR W/GRD	1/0 ROUND 3	54-RD0100000		TITAN INDUSTRIES, INC. <i>a world of products for the world of water</i>				
	2/0 ROUND PUMP	54-RD0200000						
	2/3 ROUND PUMP	54-RD0203000						
	4/3 ROUND PUMP	54-RD0403000						
	6/3 ROUND PUMP	54-RD0603000						
FLAT YELLOW W/GRD	12/3 FL	54-YE1230000						
NEOPRENE SUB CABLE	12/2 W/GRD	ELCNEOPRECABL						
BLACK TAPE	3/4" WIDE ROLL	ELCTAPE007000						
	3/4" RUBBER SPLICING	ELCRUBBSPLICG						

TITAN INDUSTRIES, INC.
a world of products for the world of water

ELECTRIC CONTROLS

Item	Size	Part No.	List Price	Item	Size	Part No.	List Price
CLASS 16 STANDARD STARTER	16AD,AG,AH			SUBTROL PUMP PANEL	SIZE 1	ELCPMPPANL010	
	16BD,BG,BH				SIZE 2 460V	ELCPMPPANL020	
	16CD,CG,CH,CE				SIZE 3 460V	ELCPMPPANL030	
	16DD,DG,DH,DE				SIZE 3-1/2 460V	ELCPMPPANL035	
	16ED,EG,EH,EE				SIZE 4 460V	ELCPMPPANL040	
	16FD,FG,FH,FE						
	16GD,GG,GH,GE						
MAG STARTER	15HP 3PH 20HP	ELC1554291010 ELC16CHMAG20H		SUBTROL FUSES	110 AMP PANEL 125 AMP PANEL	ELCTRS110R000 ELCTRS125R000	
480V PUMP PANEL SQUARE D	30HP 3PH 40-50HP 3PH	ELCSSD4030000 ELCSSE4050000		SUBTROL CHIPS	7-1/2HP 20HP 25HP 30HP 40HP 50HP 60HP 75HP 100HP	ELC1520409070 ELC1520409190 ELC1520409230 ELC1520409260 ELC1520409290 ELC1520409310 ELC1520409330 ELC1520409350 ELC1520409370	
BREAKER BOX GE	NEMA 1 NEMA 1	ELCBBTL240R10 ELCBBTPL412C0		SUBTROL PLUS RETROFIT KIT	TO 30 HP 230V TO 100HP 460V 125HP 460V 150HP 460V TO 125HP 575V 150HP 575V	ELCFRKR2300000 ELCFRKR4600000 ELCFRKR4601250 ELCFRKR4601500 ELCFRKR5751250 ELCFRKR5751500	
	1-1/4" HUB WATER TIGHT 1-1/4" UNIVERSAL HUB	ELCBBTC125000 ELCTC12500000		DISCONNECT SWITCH	FURNAS	ELCD461200100	
OUTLETS, BOXES & COVERS	OUTLET BOX DOUBLE BOX SINGLE COVER 115V 20A RECEPTACLE IVORY RECEPTACLE PLATE 30 AMP 3PH GROUNDING OUTLET	ELCOUTLETBOX0 ELCOUTLTBxDBl ELCOUTLTBXCov ELC8LEVCR2000 ELC8070310000 ELCGROU30AM3P		SPECIALTY CONTROL BOXES	PUMPTEC PUMPTEC PLUS QD PUMPTEC FURNACE NEMA1 HAYS CP CONTROL	ELCFRKPUMPCON ELCFRKPUMPPLU ELCFRKPUMPTQC ELC16DHNEMA10 ELC7QU5CP0000	
	24HR TIME CLOCK	ELCTIMECLOCK0		OPEN TANK FLOAT SWITCHES	FORMR PUMP UP DG2 PUMP DOWN BOS HAR PUMP UP BOS HAR PMP DWN	ELCDG20OPEN00 ELCGG2CLOSE00 ELC860U120100 ELC860D120200	
LOAD CENTERS	40AMP NEMA3 125AMP NEMA1	ELCTPL240RCV0 ELCTPL412C000		PLASTIC FLOAT SWITCH WITH CORD			
JUNCTION BOX & PANEL	JUNCTION BOX PANEL FOR BOX	ELCW1GB100806 ELCW1GP100800		A2-5 SEWAGE PUMP SWITCH		ELCSEWAGPUMP	
GE BREAKERS	15A SINGLE POLE 20A SINGLE POLE 15A DBL POLE 20A DBL POLE 30A DBL POLE	ELCTHQL111500 ELCTHQL211200 ELCTHQL211500 ELCTHQL212000 ELCTHQL213000		SQUARE D SUMP PUMP SWITCH		ELCSUMPMSWSQD	
PRESSURE SWITCHES	20/40 PSI 30/50 PSI 40/60 PSI 60/80 PSI 30/50 HVY DUTY 40/60 HVY DUTY 60/80 HVY DUTY 80/100 HVY DUTY 30/50 MANUAL 30/50LOWCUTOFF	ELCPRSW20/400 ELCPRSW30/500 ELCPRSW40/600 ELCPRSW60/800 ELCPRSWHD3/50 ELCPRSWHD4/60 ELCPRSWHD6/80 ELCPRSWH8/100 ELCPRSWM30/50 ELCLOWWTR30/5		10'CORD PIGGYBACK PLUG 230V PUMP UP SWITCH		ELC9036LG2120	
				HIGH WATER SUMP PUMP ALARM WITH LIGHT & HORN	A4-1 NEMA1 A4-7 NEMA2	ELCHIWATRSA10 ELCHIWATRTRA20	
				HEAT TAPE	9' LONG	ELCHEATTAPE90	

TITAN INDUSTRIES, INC.
a world of products for the world of water

*Prices are subject to change without notice.
Returns are subject to a restock fee.
Special Orders are non-returnable.*

ELECTRIC CONTROLS

Item	Size	Part No.	List Price	Item	Size	Part No.	List Price
B/W LOW WATER CUT OFF CONTROL	115V	54-AW21-100					
	230V 1PH/3PH	54-AW21-200					
	460V 3PH	54-AW21-300					
ELECTRODES	AW22	54-AW220000					
SUSPENSION WIRE	500' BLACK	54-AW23B500					
	500' RED	54-AW23R500					
	1000' BLACK	54-AW23B100					
	1000' RED	54-AW23R100					

IRRIGATION WIRE

Item	Size	Part No.	List Price	Item	Size	Part No.	List Price
IRRIGATION WIRE	SPR18/3	54-IR1830000					
	SPR18/4	54-IR1840000					
	SPR18/4	54-IR1840000					
	SPR18/4	54-IR1840000					
	SPR18/6	54-IR1860000					
	SPR18/6	54-IR1860000					
	SPR18/6	54-IR1860000					
	SPR18/8	54-IR1880000					
	SPR18/8	54-IR1880000					
	SPR18/8	54-IR1880000					
	SPR18/10	54-IR1810000					
	SPR18/10	54-IR1810000					
	SPR18/13	54-IR1813000					
	SPR18/13	54-IR1813000					
	SPR18/13	54-IR1813000					

**WIRE PRICES CHANGE OFTEN.
PLEASE CALL FOR CURRENT PRICING.**

TITAN INDUSTRIES, INC.
a world of products for the world of water

*Prices are subject to change without notice.
Returns are subject to a restock fee.
Special Orders are non-returnable.*

CONDUIT & WIRE

Item	Size	Part No.	List Price	Item	Size	Part No.	List Price
PVC CONDUIT SCHEDULE 40	1/2" X 10'	ELC005SC4010B		PVC CONDUIT LONG SWEEP 90 ELLBOW	1/2"	19-406005ES0	
	3/4" X 10'	ELC007SC4010B			3/4"	19-406007ES0	
	3/4" X 20'	ELCCON070020B			1"	19-406010ES0	
	1" X 20'	ELCCON010020B			1-1/4"	19-406012ES0	
	1-1/4" X 10'	ELC012SC4010B			1-1/2"	19-406015ES0	
	1-1/2" X 10'	ELC015SC4010B			2"	19-406020ES0	
	2" X 10'	ELC020SC4010B			2-1/2"	19-406025ES0	
	2" X 20'	ELC020SC4020B			3"	19-406030ES0	
	2-1/2" X 10'	ELC025SC4010B			4"	19-406040ES0	
	3" X 10'	ELC030SC4010B			6"	19-406060ES0	
	3" X 20'	ELC030SC4020B					
	4" X 10'	ELC040SC4010B					
	4" X 20'	ELC040SC4020B					
	5" X 10'	ELC050SC4010B					
5" X 20'	ELC050SC4020B						
6" X 10'	ELC060SC4010B						
6" X 20'	ELC060SC4020B						
PVC CONDUIT COUPLERS SCHEDULE 40	3/4"	ELCCONCOP0070		FLEX CONDUIT	1/2" ALUMINUM	ELCCONALUTB05	
	1"	ELCCONCOP0100			3/4" ALUMINUM	ELCCONALUTB07	
	1-1/4"	ELCCONCOP0120		THIN WALL CONDUIT	3/4" X 10'	ELCCONTHI0071	
	1-1/2"	ELCCONCOP0150			3/4" X 20'	ELCCONTHI0072	
	2"	ELCCONCOP0200		THIN WALL MALE ADAPTER	3/4"	ELCCONTHIM007	
3"	ELCCONCOP0300						
PVC CONDUIT FEMALE ADAPTERS SCHEDULE 40	3/4"	ELCCONFAD0070		UF W/GRD	10/3 UF	54-UF1030000	
	1"	ELCCONFAD0100			12/2 UF	54-UF1220000	
	1-1/4"	ELCCONFAD0120			12/3 UF	54-UF1230000	
	1-1/2"	ELCCONFAD0150		DIRECT BURY W/GRD	10/3 UF	54-DB1030000	
	2"	ELCCONFAD0200			12/2 UF	54-DB1220000	
2-1/2"	ELCCONFAD0250						
3"	ELCCONFAD0300			TRACER	#12 BLUE	54-TRAC12000	
4"	ELCCONFAD0400				#14	54-TRAC14000	
PVC CONDUIT MALE ADAPTERS SCHEDULE 40	1/2"	ELCCONMAD0050		ALUM. QUAD W/ RED GRD WIRE	2/0-	54-QD0200000	
	3/4"	ELCCONMAD0070			4/0-	54-QD0400000	
	1"	ELCCONMAD0100		TRIPLEX W/GRD	1/0 TRIPLEX	54-TRIPL0100	
	1-1/4"	ELCCONMAD0120			#2 TRIPLEX	54-TRIPL0200	
	1-1/2"	ELCCONMAD0150			4/0 TRIPLEX	54-TRIPL0400	
	2"	ELCCONMAD0200			2/0 TRIPLEX	54-TRIPL2000	
3"	ELCCONMAD0300			SNGL STRAND W/GRD WIRE	#10-1STRANDED	54-GR101SIST	
4"	ELCCONMAD0400				#10-1 SOLID	54-GR101SNGS	
ELECTRIC LOCKNUT	1/2"	ELCLOCKNUT005		COPPER WIRE	#1	54-COPPER#10	
	3/4"	ELCLOCKNUT007			#2	54-COPPER#20	
	1"	ELCLOCKNUT010					
	1-1/4"	ELCLOCKNUT012					
	1-1/2"	ELCLOCKNUT015					
	2"	ELCLOCKNUT020					

**WIRE PRICES CHANGE OFTEN.
PLEASE CALL FOR CURRENT PRICING.**

Prices are subject to change without notice.

Returns are subject to a restock fee.

Special Orders are non-returnable.

TITAN INDUSTRIES, INC.
a world of products for the world of water

DRILLING PRODUCTS

Item	Size	Part No.	List Price	Item	Size	Part No.	List Price
SAND 50# BAGS	4 X 8	55-SAND04080		UNTREATED BENTONITE TABLETS	1/4"	55-TABR025GL	
	4 X 10	55-SAND04105			3/8"	55-TABR035GL	
	6 X 9	55-SAND06095			1/2"	55-TABR055GL	
	6 X 12	55-SAND06125			5 GALLON BUCKETS	1/4"	55-BAR02BENT
	8 X 12	55-SAND08125		1/2"		55-BAR05UNTR	
	8 X 16	55-SAND0816P					
	10 X 20	55-SAND10205					
	12 X 20	55-SAND12205		TREATED BENTONITE TABLETS	1/4"	55-TABC025GL	
	16 X 30	55-SAND16305			3/8"	55-TABC035GL	
	20 X 40	55-SAND20405			1/4"	55-BAR01TRPE	
	30 X 70	55-SAND30705			3/8"	55-BAR03TRPE	
		100 MESH	55-MESS10050		BUCKETS	1/2"	55-BAR02TRPE
SILICA SAND 3000# SUPER- SACKS	4 X 10	55-SAND0410S		BENTONITE GROUTS 50# BAGS	GEOTHERMAL	55-GEGROUT50	
	6 X 9	55-SAND0609S			GROUNDING	55-GRGROUT50	
	8 X 12	55-SAND0812S			PUREGOLD	55-PUREGR050	
	8 X 14	55-SAND0814S			GRANULAR	55-VOLCLAY1S	
	8 X 16	55-SAND0816S			QUIK-GROUT	55-BARQUIGRO	
	10 X 20	55-SAND1020S			AQUAGUARD	55-BARAQUGUA	
	16 X 40	55-SAND1640S		AQUAGROUT CATYLIST	55-BARGROCAT		
20 X 40	55-SAND2040S		THERMAL GROUT LITE PART 1	55-GEOTGL100			
BLASTING SAND	#16X100# BAG	55-SAND#1610		DRILLING POLYMERS			
	#16X3000#	55-SAND#16SS		INSTAPACK - 1 GAL	55-LPLYMIP1G		
50# BAGS BENTONITE DRILLING FLUIDS	PREMIUMGEL	55-PREMGL050		INSTAPACK - 5 GAL	55-LPLYMIP5G		
	SUPERGEL-X	55-SUPERX050		INSTA-VIS DRY - 14# PAIL	55-INSTAVISD		
	PUREGOLD GEL	55-PUREGL050		INSTA-VIS PLUS - 5 GAL	55-INSTAVISP		
	HYDRAUL-EZ	55-HYDRAL050		PUREGOLD CLEANDRILL	55-PGLDCLD50		
	QUIKGEL	55-BARQUIGEL		REL-PAC - 2# BAG	55-RELPAC020		
	AQUA GEL	55-BARAQUAGE		REL-PAC - 50#	55-RELPAC500		
	BORE GEL	55-BOREGEL50		SUPER PAC - 1 GALLON	55-SPPAC1GAL		
	AQUAGEL GOLD	55-BARAQUGOL		SUPER PAC - 5 GALLON	55-SPPAC5GAL		
100# BAGS BENTONITE	PREMIUMGEL	55-PREMGL100		SUSPEND-IT - 2# BAG	55-SUSPENDIT		
	AQUA GEL	55-BARAQUGEL		SUSPEND-IT - 25# PAIL	55-SUSPEND25		
BENTONITE SEALANTS	CRUMBLES	55-CRUMBLES		VARIFLO QD - 25# PAIL	55-VARIFLO25		
	CS GRANULAR	55-CSGRANULR		EZ MUD DP 14# PAIL	55-BAR14#EZM		
	3/8 MED CHIPS	55-MEDCHIP38		EZ MUD 1 GAL	55-BARGLEZMU		
	COARSECHIPS	55-CRSCHIP34		EZ MUD 5 GAL	55-BAR5GLMUD		
	3/8" HOLEPLG	55-BAR03HOLE		SUPER MUD 5 GAL	55-SUPRMUD5G		
	BENSEAL	55-BARBENSEA		INSTA-FLOC - 5 GALLON	55-INSTAFLO5		
	EZ SEAL	55-BAREZSEAL		SHORE PAC GCV - 7.5# JUG	55-SHOREPAC7		
SUPERSACK	3/8 CHIPS	55-MEDCHIP38SS		SHORE PAC GCV - 55#	55-SHOREPAC5		
				25# REVERT	55-REVERT25#		

TITAN INDUSTRIES, INC.
a world of products for the world of water

*Prices are subject to change without notice.
Returns are subject to a restock fee.
Special Orders are non-returnable.*

DRILLING PRODUCTS

Item	Size	Part No.	List Price	Item	Size	Part No.	List Price
DRILLING ADDITIVES				SHALE TRAP	2" X 5"	43-920050000	
ATTAPULGITE		55-ATTAPULGIT			4" X 6"	43-940060000	
BARITE		55-BARITE1000			5" X 6"	43-950060000	
DE-CHLOR - 5 GALLON		55-DECHLOR5G			5" X 8"	43-950080000	
DEFOAMER		55-DEFOAMER5			6" X 10"	43-960010000	
DRAGNET - 3/4# BAG		55-DRAGNET34			8" X 12"	43-980012000	
DRILL-TERGE - 5 GALLON		55-DRILLT5GL			12"X20"W/12"CL	43-912020000	
LEB-CD 1 GALLON		55-LEBCD1GAL		9-7/8" DRILL BIT			
MACRO-FILL - 14# PAIL		55-MACROFL14		NONSEALED BEARINGS		55-MILDRLNOB	
MACRO-FILL - 55#		55-MACROFL55		SEALED BEARINGS		55-MILDRLW/B	
MULTI-SEAL - 40#		55-MULTISEAL					
PURE GOLD LUBE - 8# PAIL		55-PUREGLUB					
SODA ASH - 50# BAG		55-SODAASH50					
SODA ASH - 50# PAIL		55-SODAASH5P					
SUPER THIN - 5 GAL		55-SUPERH5G					
VERSA FOAM - 5 GAL		55-VERSAFM5G					
VERSA FOAM - 55 GAL		55-VERSAFM55					
VERSA FOAM PLUS - 5 GAL		55-VERSAFP5G					
VERSA FOAM PLUS - 55 GAL		55-VERSAFP55					
JOINT COMPOUND -18# PAIL		55-VOLCLAYJC					
QUIK-FOAM 5 GALLON		55-BARQUIFO5					
QUICK FOAM 55 GALLON		55-QCKFOAM5G					
STABELITE - 5 GALLON		55-STABELT5G					
CASING SEAL 50# BAG		55-CASGSEL50					
OPTI-FLOW WELL REHAB PRODUCTS							
DPA - 50# PAIL		55-DPABUCKET					
LBA - 5 GAL		55-LBABUCKET					
BMR - 50# PAIL		55-BMR50PAIL					
SC-200 - 5 GAL		55-SC2005GAL					
AQUACLEAR PFD 5 GALLON		55-BARAQUCL5					
GRANULAR ACID 5 GALLON		39-CLNRACD55					
DRILLING PRODUCTS							
1 GALLON PAIL KOPR KOTE		55-JL1002300					
30# PAIL POLY ORE		55-POLORE30#					
PORTLAND CEMENT - 94#		55-PORTGEMNT					
94# BAGS CEMENT		39-CEMENT94L					
60# SACRETE		55-SACRETE60					
80# SACRETE		55-SACRETE80					
LIME 50 # BAGS		55-LIME500000					

TITAN INDUSTRIES, INC.
a world of products for the world of water

*Prices are subject to change without notice.
Returns are subject to a restock fee.
Special Orders are non-returnable.*

DRILLING SUPPLIES CROSS REFERENCE GUIDE

PRODUCT DESCRIPTION	GETCO	NL BAROID
200 BBL. YIELD DRILLING FLUID	SUPER GEL-X	QUIK GEL
API 90 BBL. YIELD DRILLING FLUID	PREMIUM GEL	AQUA GEL
HORIZONTAL DRILLING FLUID	HYDRAUL-EZ	BORE GEL
UNTREATED BENTONITE	PUREGOLD GEL	AQUA GEL GOLD
GRANULAR BENTONITE	C/S GRANULAR CRUMBLES	NATIONAL 30 BEN SEAL
HOLE SEALING TABLETS	VOLCLAY TABLETS	BENTONITE TABLETS
HOLE ABANDONMENT MATERIAL	VOLCLAY CHIPS	HOLE PLUG
HIGH SOLIDS BENTONITE GROUT	VOLCLAY GROUT	QUICK GROUT (BEN SEAL EZ MUD)
LIQUID POLYMER	INSTA PAC 425	EZ MUD
DRY POLYMER	REL PAC	QUIK TROL
DRILLING FOAM	VERSA FOAM	QUIK FOAM
ORGANIC POLYMER	VARIFLO	LOLOSS (JOHNSON'S REVERT)
DRILLING DETERGENT	DRILL-TERGE	CON DET

NOTES

CALL US TODAY!

PO Box 308
East Hwy 30
Paxton, Nebraska 69155
800-658-4086
308-239-4281
308-239-4474 (fax)

11555 S. Highway 283
Dodge City, Kansas 67801
800-658-4078
620-225-6201
620-225-1171 (fax)

1203 S.E. Grand Blvd.
Oklahoma, City, Oklahoma 73129
800-749-8659
405-677-1290
405-677-1296 (fax)

112 Grant - Aurora Industrial Park
Aurora, Nebraska 68818
800-255-4188
402-694-4188
402-694-4511 (fax)

1912 West Harry
Wichita, Kansas 67213
866-323-9111
316-262-9111
316-262-9119 (fax)

TITAN INDUSTRIES, INC.
a world of products for the world of water

WELL PITS & CULVERTS

Item	Size	Part No.	List Price per Foot	Item	Size	Part No.	List Price Each
CULVERT 16 GAUGE SPIRAL	12" X 20'	SGPCS12016G20		GALVANIZED METER BOX AND TANK PITS	24" X 4'	45-GMB244000	
	15" X 20'	SGPCS15016G20			36" X 4'	45-GMB364000	
	18" X 20'	SGPCS18016G20			36" X 5'	45-GMB365000	
	21" X 30'	SGPCS21016G20			36" X 6'	45-GMB366000	
	24" X 20'	SGPCS24016G20			42" X 3'	45-GMB423000	
CULVERT 14 GAUGE SPIRAL	30" X 20'	SGPCS30014G20			42" X 4'	45-GMB424000	
	36" X 20'	SGPCS36014G20			42" X 5'	45-GMB425000	
	42" X 20'	SGPCS42012G20			42" X 6'	45-GMB426000	
					48" X 3'	45-GMB483000	
CULVERT 12 GAUGE SPIRAL	48" X 20"	SGPCS48012G20			48" X 4'	45-GMB484000	
	54" X 20'	SGPCS54012G20			48" X 5'	45-GMB485000	
	60" X 20'	SGPCS60012G20			48" X 6'	45-GMB486000	
CULVERT 16 GAUGE RIVITED	12" X 20'	SGPCR12016G20			48" X 7'	45-GMB487000	
	15" X 20'	SGPCR15016G20			60" X 3'	45-GMB603000	
	18" X 20'	SGPCR18016G20			60" X 4'	45-GMB604000	
	21" X 30'	SGPCR21016G20			60" X 5'	45-GMB605000	
	24" X 20'	SGPCR24016G20			60" X 6'	45-GMB606000	
CULVERT 14 GAUGE RIVITED	30" X 20'	SGPCR30014G20			72" X 3'	45-GMB723000	
	36" X 20'	SGPCR36014G20			72" X 4'	45-GMB724000	
	42" X 20'	SGPCR42014G20		72" X 5'	45-GMB725000		
CULVERT 12 GAUGE RIVITED	48" X 20'	SGPCR48012G20		72" X 6'	45-GMB726000		
	54" X 20'	SGPCR54012G20		84" X 3'	45-GMB843000		
	60" X 20'	SGPCR60012G20		84" X 4'	45-GMB844000		
CULVERT BAND	10"	45-CB1000000		84" X 5'	45-GMB845000		
	12"	45-CB1200000		84" X 6'	45-GMB846000		
	15"	45-CB1500000		96" X 3'	45-GMB963000		
	18"	45-CB1800000		96" X 4'	45-GMB964000		
	21"	45-CB2100000		96" X 5'	45-GMB965000		
	24"	45-CB2400000		96" X 6'	45-GMB966000		
	30"	45-CB3000000					
	36"	45-CB3600000					
	42"	45-CB4200000					
	48"	45-CB4800000					
	54"	45-CB5400000					
	60"	45-CB6000000					
				EXTENSION FOR METER BOXES & TANK PITS	36" X 18"	45-EXT361800	
					48" X 12"	45-EXT481200	
					48" X 18"	45-EXT481800	
					48" X 24"	45-EXT482400	
					60" X 12"	45-EXT601200	
					60" X 18"	45-EXT601800	
					60" X 24"	45-EXT602400	
					72" X 12"	45-EXT721200	
					72" X 18"	45-EXT721800	
					72" X 24"	45-EXT722400	
				GALVANIZED FLANGED LID FOR METER BOXES & TANK PITS	24"	45-GFL240000	
					30"	45-GFL300000	
					36"	45-GFL360000	
					42"	45-GFL420000	
					48"	45-GFL480000	
					60"	45-GFL600000	
					72"	45-GFL720000	
					84"	45-GFL840000	
					96"	45-GFL960000	

TITAN INDUSTRIES, INC.
a world of products for the world of water

*Prices are subject to change without notice.
Returns are subject to a restock fee.
Special Orders are non-returnable.*

KENYON TOOLS

Part No.	Description	List Price
RAKES		
60-115140000	24" ALUMINUM LANDSCAPE RAKE 66" HANDLE	
60-321180000	18" PRO-FLEX LAWN RAKE 48" ALUMINUM HANDLE	
GARDEN TOOLS		
60-36201RED0	BEDDING MATTOCK RED HANDLE	
60-36301RED0	CULTIVATING MATTOCK RED HANDLE	
60-354100000	4 PRONG RIGHT ANGLE CULTIVATOR 63" VINYL SLEEVE HANDLE	
60-343120000	GARDEN HOE 66" VINYL SLEEVE HANDLE	
60-343160000	3-IN-1 GARDEN TOOL 66" VINYL SLEEVE HANDLE	
60-344200000	ONION HOE 63" VINYL SLEEVE HANDLE	
60-344230000	MEADOW HOE 63" VINYL SLEEVE HANDLE	
60-344240000	DUTCH HOE 66" VINYL SLEEVE HANDLE	
60-711300000	SUPER FORK D WOOD HANDLE	
60-713110000	10 TINE FORK 49" ALUMINUM HANDLE	
60-713140000	4 TINE FORK 49" ALUMINUM HANDLE	
60-32614A000	14" BOW RAKE 66" ADJUSTABLE ALUMINUM HANDLE	
SHOVELS		
60-212260000	6" X 11" TRENCHING SHOVEL WOOD HANDLE	
60-212740000	4" X 11" TRENCHING SHOVEL FIBERGLASS HANDLE	
60-213260000	6" BULLHEAD TRENCH SHOVEL D WOOD HANDLE	
60-213730000	3" X 11" TRENCHING SHOVEL BLUE FIBERGLASS HANDLE HD	
60-213740000	4" X 11" TRENCHING SHOVEL ORANGE FIBERGLASS HANDLE HD	
60-213750000	5" X 11" TRENCHING SHOVEL RED FIBERGLASS HANDLE HD	
60-213760000	6" X 11" TRENCHING SHOVEL GREEN FIBERGLASS HANDLE HD	
60-214230000	3" CREW LINE TRENCHING SHOVEL WOOD HANDLE	
60-214240000	4" CREW LINE TRENCHING SHOVEL WOOD HANDLE	
60-214250000	5" CREW LINE TRENCHING SHOVEL WOOD HANDLE	
60-214260000	6" CREW LINE TRENCHING SHOVEL WOOD HANDLE	
60-265540000	14" DRAIN SPADE RED D FIBERGLASS HANDLE XHD	
60-265740000	14" DRAIN SPADE 48" YELLOW FIBERGLASS HANDLE HD	
60-265840000	14" DRAIN SPADE YELLOW D FIBERGLASS HANDLE HD	
60-266000000	EDGER 48" WOOD HANDLE	
60-241230000	FLORAL BLADE SHOVEL 48" WOOD HANDLE	
60-241320000	#2 ROUND POINT SHOVEL D WOOD HANDLE	
60-244220000	#2 IRRIGATION SHOVEL 48" WOOD HANDLE	
60-244420000	#2 IRRIGATION SHOVEL 48" RED FIBERGLASS HANDLE XHD	
60-244720000	#2 IRRIGATION SHOVEL 48" YELLOW FIBERGLASS HANDLE HD	
60-251220000	#2 ROUND POINT SHOVEL 48" WOOD HANDLE	
60-251420000	#2 ROUND POINT SHOVEL 48" RED FIBERGLASS HANDLE XHD	
60-251460000	#2 ROUND POINT/CLOSED BACK SHOVEL 48" FIBERGLASS HANDLE	
60-252420000	#2 SQUARE POINT SHOVEL 48" RED FIBERGLASS HANDLE XHD	
60-274200000	#0 SUPER SOLID DEEP BOWL SHOVEL WOOD HANDLE	
60-276410000	#1 CAPROCK IRRIGATION SHOVEL 48" GRAY FIBERGLASS HANDLE XHD	
60-281320000	#12 ALUMINUM SCOOP SHOVEL D WOOD HANDLE	
60-299380000	POLY SNOW SHOVEL D WOOD HANDLE	
IRRIGATION ACCESSORIES		
60-440040000	4" SPRINKLER HEAD TRIMMER	

TITAN INDUSTRIES, INC.
a world of products for the world of water

*Prices are subject to change without notice.
Returns are subject to a restock fee.
Special Orders are non-returnable.*

KENYON TOOLS

Part No.	Description	List Price
HARDSCAPE TOOLS		
60-570100000	CONCRETE COME-A-LONG 60" ALUMINUM HANDLE	
60-812140000	PUSH BROOM 24" MARRON STIFF POLY BRISTLE 60" VINYL ALUMI	
60-810140000	PUSH BROOM 24" DUAL BRISTLE 60" VINYL SLEEVED ALUMINUM HANDLE	
60-811140000	PUSH BROOM 24" BLACK MEDIUM POLY BRISTLE 60" VINYL ALUMINUM	
STRIKING/PRYING PRODUCTS		
60-622040000	14 LB SAN ANGELO BAR	
60-624070000	17 LB POST HOLE DIGGER BAR	
60-491860000	8" X 8" HAND DIRT TAMP 60" STEEL HANDLE	
60-695100000	HD POST DRIVER C HANDLE 3-1/2" ID CAP	
60-662430000	3LB ENGINEERING HAMMER 15" FIBERGLASS HANDLE	
60-662440000	4LB ENGINEERING HAMMER 15" FIBERGLASS HANDLE	
60-663480000	8LB DOUBLE FACED SLEDGE 36" FIBERGLASS HANDLE	
60-650400000	PULASKI AXE 3-1/2LBS 36" FIBERGLASS HANDLE	
REPLACEMENT PARTS		
60-962150000	15" FIBERGLASS HANDLE FOR 3 & 4 LB ENGINEERING HAMMER	
60-962220000	22" FIBERGLASS HANDLE FOR 6 TO 16 LB FORMING SLEDGE	
60-962340000	34" FIBERGLASS HANDLE FOR 8 TO 12 LB SLEDGE	
MALCO BRANDED TOOLS		
60-M10000000	3/8" X 100' LONG TAPE	
60-T425000000	1" X 25' TAPE MEASURE	
60-MW1000000	10" MEASURING WHEEL	
60-MW1900000	19" MEASURING WHEEL	

WELLCRAFT EGRESS WINDOW WELLS

Part No.	Description	Weight	List Price
60-WWAG20670	20-67 EGRESS WELL	185	712.00
60-WWAG2067C	20-67 CLEAR COVER	25	258.00
60-WWAG20672	20-67 EGRESS WELL - 2 TIERS	125	541.00

**Tiered Step Design with
Granite Finish - 20-67**

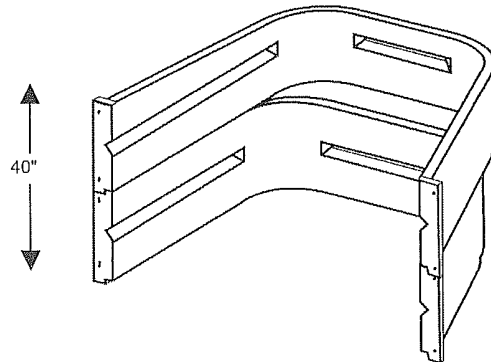
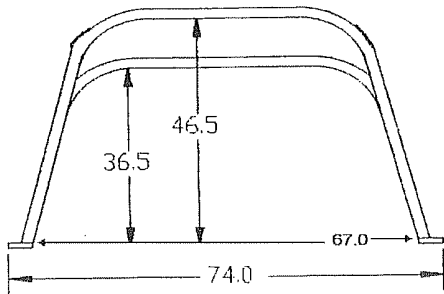
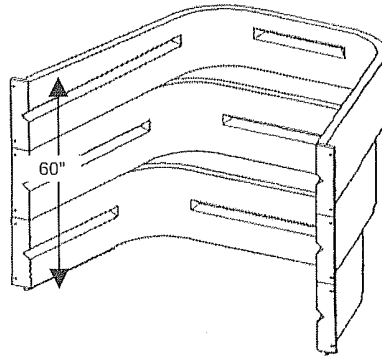
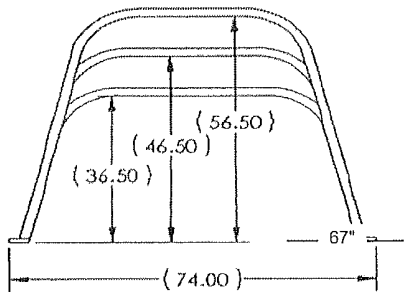

Prices are subject to change without notice.

Returns are subject to a restock fee.

Special Orders are non-returnable.

TITAN INDUSTRIES, INC.
a world of products for the world of water

WELLCRAFT EGRESS WINDOW WELLS

Part No.	Description	Weight	List Price
60-WWAG20600	20-60 Wellcraft Egress Well	100	586.00
60-WWAG2060C	20-60 Egress Well Clear Cover - 72" Wide	21	239.00
60-WWAG2060E	20-60 12" Extension	18	187.00
60-WWAG20400	20-40 Wellstone Egress Well	70	403.00
60-WWAG2040C	20-40 Egress Well Clear Cover - 60" Wide	17	208.00

Sculpted Step Design with Granite Finish - 20-60

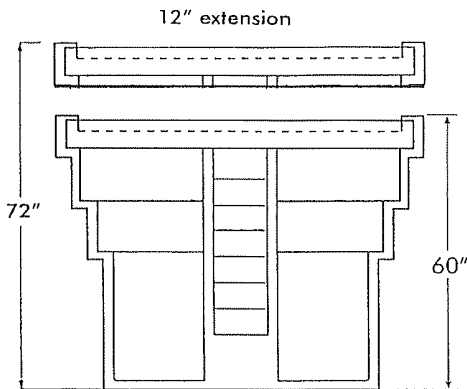
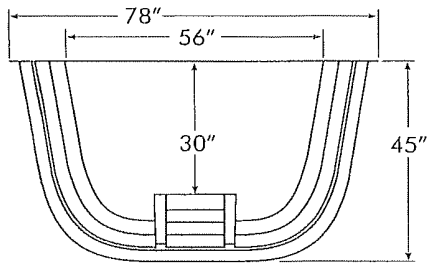

Granite Finish with Rungs - 20-40

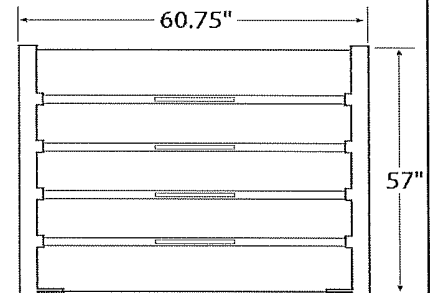
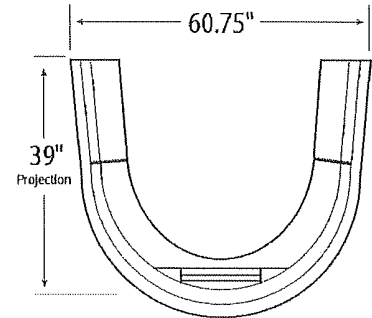

Features:

- Built-in ladder for emergency exits
- Maintenance free PolyTUFF® construction
- Ability to endure extremely low temperatures
- Drain opening
- 5 year limited warranty

Benefits:

- Fully complies with lower level egress requirements (IRC 2000)
- Easy installation due to one-piece construction
- Provides a quick, safe exit from basements or lower level rooms
- Allows a greater amount of natural light into the lower level
- Adds beauty and functionality to the interior and exterior



TITAN INDUSTRIES, INC.
a world of products for the world of water

Prices are subject to change without notice.
Returns are subject to a restock fee.
Special Orders are non-returnable.

FLOWMIX RAPID ASPHALT REPAIR KIT

Part No.	Description	List Price Each
60-FLMIX025GAL	2.5 GAL BUCKET FLOMIX	
60-FLMIX050GAL	5 GAL BUCKET FLOMIX	
	2.5 GAL PALLET QTY - 64 BUCKETS	
	5 GAL PALLET QTY - 48 BUCKETS	
60-FLMIX400MIX	4" FLOMIX SUPER MUD MISER KIT	

FLOMIX WATERPROOFS, RESTORES ASPHALT STRENGTH & PREVENTS POTHOLES.

SIMPLE, FAST, SAFE

ASHPHALT REPAIR DAY OR NIGHT: ELIMINATES THE NEED FOR HOTMIX AND ROLLER COMPACTING FOR PERMANENT ASPHALT REPAIR.

NO DIGOUTS: PAVEMENT STRENGTH IS RESTORED OVER ALLIGATORING, RAVELED, CRACKED OR FATIGUED ASPHALT WITH NO ASPHALT REMOVAL.

FAST COMPLETION: UP TO 50-SQUARE FEET OF REPAIRS IN TEN MINUTES.

APPLIED IN 4 SIMPLE STEPS: CLEAN SURFACE, PREPARE FLOMIX, APPLY FLOMIX, ADD TOPPING SAND.

REPAIRS TO-GRADE: PROVIDES A SMOOTH HIGH-TRACTION SURFACE.

ENVIRONMENTALLY SAFE: NO FUMES, NO ODORS, NO TOXIC WASTE, USES COLD PROCESS, ELIMINATING BURN RISK.

USES FOR FLOMIX

RESTORE SURFACE, GRADE, STRUCTURAL STRENGTH AND TRACTION OVER ALLIGATORING, RAVELED, SPALLED, FATIGUED, DAMAGED, OR POORLY-COMPACTED ASPHALT.

MATCH GRADES, FILL BIRDBATHS TO ELIMINATE BLACK ICE, REPAIR COLD JOINTS AND UTILITY CUTS.

FILL IN RUTTING AND SUNKEN PAVEMENT.

REPAIR ASPHALT PRIOR TO SEAL-COATING, SLURRY SEALING OR OVERLAYING TO STOP REFLECTIVE CRACKS.

TITAN INDUSTRIES, INC.
a world of products for the world of water

Prices are subject to change without notice.

Returns are subject to a restock fee.

Special Orders are non-returnable.

WATER SOFTENERS, FILTERS & ACCESSORIES

Item	Size	Part No.	List Price	Item	Size	Part No.	List Price
WATER SOFTNER				REVERSE OSMOSIS UNIT			
24,000 GRAIN		39-CA24TP000		25 GPD		39-TFC25SA00	
32,000 GRAIN		39-CA32TP000		RO FAUCET 3/8" AIRGAP L/4 39-57005C102			
32,000 GRAIN 2 TANK		39-AS32TP000		CARBON POST REPLACEMENT FOR TFC25SA 39-M3GAC0000			
48,000 GRAIN 2 TANK		39-AS48TP000		REPLACEMENT MEMBRANE 25 GPD FOR TFC UNIT 39-M3TFC0000			
WATER SOFTNER AUTO VALVE 39-20921C112				PRE FILTER FOR CTA14 39-57011M3SE			
HEAD	FOR AS32T-P	39-20921C113		SEDIMENT PRE-FILTER FOR TFC25SA 39-MESED0000			
O-RING				MICRON DISPOSABLE FILTER W/1/4" BARBS 39-MCRNFLT02			
FLOW CONTROL FOR #2056 & #2092 VALVE		39-20251C254		SEDIMENT WATER FILTER UNIT 3/4" 39-N14HC10C0			
		39-20561C216		TASTE & ODOR CARTRIDGE FOR 14HC-10C 39-N14PAC110			
SEAL ASSEMBLY FOR #2056 VALVE FOR ISOBAR VALVE 39-20561C253 39-20922C204				SEDIMENT CARTRIDGE FOR 14HC-10C 39-N14SP110C			
PISTON ASSEMBLY FOR #2056 VALVE FOR ISOBAR VALVE 39-20561C254 39-20922C203				THERMOPLASTIC 6 PACK			
BIRM	1 CUBIC FOOT	39-BM1000000		2"		39-02THER6PK	
CATION32 SOFTNER RESIN 39-SR1000000				3"		39-03THER6PK	
ACTIVATED CARBON	1 CUBIC FOOT	39-AC1000000		4"		39-04THER6PK	
MANGANESE GREENSAND 39-MG1000000				10" AUTOMATIC FILTER PROVECTOR SYSTEM 39-AF10P0000			
NEUTRALIZER	1 CUBIC FOOT	39-NC1000000		VU FLO FILTER			
MULTI-BLEND	1 CUBIC FOOT	39-MB1000000		1-1/2" W/PURGE 100 MESH		39-NT150100P	
D GRAVEL	20 LBS	39-DG0200000		1-1/2" W/PURGE 140 MESH		39-NT150140P	
FILTER AGGREGATE	1 CUBIC FOOT	39-FA100A900		1-1/2" W/400 MESH		39-NT1504000	
SEDIMENT AGGREGATE FILTER 39-G9FP00000				1-1/2" W/250 MESH		39-NT15SC250	
TANK FILTER				1-1/2" W/500 MESH		39-NT15SC500	
IRON FILTER BIRM W/9"		39-G9BP00000		2" W/140 MESH		39-NT2S0140P	
TASTE & ODOR W/9"		39-G9CP00000		2" W/100 MESH		39-NT2SC1000	
ACID WATER NEUTRALIZER W/9"		39-G9NP00000		2" W/250 MESH		39-NT2SC2500	
CHEMICAL PUMP 115 VOLT 15 GAL. SOLUTION TANK 39-CT1241150 39-CST150000				2" W/500 MESH		39-NT2SC5000	
REPLACEMENT FILTER CARTRIDGE				VU FLOW FILTER REPLACEMENT CARTRIDGE			
AQUA GUARD CARTRIDGE		39-NTCG10000		1" W/140 MESH		39-NT100140P	
AQUA GUARD		39-NTS100000		1-1/4" W/160 MESH		39-NT120SC60	
AMETEK		39-NTP250000		1-1/2" W/100 MESH		39-NT60SC100	
2-1/2" W/5 MICRON		39-EFP500000		1-1/2" W/40 MESH		39-NT60SC400	
				1-1/2" NT W/600 MESH		39-NT60SC600	
				1-1/2" NT W/500 MESH		39-NT60SC500	

TITAN INDUSTRIES, INC.
a world of products for the world of water

*Prices are subject to change without notice.
Returns are subject to a restock fee.
Special Orders are non-returnable.*

WATER SOFTENERS, FILTERS & ACCESSORIES

Item	Size	Part No.	List Price	Item	Size	Part No.	List Price
CHLORINATOR		39-CHLH20SFT					
GAS CHLORINATOR							
REGAL MODEL 210 25PPD W/5A		39-2102505A0					
REGAL MODEL 210 50PPD W/17A		39-2105017A0					
REGAL MODEL 216 25PPD W/5A		39-2162505A0					
CHLORINE							
4# GRANULAR		39-CHLGRN004					
5# PELLETS		39-CHLPEL005					
2# TABLETS		39-CHLTAB002					
4# TABLETS		39-CHLTAB004					
10# PELLETS		39-CHLTAB010					
14# TABLETS		39-CHLTAB014					
25# TABLETS		39-CHLTAB025					
35# TABLETS		39-CHLTAB035					
100# TABLETS		39-CHLTAB100					
TEST KIT CN-66		39-CHLTEST66					
REAGENT SET FOR CN-66		39-CHLTETREA					

TITAN INDUSTRIES, INC.
a world of products for the world of water

*Prices are subject to change without notice.
 Returns are subject to a restock fee.
 Special Orders are non-returnable.*

ENVIRONMENTAL ACCESSORIES

Item	Size	Part No.	List Price	Item	Size	Part No.	List Price
AUGER PLUG	4-1/4"	57-AUGER4250		J-PLUG MORRISON	2"	57-JPLUG2000	
	6-1/4"	57-AUGER6250			4"	57-JPLUG4000	
	8-1/4"	57-AUGER8250			6"	57-JPLUG6000	
CENTRALIZER ADJUSTABLE STAINLESS STEEL CAGE TYPE	3/4"	57-CENTS0073		J-PLUG KOBY	1" 40/80	57-JPLUG1S48	
	1"	57-CENTS0103			2" 40	57-JPLUG2SC4	
	1-1/4"	57-CENTS0123			2" 80	57-JPLUG2SC8	
	1-1/2"	57-CENTS0153			2-1/2"40/80	57-JPLUG25S4	
	2"	57-CENTS0204			4" 40	57-JPLUG4SC4	
	2-1/2"	57-CENTS0254		J-PLUG MISC.	1" PIEZO	57-JPLUG1000	
	3"	57-CENTS0304			2" MWSS	57-JPLUG20MW	
	4"	57-CENTS0404		BLUE "T" CAP	2"	57-BTCAP2000	
	4-1/2"	57-CENTS0454			4"	57-BTCAP4000	
	5"	57-CENTS0504			5"	57-BTCAP5000	
	6"	57-CENTS0604			6"	57-BTCAP6000	
	8"	57-CENTS0804			SS KEY	57-BTCAPSKY	
	10"	57-CENTS1004			LOCKING WELL CAP MORRISON WATERTIGHT	2"	57-MORR178XA
	12"	57-CENTS1204		4"		57-MORR305XA	
14"	57-CENTS1404		LOCKING WELL CAP CAST ALUMINUM	2"	57-DB0202000		
16"	57-CENTS1604			4"	57-DB0404000		
CENTRALIZER ADJUSTABLE STAINLESS STEEL CAGE TYPE HEAVY DUTY	10"	OMGCENTRLH100			5"	57-DB0505000	
	12-3/4"	57-CENTHD127			6"	57-DB0606000	
	14"	OMGCENTRLH140			8"	57-DB0808000	
	16"	57-CENTHD164			10"	57-DB1010000	
				12"	57-DB1212000		
CENTRALIZER PVC CAGE TYPE	2"	OMGCENTRL203		ALUMINUM CAP	5-9/16"	57-VC5000000	
	4"	OMGCENTRL404			6-5/8"	57-VC6000000	
	5"	OMGCENTRL504			7"	57-VC7000000	
	6"	OMGCENTRL604		8-5/8"	57-VC8000000		
	8"	OMGCENTRL804		KAM KAP	2"	57-KAMKAP200	
			4"		57-KAMKAP400		
CENTRALIZER PVC TUBE TYPE HEAVY DUTY OFFSET	1-1/2"	OMGCENTSTP015		CANTILEVER EXP PLUG	4" SS	57-JPLCANT04	
	2" - 2-1/2"	OMGCENTSTP025			SNAP CAP PVC	2"	57-SNAP02000
	3" - 3-1/2"	OMGCENTSTP035		4"		57-SNAP04000	
	5"	OMGCENTSTR050		PADLOCK	COATED	57-PADLOCKCT	
CENTRALIZER PVC TUBE TYPE HEAVY DUTY OFFSET	2" - 2-1/2"	OMGCENTSTPH02			DOLPHIN	57-PADLOCKDP	
	3" - 3-1/2"	OMGCENTSTPH03			HAMPTON	57-PADLOKHAM	
	4" - 4-1/2"	OMGCENTSTPH04		MASTERLOCK	130KAD	57-PADLOKMBR	
5" - 5-1/2"	OMGCENTSTPH05		KEYED ALIKE		57-PADLOKMSS		
6" - 6-1/2"	OMGCENTSTPH06		SS SHIELD		57-PADLOKMTR		
INTERNAL PIPE CUTTER	2"	57-INTPIPCU2		REPLACEMENT BLADES	2"	57-INTPIPBL2	
	4"	57-INTPIPCU4			4"	57-INTPIPBL4	
REPLACEMENT BLADES	2"	57-INTPIPBL2		REPLACEMENT SPRINGS	2"	57-INTPIPSG2	
	4"	57-INTPIPBL4			4"	57-INTPIPSG4	

TITAN INDUSTRIES, INC.
a world of products for the world of water

*Prices are subject to change without notice.
Returns are subject to a restock fee.
Special Orders are non-returnable.*

ENVIRONMENTAL ACCESSORIES

Item	Size	Part No.	List Price	Item	Size	Part No.	List Price
FILTERSOCK 100' ROLLS PRICE PER FOOT	1"	57-SOCK10000		FLUSH JOINT HOLDING CLAMP	4"	57-JKFJCLM40	
	2"	57-SOCK20000			5"	57-JKFJCLM50	
	4"	57-SOCK40000			6"	57-JKFJCLM60	
	6"	57-SOCK60000			8"	57-JKFJCLM80	
	8"	57-SOCK80000					
	12"	57-SOCK12000					
				PIPE CLEVIS CLAMP	1-1/4" - 2"	57-ZPICLEVIS	
ENVIROFLEX SQ FOOT PRICES	W/WEBBING	57-EFLEXWEBB					
	NO WEBBING	57-EFLEXWEBL					
MATERIAL ROLLS ARE 14-1/2'							
DISPOSABLE BAILERS							
1.6" X 42" CW WEIGHTED		57-BAIL1.642					
1" X 3' AQUA		57-BAILA0130					
1.6"X3'DBL WGHTEA AQUA		57-BAILAH013					
1-1/4" X 36" PVC GATOR		57-BAILG0123					
3/4" X 3' VOSS		57-BAILV0073					
1-1/4" X 3' VOSS		57-BAILV0123					
BAILER KIT TO USE WITH SCH40 PIPE	1"	57-BAILKT010					
	1-1/4"	57-BAILKT012					
	1-1/2"	57-BAILKT015					
	2"	57-BAILKT020					
	3"	57-BAILKT030					
WHALER PUMP							
921 12V SUPERSUB		57-12GP9216B					
12VDC SUPER PURGER		57-12VDCWP60					
921 SUPER-INLINE 12V		57-12VMHLRPU					
921 BOOSTER IN-LINE 12V		57-12VMHLRPV					
OIL EATER							
1.25" O.D. X 20" LENGTH		57-OILEATERS					
POREX PIPE							
2" X 48" AIR SPARGE POINTS		57-PORXPIP02					
AIR SPARGE POINT							
PVC 2" X REQUIRED LENGTH		57-AIRSPARG2					
SAMPLING TUBE							
1-3/4" X 45-1/2" SPLIT SPOON		57-SMPLTBCLR					
CORE BOXES							
NX-NQ CORE BOXES		57-COREBOXES					
VISQUEEN							
20' X 100' (6M)		57-VISQUEN20					
SITE MARKER							
		57-SITEMARKR					
SCH40 FJ CARBON STEEL ENDS							
	2" FJ	57-CSFJEND20					
	4" FJ	57-CSFJEND40					
	6" MALE FJ	57-CSFJEND60					
SCH40 FLUSH JOINT STAINLESS STEEL ENDS							
	2" FEMALE	57-SSFJEND2F					
	2" MALE	57-SSFJEND2M					
	4" FEMALE	57-SSFJEND4F					
	4" MALE	57-SSFJEND4M					
DUST CAP BLACK							
	1-1/2"	57-DCBLK1500					
	2"	57-DCBLK2000					
	2-1/2"	57-DCBLK2500					
DUST CAP BLUE							
	1"	57-DCBLUE100					
	1-1/4"	57-DCBLUE125					
	1-1/2"	57-DCBLUE150					
	2"	57-DCBLUE200					
	3"	57-DCBLUE300					
	4"	57-DCBLUE400					
	5"	57-DCBLUE500					
	6"	57-DCBLUE600					
DUST CAP OPEN END BLUE							
	1"	57-DCOEBLUE1					
	1-1/2"	57-DCOEBLK15					
	4"	57-DCOEBLUE4					
	5"	57-DCOEBLUE5					
	6"	57-DCOEBLUE6					
DUST CAP ORANGE							
	1-1/4"	57-DCORNG125					
	1-1/2"	57-DCORNG150					
	2" LONG	57-DCORNG20L					
	2" SHORT	57-DCORNG20S					

TITAN INDUSTRIES, INC.
a world of products for the world of water

*Prices are subject to change without notice.
Returns are subject to a restock fee.
Special Orders are non-returnable.*

WELL PROTECTORS & MANHOLES

Item	Size	Part No.	List Price	Item	Size	Part No.	List Price
SQUARE STEEL LOCKING WELL PROTECTOR	4" X 48"	58-SSWP44480		MANHOLE GASKET	7"	58-GAS700000	
	4" X 60"	58-SSWP44600			8"	58-GAS800000	
	4" X 72"	58-SSWP44720			12"	58-GAS120000	
	4" X 84"	58-SSWP44840		MANHOLE SKIRTING	6" WIDE	58-GSKIRT060	
	6" X 48"	58-SSWP66480			10" WIDE	58-GSKIRT100	
	6" X 60"	58-SSWP66600		ROUND STEEL GUARD POST	3" X 5'	58-GRDPST035	
	6" X 72"	58-SSWP66720			3" X 6'	58-GRDPST036	
	6" X 84"	58-SSWP66840		MWSS MANHOLE	12" X 8"	58-3112X8000	
	8" X 48"	58-SSWP88480			CAST IRON MANHOLE	4" X 6-1/2"	58-IES040065
	8" X 60"	58-SSWP88600			8" X 7-1/2"	58-IES080075	
	8" X 72"	58-SSWP88720		DEETER ROUND MANHOLE	27"	58-DEETMAN27	
	10" X 48"	58-SSWP10480			MANHOLE ROUND MANHOLE (SPR ASST.)	30" X 10"	58-510930X10
10" X 60"	58-SSWP10600						
MORRISON MANHOLE COVER	7" X 10"	58-418XA7100					
	8" X 12"	58-418XA8120					
	9" X 7"	58-418XA9700					
	9" X 12"	58-418XA9120					
	12" X 7"	58-418XA1270					
	12" X 12"	58-418XA1212					
	18" X 12"	58-418XA1812					
18" X 18"	58-418XA1818						
KNOCK-DOWN MANHOLE COVER	20"	58-20KNCKCOV					
	24"	58-24CASTIRN					
	24" X 24"	58-418XA2424					
TITAN PVC SKIRT MANHOLE COVER	7" X 10"	58-327XA1100					
	8" X 8"	58-328XA8000					
	8" X 12"	58-328XA1200					
	12" X 8"	58-3212XA800					
12" X 12"	58-3212XA120						
TITAN GALVANIZED SKIRT MANHOLE	7" X 10" GALV	58-327XB1100					
	8" X 8" GALV	58-328XB8000					
	8" X 12" GALV	58-328XB1200					
	12" X 8" GALV	58-3212XB800					
	12" X 12" GALV	58-3212XB120					
TITAN STEEL WELD ON SKIRT MANHOLE	8" X 8"	58-328XD8000					
	8" X 12"	58-328XD1200					
	12" X 8"	58-3212XD800					
	12" X 12"	58-3212XD120					
UNFINISHED LID &/OR RING	7" L&R	58-327XL&R00					
	7" LID ONLY	58-327XLID00					
	7" RING ONLY	58-327XRING0					
	8" L&R	58-328XL&R00					
	8" LID ONLY	58-328XLID00					
	8" RING ONLY	58-328XRING0					
	12" L&R	58-3212XL&R0					
	12" LID ONLY	58-3212XLID0					
	12" RING ONLY	58-3212XRING					

TITAN INDUSTRIES, INC.
a world of products for the world of water

*Prices are subject to change without notice.
Returns are subject to a restock fee.
Special Orders are non-returnable.*

FLUSH THREADED CASING & SCREEN

Part No.	Item Casing, Screen, Caps, Plugs, & Points	List Price			
		2-1/2' XX=02	5' XX=05	10 Ft. XX=10	20 Ft. XX=20
FJC005SC80XXP	1/2" SCH80 CASING 8TPI				
FJS005SC80XXP	1/2" SCH80 STANDARD SCREEN 8TPI **				
HIF005SC80XXP	1/2" SCH80 HI-FLO SCREEN 8TPI ***				
OMG005SC80F8	1/2" SCH80 FLUSH THREAD FEMALE CAP 8TPI				
OMG005SC80M8	1/2" SCH80 FLUSH THREAD MALE PLUG 8TPI				
OMG005SC80P8	1/2" SCH80 FLUSH THREAD POINT 8TPI				
FJC007SC80XXP	3/4" SCH80 CASING 8TPI				
FJS007SC80XXP	3/4" SCH80 STANDARD SCREEN 8TPI **				
HIF007SC80XXP	3/4" SCH80 HI-FLO SCREEN 8TPI ***				
OMG007SC80F8	3/4" SCH80 FLUSH THREAD FEMALE CAP 8TPI				
OMG007SC80M8	3/4" SCH80 FLUSH THREAD MALE PLUG 8TPI				
OMG007SC80P8	3/4" SCH80 FLUSH THREAD POINT 8TPI				
FJC010SC40XXP	1" SCH40 CASING 8TPI				
FJS010SC40XXP	1" SCH40 STANDARD SCREEN 8TPI **				
HIF010SC40XXP	1" SCH40 HI-FLO SCREEN 8TPI ***				
OMG010SC40F8	1" SCH40 FLUSH THREAD FEMALE CAP 8TPI				
OMG010SC40M8	1" SCH40 FLUSH THREAD MALE PLUG 8TPI				
OMG010SC40P8	1" SCH40 FLUSH THREAD POINT 8TPI				
FJC010SC80XXP	1" SCH80 CASING 8TPI				
FJS010SC80XXP	1" SCH80 STANDARD SCREEN 8TPI **				
HIF010SC80XXP	1" SCH80 HI-FLO SCREEN 8TPI ***				
OMG010SC80F8	1" SCH80 FLUSH THREAD FEMALE CAP 8TPI				
OMG010SC80M8	1" SCH80 FLUSH THREAD MALE PLUG 8TPI				
OMG010SC80P8	1" SCH80 FLUSH THREAD POINT 8TPI				
FJC012SC40XXP	1-1/4" SCH40 CASING 2TPI				
FJS012SC40XXP	1-1/4" SCH40 STANDARD SCREEN 2TPI **				
HIF012SC40XXP	1-1/4" SCH40 HI-FLO SCREEN 2TPI ***				
OMG012SC40F2	1-1/4" SCH40 FLUSH THREAD FEMALE CAP 2TPI				
OMG012SC40M2	1-1/4" SCH40 FLUSH THREAD MALE PLUG 2TPI				
OMG012SC40P2	1-1/4" SCH40 FLUSH THREAD POINT 2TPI				
FJC012SC80XXP	1-1/4" SCH80 CASING 2TPI				
FJS012SC80XXP	1-1/4" SCH80 STANDARD SCREEN 2TPI **				
HIF012SC80XXP	1-1/4" SCH80 HI-FLO SCREEN 2TPI ***				
OMG012SC80F2	1-1/4" SCH80 FLUSH THREAD FEMALE CAP 2TPI				
OMG012SC80M2	1-1/4" SCH80 FLUSH THREAD MALE PLUG 2TPI				
OMG012SC80P2	1-1/4" SCH80 FLUSH THREAD POINT 2TPI				
FJC015SC40XXP	1-1/2" SCH40 CASING 2TPI				
FJS015SC40XXP	1-1/2" SCH40 STANDARD SCREEN 2TPI **				
HIF015SC40XXP	1-1/2" SCH40 HI-FLO SCREEN 2TPI ***				
OMG015SC40F2	1-1/2" SCH40 FLUSH THREAD FEMALE CAP 2TPI				
OMG015SC40M2	1-1/2" SCH40 FLUSH THREAD MALE PLUG 2TPI				
OMG015SC40P2	1-1/2" SCH40 FLUSH THREAD POINT 2TPI				

TITAN INDUSTRIES, INC.
a world of products for the world of water

*Prices are subject to change without notice.
Returns are subject to a restock fee.
Special Orders are non-returnable.*

FLUSH THREADED CASING & SCREEN

Part No.	Item Casing, Screen, Caps, Plugs, & Points	List Price			
		2-1/2' XX=02	5' XX=05	10 Ft. XX=10	20 Ft. XX=20
FJC015SC80XXP	1-1/2" SCH80 CASING 2TPI				
FJS015SC80XXP	1-1/2" SCH80 STANDARD SCREEN 2TPI **				
HIF015SC80XXP	1-1/2" SCH80 HI-FLO SCREEN 2TPI ***				
OMG015SC80F2	1-1/2" SCH80 FLUSH THREAD FEMALE CAP 2TPI				
OMG015SC80M2	1-1/2" SCH80 FLUSH THREAD MALE PLUG 2TPI				
OMG015SC80P2	1-1/2" SCH80 FLUSH THREAD POINT 2TPI				
FJC020SC40XXP	2" SCH40 CASING 2TPI				
FJS020SC40XXP	2" SCH40 STANDARD SCREEN 2TPI **				
HIF020SC40XXP	2" SCH40 HI-FLO SCREEN 2TPI ***				
OMG020SC40F2	2" SCH40 FLUSH THREAD FEMALE CAP 2TPI				
OMG020SC40M2	2" SCH40 FLUSH THREAD MALE PLUG 2TPI				
OMG020SC40P2	2" SCH40 FLUSH THREAD POINT 2TPI				
FJC020SC80XXP	2" SCH80 CASING 2TPI				
FJS020SC80XXP	2" SCH80 STANDARD SCREEN 2TPI **				
HIF020SC80XXP	2" SCH80 HI-FLO SCREEN 2TPI ***				
OMG020SC80F2	2" SCH80 FLUSH THREAD FEMALE CAP 2TPI				
OMG020SC80M2	2" SCH80 FLUSH THREAD MALE PLUG 2TPI				
OMG020SC80P2	2" SCH80 FLUSH THREAD POINT 2TPI				
FJC025SC40XXP	2-1/2" SCH40 CASING 2TPI				
FJS025SC40XXP	2-1/2" SCH40 STANDARD SCREEN 2TPI **				
HIF025SC40XXP	2-1/2" SCH40 HI-FLO SCREEN 2TPI ***				
OMG025SC40F2	2-1/2" SCH40 FLUSH THREAD FEMALE CAP 2TPI				
OMG025SC40M2	2-1/2" SCH40 FLUSH THREAD MALE PLUG 2TPI				
FJC025SC80XXP	2-1/2" SCH80 CASING 2TPI				
FJS025SC80XXP	2-1/2" SCH80 STANDARD SCREEN 2TPI **				
HIF025SC80XXP	2-1/2" SCH80 HI-FLO SCREEN 2TPI ***				
OMG025SC80F2	2-1/2" SCH80 FLUSH THREAD FEMALE CAP 2TPI				
OMG025SC80M2	2-1/2" SCH80 FLUSH THREAD MALE PLUG 2TPI				
FJC030SC40XXP	3" SCH40 CASING 2TPI				
FJS030SC40XXP	3" SCH40 STANDARD SCREEN 2TPI **				
HIF030SC40XXP	3" SCH40 HI-FLO SCREEN 2TPI ***				
OMG030SC40F2	3" SCH40 FLUSH THREAD FEMALE CAP 2TPI				
OMG030SC40M2	3" SCH40 FLUSH THREAD MALE PLUG 2TPI				
OMG030SC40P2	3" SCH40 FLUSH THREAD POINT 2TPI				
FJC030SC80XXP	3" SCH80 CASING 2TPI				
FJS030SC80XXP	3" SCH80 STANDARD SCREEN 2TPI **				
HIF030SC80XXP	3" SCH80 HI-FLO SCREEN 2TPI ***				
OMG030SC80F2	3" SCH80 FLUSH THREAD FEMALE CAP 2TPI				
OMG030SC80M2	3" SCH80 FLUSH THREAD MALE PLUG 2TPI				
OMG030SC80P2	3" SCH80 FLUSH THREAD POINT 2TPI				
FJC040SC40XXP	4" SCH40 CASING 2TPI				
FJS040SC40XXP	4" SCH40 STANDARD SCREEN 2TPI **				
HIF040SC40XXP	4" SCH40 HI-FLO SCREEN 2TPI ***				
OMG040SC40F2	4" SCH40 FLUSH THREAD FEMALE CAP 2TPI				
OMG040SC40M2	4" SCH40 FLUSH THREAD MALE PLUG 2TPI				
OMG040SC40P2	4" SCH40 FLUSH THREAD POINT 2TPI				

TITAN INDUSTRIES, INC.
a world of products for the world of water

Prices are subject to change without notice.

Returns are subject to a restock fee.

Special Orders are non-returnable.

FLUSH THREADED CASING & SCREEN

Part No.	Item Casing, Screen, Caps, Plugs, & Points	List Price			
		2-1/2' XX=02	5' XX=05	10 Ft. XX=10	20 Ft. XX=20
FJC040SC80XXP	4" SCH80 CASING 2TPI				
FJS040SC80XXP	4" SCH80 STANDARD SCREEN 2TPI **				
HIF040SC80XXP	4" SCH80 HI-FLO SCREEN 2TPI ***				
OMG040SC80F2	4" SCH80 FLUSH THREAD FEMALE CAP 2TPI				
OMG040SC80M2	4" SCH80 FLUSH THREAD MALE PLUG 2TPI				
OMG040SC80P2	4" SCH80 FLUSH THREAD POINT 2TPI				
FJC045SC40XXP	4-1/2" SCH40 CASING 2TPI				
FJS045SC40XXP	4-1/2" SCH40 STANDARD SCREEN 2TPI **				
HIF045SC40XXP	4-1/2" SCH40 HI-FLO SCREEN 2TPI ***				
OMG045SC40F2	4-1/2" SCH40 FLUSH THREAD FEMALE CAP 2TPI				
OMG045SC40M2	4-1/2" SCH40 FLUSH THREAD MALE PLUG 2TPI				
FJC045SD17XXP	4-1/2" SDR 17 CASING 2TPI				
FJS045SD17XXP	4-1/2" SDR 17 STANDARD SCREEN 2TPI **				
HIF045SD17XXP	4-1/2" SDR 17 HI-FLO SCREEN 2TPI ***				
OMG045SD17F2	4-1/2" SDR 17 FLUSH THREAD FEMALE CAP 2TPI				
OMG045SD17M2	4-1/2" SDR 17 FLUSH THREAD MALE PLUG 2TPI				
FJC050SC40XXP	5" SCH40 CASING 2TPI				
FJS050SC40XXP	5" SCH40 STANDARD SCREEN 2TPI **				
HIF050SC40XXP	5" SCH40 HI-FLO SCREEN 2TPI ***				
OMG050SC40F2	5" SCH40 FLUSH THREAD FEMALE CAP 2TPI				
OMG050SC40M2	5" SCH40 FLUSH THREAD MALE PLUG 2TPI				
FJC050SD21XXP	5" SDR 21 (200#) CASING 2TPI				
FJS050SD21XXP	5" SDR 21 (200#) STANDARD SCREEN 2TPI **				
HIF050SD21XXP	5" SDR 21 (200#) HI-FLO SCREEN 2TPI ***				
OMG050SD21F2	5" SDR 21 (200#) FLUSH THREAD FEMALE CAP 2TPI				
OMG050SD21M2	5" SDR 21 (200#) FLUSH THREAD MALE PLUG 2TPI				
FJC050SD17XXP	5" SDR 17 (250#) CASING 2TPI				
FJS050SD17XXP	5" SDR 17 (250#) STANDARD SCREEN 2TPI **				
HIF050SD17XXP	5" SDR 17 (250#) HI-FLO SCREEN 2TPI ***				
OMG050SD17F2	5" SDR 17 (250#) FLUSH THREAD FEMALE CAP 2TPI				
OMG050SD17M2	5" SDR 17 (250#) FLUSH THREAD MALE PLUG 2TPI				
FJC050SC80XXP	5" SCH80 CASING 2TPI				
FJS050SC80XXP	5" SCH80 STANDARD SCREEN 2TPI **				
HIF050SC80XXP	5" SCH80 HI-FLO SCREEN 2TPI ***				
OMG050SC80F2	5" SCH80 FLUSH THREAD FEMALE CAP 2TPI				
OMG050SC80M2	5" SCH80 FLUSH THREAD MALE PLUG 2TPI				
FJC060SC40XXP	6" SCH40 CASING 2TPI				
FJS060SC40XXP	6" SCH40 STANDARD SCREEN 2TPI **				
HIF060SC40XXP	6" SCH40 HI-FLO SCREEN 2TPI ***				
OMG060SC40F2	6" SCH40 FLUSH THREAD FEMALE CAP 2TPI				
OMG060SC40M2	6" SCH40 FLUSH THREAD MALE PLUG 2TPI				

TITAN INDUSTRIES, INC.
a world of products for the world of water

*Prices are subject to change without notice.
Returns are subject to a restock fee.
Special Orders are non-returnable.*

FLUSH THREADED CASING & SCREEN

Part No.	Item Casing, Screen, Caps, Plugs, & Points	List Price			
		2-1/2' XX=02	5' XX=05	10 Ft. XX=10	20 Ft. XX=20
FJC060SD21XXP	6" SDR 21 (200#) CASING 2TPI				
FJS060SD21XXP	6" SDR 21 (200#) STANDARD SCREEN 2TPI **				
HIF060SD21XXP	6" SDR 21 (200#) HI-FLO SCREEN 2TPI ***				
OMG060SD21F2	6" SDR 21 (200#) FLUSH THREAD FEMALE CAP 2TPI				
OMG060SD21M2	6" SDR 21 (200#) FLUSH THREAD MALE PLUG 2TPI				
FJC060SD17XXP	6" SDR 17 (250#) CASING 2TPI				
FJS060SD17XXP	6" SDR 17 (250#) STANDARD SCREEN 2TPI **				
HIF060SD17XXP	6" SDR 17 (250#) HI-FLO SCREEN 2TPI ***				
OMG060SD17F2	6" SDR 17 (250#) FLUSH THREAD FEMALE CAP 2TPI				
OMG060SD17M2	6" SDR 17 (250#) FLUSH THREAD MALE PLUG 2TPI				
FJC060SC80XXP	6" SCH80 CASING 2TPI				
FJS060SC80XXP	6" SCH80 STANDARD SCREEN 2TPI **				
HIF060SC80XXP	6" SCH80 HI-FLO SCREEN 2TPI ***				
OMG060SC80F2	6" SCH80 FLUSH THREAD FEMALE CAP 2TPI				
OMG060SC80M2	6" SCH80 FLUSH THREAD MALE PLUG 2TPI				
FJC080SC40XXP	8" SCH40 CASING 2TPI				
FJS080SC40XXP	8" SCH40 STANDARD SCREEN 2TPI **				
HIF080SC40XXP	8" SCH40 HI-FLO SCREEN 2TPI ***				
OMG080SC40F2	8" SCH40 FLUSH THREAD FEMALE CAP 2TPI				
OMG080SC40M2	8" SCH40 FLUSH THREAD MALE PLUG 2TPI				
FJC080SD21XXP	8" SDR 21 (200#) CASING 2TPI				
FJS080SD21XXP	8" SDR 21 (200#) STANDARD SCREEN 2TPI **				
HIF080SD21XXP	8" SDR 21 (200#) HI-FLO SCREEN 2TPI ***				
OMG080SD21F2	8" SDR 21 (200#) FLUSH THREAD FEMALE CAP 2TPI				
OMG080SD21M2	8" SDR 21 (200#) FLUSH THREAD MALE PLUG 2TPI				
FJC080SC80XXP	8" SCH80 CASING 2TPI				
FJS080SC80XXP	8" SCH80 STANDARD SCREEN 2TPI **				
HIF080SC80XXP	8" SCH80 HI-FLO SCREEN 2TPI ***				
OMG080SC80F2	8" SCH80 FLUSH THREAD FEMALE CAP 2TPI				
OMG080SC80M2	8" SCH80 FLUSH THREAD MALE PLUG 2TPI				
FJC100SC40XXP	10" SCH40 CASING 2TPI				
FJS100SC40XXP	10" SCH40 STANDARD SCREEN 2TPI **				
HIF100SC40XXP	10" SCH40 HI-FLO SCREEN 2TPI ***				
OMG100SC40F2	10" SCH40 FLUSH THREAD FEMALE CAP 2TPI				
OMG100SC40M2	10" SCH40 FLUSH THREAD MALE PLUG 2TPI				
FJC100SD26XXP	10" SDR26 (160#) CASING 2TPI				
FJS100SD26XXP	10" SDR26 (160#) STANDARD SCREEN 2TPI **				
OMG100SD26F2	10" SDR26 (160#) FLUSH THREAD FEMALE CAP 2TPI				
OMG100SD26M2	10" SDR26 (160#) FLUSH THREAD MALE PLUG 2TPI				
FJC100SD21XXP	10" SDR21 (200#) CASING 2TPI				
FJS100SD21XXP	10" SDR21 (200#) STANDARD SCREEN 2TPI **				
OMG100SD21F2	10" SDR21 (200#) FLUSH THREAD FEMALE CAP 2TPI				
OMG100SD21M2	10" SDR21 (200#) FLUSH THREAD MALE PLUG 2TPI				

TITAN INDUSTRIES, INC.
a world of products for the world of water

Prices are subject to change without notice.

Returns are subject to a restock fee.

Special Orders are non-returnable.

FLUSH THREADED CASING & SCREEN

Part No.	Item Casing, Screen, Caps, Plugs, & Points	List Price			
		2-1/2' XX=02	5' XX=05	10 Ft. XX=10	20 Ft. XX=20
FJC100SC80XXP	10" SCH80 CASING 2TPI				
FJS100SC80XXP	10" SCH80 STANDARD SCREEN 2TPI **				
OMG100SC80F2	10" SCH80 FLUSH THREAD FEMALE CAP 2TPI				
OMG100SC80M2	10" SCH80 FLUSH THREAD MALE PLUG 2TPI				
FJC120SC40XXP	12" SCH40 CASING 2TPI				
FJS120SC40XXP	12" SCH40 STANDARD SCREEN 2TPI **				
HIF120SC40XXP	12" SCH40 HI-FLO SCREEN 2TPI ***				
OMG120SC40F2	12" SCH40 FLUSH THREAD FEMALE CAP 2TPI				
OMG120SC40M2	12" SCH40 FLUSH THREAD MALE PLUG 2TPI				
FJC120SD26XXP	12" SDR26 (160#) CASING 2TPI				
FJS120SD26XXP	12" SDR26 (160#) STANDARD SCREEN 2TPI **				
OMG120SD26F2	12" SDR26 (160#) FLUSH THREAD FEMALE CAP 2TPI				
OMG120SD26M2	12" SDR26 (160#) FLUSH THREAD MALE PLUG 2TPI				
FJC120SD21XXP	12" SDR21 (200#) CASING 2TPI				
FJS120SD21XXP	12" SDR21 (200#) STANDARD SCREEN 2TPI **				
OMG120SD21F2	12" SDR21 (200#) FLUSH THREAD FEMALE CAP 2TPI				
OMG120SD21M2	12" SDR21 (200#) FLUSH THREAD MALE PLUG 2TPI				
FJC120SC80XXP	12" SCH80 CASING 2TPI				
FJS120SC80XXP	12" SCH80 STANDARD SCREEN 2TPI **				
OMG120SC80F2	12" SCH80 FLUSH THREAD FEMALE CAP 2TPI				
OMG120SC80M2	12" SCH80 FLUSH THREAD MALE PLUG 2TPI				
FJC140SC40XXP	14" SCH40 CASING 2TPI				
FJS140SC40XXP	14" SCH40 STANDARD SCREEN 2TPI **				
OMG140SC40F2	14" SCH40 FLUSH THREAD FEMALE CAP 2TPI				
OMG140SC40M2	14" SCH40 FLUSH THREAD MALE PLUG 2TPI				
FJC140SC80XXP	14" SCH80 CASING 2TPI				
FJS140SC80XXP	14" SCH80 STANDARD SCREEN 2TPI **				
OMG140SC80F2	14" SCH80 FLUSH THREAD FEMALE CAP 2TPI				
OMG140SC80M2	14" SCH80 FLUSH THREAD MALE PLUG 2TPI				
FJC160SC40XXP	16" SCH40 CASING 2TPI				
FJS160SC40XXP	16" SCH40 STANDARD SCREEN 2TPI **				
OMG160SC40F2	16" SCH40 FLUSH THREAD FEMALE CAP 2TPI				
OMG160SC40M2	16" SCH40 FLUSH THREAD MALE PLUG 2TPI				
FJC160SD26XXP	16" SDR26 (160#) CASING 2TPI				
FJS160SD26XXP	16" SDR26 (160#) STANDARD SCREEN 2TPI **				
OMG160SD26F2	16" SDR26 (160#) FLUSH THREAD FEMALE CAP 2TPI				
OMG160SD26M2	16" SDR26 (160#) FLUSH THREAD MALE PLUG 2TPI				
FJC160SD21XXP	16" SDR21 (200#) CASING 2TPI				
FJS160SD21XXP	16" SDR21 (200#) STANDARD SCREEN 2TPI **				
OMG160SD21F2	16" SDR21 (200#) FLUSH THREAD FEMALE CAP 2TPI				
OMG160SD21M2	16" SDR21 (200#) FLUSH THREAD MALE PLUG 2TPI				

TITAN INDUSTRIES, INC.
a world of products for the world of water

*Prices are subject to change without notice.
Returns are subject to a restock fee.
Special Orders are non-returnable.*

FLUSH THREADED CASING & SCREEN

Part No.	Item Casing, Screen, Caps, Plugs, & Points	List Price			
		2-1/2' XX=02	5' XX=05	10 Ft. XX=10	20 Ft. XX=20
FJC160SC80XXP	16" SCH80 CASING 2TPI				
FJS160SC80XXP	16" SCH80 STANDARD SCREEN 2TPI **				
OMG160SC80F2	16" SCH80 FLUSH THREAD FEMALE CAP 2TPI				
OMG160SC80M2	16" SCH80 FLUSH THREAD MALE PLUG 2TPI				
FJC180SC40XXP	18" SCH40 CASING 2TPI				
FJS180SC40XXP	18" SCH40 STANDARD SCREEN 2TPI **				
OMG180SC40F2	18" SCH40 FLUSH THREAD FEMALE CAP 2TPI				
OMG180SC40M2	18" SCH40 FLUSH THREAD MALE PLUG 2TPI				
FJC180SC80XXP	18" SCH80 CASING 2TPI				
FJS180SC80XXP	18" SCH80 STANDARD SCREEN 2TPI **				
OMG180SC80F2	18" SCH80 FLUSH THREAD FEMALE CAP 2TPI				
OMG180SC80M2	18" SCH80 FLUSH THREAD MALE PLUG 2TPI				

MOST LENGTHS NOTED ARE ACTUAL MADE UP LENGTHS. FOR SIZE 4-1/2" AND LARGER, EVERY EFFORT WILL BE MADE TO PROVIDE SETTING LENGTHS. HOWEVER, DUE TO THE LEAD TIMES REQUIRED TO HAVE PVC EXTRUDED IN LONGER THAN STANDARD LENGTHS, SOMETIMES WE MAY HAVE TO PROVIDE OVERALL LENGTHS.

LENGTHS OTHER THAN THOSE NOTED AND SOME SPECIALTY FABRICATION ARE PRODUCED UPON REQUEST.

SELECT FROM TWO SCREEN OPTIONS:

** STANDARD SCREEN IS 1/4" DISTANCE BETWEEN SLOTS. SLOT SIZES AVAILABLE ARE: .008", .010", .012", .016", .018", .020", .025", .032", .035", .040", .050", .060", .080", .100", .125", .150", .200", .250".

OTHER SIZES MAY BE AVAILABLE WITH ADDITIONAL LEAD TIME.

*** HI-FLO SCREEN IS 1/8" DISTANCE BETWEEN SLOTS. SLOT SIZES AVAILABLE ARE: .008", .010", .012", .016", .018", .020", .025", .032", .035", .040". OTHER SIZES MAY BE AVAILABLE WITH ADDITIONAL LEAD TIME.

OTHER SLOT SIZES AND SPACINGS ARE AVAILABLE IN MANY SIZES. SLOTTING CAN BE ON ONLY A PORTION OF A LENGTH.

SPECIAL DETERGENT RINSES, BAGGING, WRAPPING OR OTHER OPTIONAL PACKAGING CAN BE SUPPLIED, IF REQUIRED.

ALL SIZES ARE ALSO AVAILABLE IN 4TPI (THREADS PER INCH), PLEASE SPECIFY.
REPLACE THE LAST DIGIT IN THE PART NUMBER A 4 FOR 4TPI.

REPLACE THE XX IN THE PART NUMBER WITH THE APPROPRIATE LENGTH.

Large Diameter Flush Joint Screens & Casings can be individually wrapped upon request. Charges for this special service are determined on a case-by-case basis depending upon such factors as type of packaging required, quantity involved, and relevant shipping requirements.

Prices are subject to change without notice.

Returns are subject to a restock fee.

Special Orders are non-returnable.

TITAN INDUSTRIES, INC.
a world of products for the world of water

NOTES

CALL US TODAY!

PO Box 308
East Hwy 30
Paxton, Nebraska 69155
800-658-4086
308-239-4281
308-239-4474 (fax)

11555 S. Highway 283
Dodge City, Kansas 67801
800-658-4078
620-225-6201
620-225-1171 (fax)

1203 S.E. Grand Blvd.
Oklahoma, City, Oklahoma 73129
800-749-8659
405-677-1290
405-677-1296 (fax)

112 Grant - Aurora Industrial Park
Aurora, Nebraska 68818
800-255-4188
402-694-4188
402-694-4511 (fax)

1912 West Harry
Wichita, Kansas 67213
866-323-9111
316-262-9111
316-262-9119 (fax)

TITAN INDUSTRIES, INC.
a world of products for the world of water